

TPS383x 150-nA, Ultralow Power, Supply Voltage Monitor

1 Features

- Ultralow Supply Current: 150 nA (Typical)
- Operating Supply Voltage: 0.9 V to 6.5 V
- Valid Reset for $V_{DD} > 0.6$ V
- Push-Pull $\overline{\text{RESET}}$ Output
- Factory-Trimmed Reset Threshold Voltages
- Temperature Range: -40°C to 85°C
- Packages: 1-mm x 1-mm X2SON or 3-Pin SOT23

2 Applications

- Portable and Battery-Powered Equipment
- Metering
- Industrial Equipment
- Cell Phones
- Glucose Monitors
- Tablets
- Wearables

3 Description

The TPS3831 and TPS3839 devices (both referred to as *TPS383x*) are ultralow current (150 nA, typical), voltage supervisory circuits that monitor a single voltage. Both devices initiate an active-low reset signal whenever the V_{DD} supply voltage drops below the factory-trimmed reset threshold voltage. The reset output remains low for 200 ms (typical) after the V_{DD} voltage rises above the threshold voltage and hysteresis. These devices are designed to ignore fast transients on the VDD pin. The TPS3831 device includes a manual reset input that forces $\overline{\text{RESET}}$ low when MR is low.

The ultralow current consumption of 150 nA makes these voltage supervisors ideal for use in low-power and portable applications. The TPS383x devices are specified to have the correct output logic state for supply voltages down to 0.6 V.

The TPS383x devices feature precision factory-trimmed threshold voltages and extremely low-power operation. The TPS3831 device is available in a 4-pin, 1-mm x 1-mm (DQN) X2SON package. The TPS3839 device is available in a 3-pin SOT23 (DBZ) package or a 4-pin, 1-mm x 1-mm (DQN) X2SON package.

Device Information⁽¹⁾

PART NUMBER	PACKAGE	PACKAGE SIZE (NOM)
TPS3831	X2SON (4)	1.00 mm x 1.00 mm
TPS3839	SOT-23 (3)	2.92 mm x 2.37 mm
	X2SON (4)	1.00 mm x 1.00 mm

(1) For all available packages, see the orderable addendum at the end of the data sheet.

Typical Application Circuit

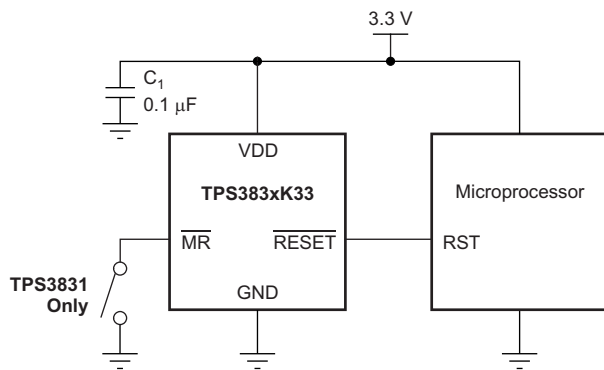

Supply Current vs Temperature

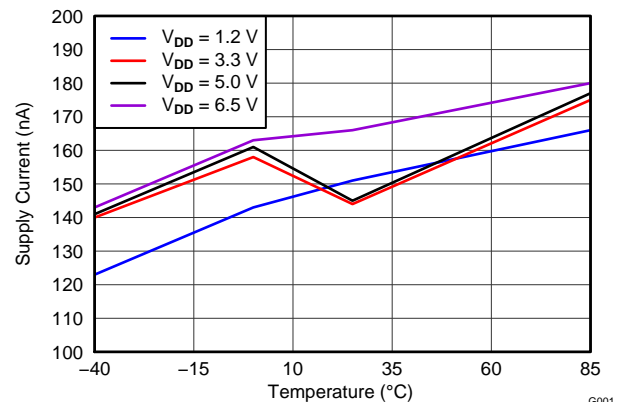

G001



Table of Contents

1 Features	1	8.4 Device Functional Modes	12
2 Applications	1	9 Applications and Implementation	13
3 Description	1	9.1 Application Information	13
4 Revision History	2	9.2 Typical Application	13
5 Device Options	4	10 Power Supply Recommendations	15
6 Pin Configuration and Functions	5	11 Layout	15
7 Specifications	6	11.1 Layout Guidelines	15
7.1 Absolute Maximum Ratings	6	11.2 Layout Example	15
7.2 ESD Ratings	6	12 Device and Documentation Support	16
7.3 Recommended Operating Conditions	6	12.1 Device Support	16
7.4 Thermal Information	6	12.2 Documentation Support	16
7.5 Electrical Characteristics	7	12.3 Related Links	16
7.6 Timing Requirements	8	12.4 Community Resources	16
7.7 Typical Characteristics	9	12.5 Trademarks	16
8 Detailed Description	11	12.6 Electrostatic Discharge Caution	16
8.1 Overview	11	12.7 Glossary	17
8.2 Functional Block Diagram	11	13 Mechanical, Packaging, and Orderable Information	17
8.3 Feature Description	11		

4 Revision History

NOTE: Page numbers for previous revisions may differ from page numbers in the current version.

Changes from Revision C (February 2015) to Revision D	Page
• Changed μA to nA in document title	1
• Added TPS3839G25 to document	1
• Changed <i>Applications</i> section: moved <i>Metering</i> bullet to second in list, changed <i>Tablets</i> bullet, added <i>Wearables</i> bullet ..	1
• Changed first paragraph of <i>Description</i> section	1
• Changed <i>Device Information</i> table: changed Package Size column heading and value of SOT-23 row	1
• Added TPS3839G25 row to <i>Device Options</i> table	4
• Changed <i>Thermal Information</i> table	6
• Changed V_{IT-} and V_{hys} parameters in Electrical Characteristics table: changed test conditions, added TPS3839G25 rows	7

Changes from Revision B (April 2013) to Revision C	Page
• Added <i>ESD Ratings</i> table, <i>Feature Description</i> section, <i>Device Functional Modes</i> , <i>Application and Implementation</i> section, <i>Power Supply Recommendations</i> section, <i>Layout</i> section, <i>Device and Documentation Support</i> section, and <i>Mechanical, Packaging, and Orderable Information</i> section	1
• Changed title of data sheet	1
• Changed Operating Supply Voltage bullet from 0.6 V to 0.9 V	1
• Changed last sentence of <i>Description</i> section	1
• Changed front page figure	1
• Added $\overline{\text{MR}}$ parameter to <i>Absolute Maximum Ratings</i>	6
• Changed condition statement for <i>Electrical Characteristics</i>	7
• Changed $V_{(VO)}$ parameter symbol to V_{POR}	7
• Changed Figure 1	8
• Changed <i>Functional Block Diagram</i> ; added hysteresis symbol to op amp	11
• Deleted <i>Typical Application Circuit</i> figure	13

Changes from Revision A (September 2012) to Revision B **Page**

- Changed V_{DD} test conditions for high-level output voltage parameter **7**
-

Changes from Original (June 2012) to Revision A **Page**

- Changed data sheet status from product preview to production data..... **1**
-

5 Device Options

PRODUCT	THRESHOLD VOLTAGE (V)	PACKAGE-LEAD	PACKAGE DESIGNATOR ⁽¹⁾
TPS3831A09	0.9	X2SON-4	DQN
TPS3831G12	1.1	X2SON-4	DQN
TPS3831E16	1.52	X2SON-4	DQN
TPS3831G18	1.67	X2SON-4	DQN
TPS3831L30	2.63	X2SON-4	DQN
TPS3831K33	2.93	X2SON-4	DQN
TPS3831G33	3.08	X2SON-4	DQN
TPS3831K50	4.38	X2SON-4	DQN
TPS3839A09	0.9	SOT23-3	DBZ
		X2SON-4	DQN
TPS3839G12	1.1	SOT23-3	DBZ
		X2SON-4	DQN
TPS3839E16	1.52	SOT23-3	DBZ
		X2SON-4	DQN
TPS3839G18	1.67	SOT23-3	DBZ
		X2SON-4	DQN
TPS3839G25	2.325	SOT23-3	DBZ
TPS3839L30	2.63	SOT23-3	DBZ
		X2SON-4	DQN
TPS3839K33	2.93	SOT23-3	DBZ
		X2SON-4	DQN
TPS3839G33	3.08	SOT23-3	DBZ
		X2SON-4	DQN
TPS3839K50	4.38	SOT23-3	DBZ
		X2SON-4	DQN

(1) For the most current package and ordering information see the Package Option Addendum at the end of this document, or visit the device product folder at www.ti.com.

6 Pin Configuration and Functions

TPS3831 DQN Package
1-mm × 1-mm X2SON
Top View

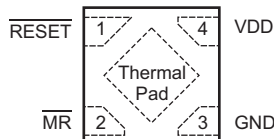

TPS3839 DQN Package
1-mm × 1-mm X2SON
Top View

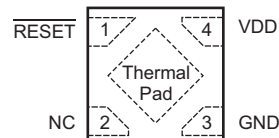

TPS3839 DBZ Package
SOT23-3
Top View

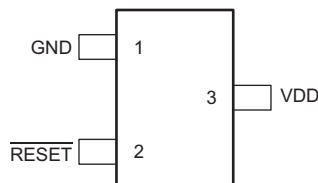

Pin Functions

NAME	PIN NO.			I/O	DESCRIPTION
	TPS3839 (SOT23-3)	TPS3839 (X2SON)	TPS3831 (X2SON)		
GND	1	3	3	—	Ground
$\overline{\text{MR}}$	N/A	N/A	2	I	Manual reset. Pull this pin to a logic low to assert the $\overline{\text{RESET}}$ output. After the $\overline{\text{MR}}$ pin is deasserted, the $\overline{\text{RESET}}$ output deasserts after the reset delay (t_d) elapses.
NC	N/A	2	N/A	—	No internal connection.
$\overline{\text{RESET}}$	2	1	1	O	Active-low reset output. $\overline{\text{RESET}}$ has a push-pull output drive and is capable of directly driving input pins. $\overline{\text{RESET}}$ is low as long as V_{DD} remains below the factory threshold voltage, and until the delay time (t_d) elapses after V_{DD} rises above the threshold voltage.
Thermal pad	N/A	Available	Available	—	Connect to ground or to a floating copper plane for mechanical stability.
VDD	3	4	4	I	Supply voltage

7 Specifications

7.1 Absolute Maximum Ratings

over operating free-air temperature range, unless otherwise noted⁽¹⁾

		MIN	MAX	UNIT
Voltage	V _{DD} , $\overline{\text{RESET}}$	-0.3	7	V
	$\overline{\text{MR}}$	-0.3	V _{DD} + 0.3	V
Current	$\overline{\text{RESET}}$ pin	-10	10	mA
Temperature ⁽²⁾	Operating ambient, T _A	-40	85	°C
	Storage, T _{stg}	-65	150	

- (1) Stresses beyond those listed under *Absolute Maximum Ratings* may cause permanent damage to the device. These are stress ratings only, and functional operation of the device at these or any other conditions beyond those indicated under *Recommended Operating Conditions* is not implied. Exposure to absolute-maximum-rated conditions for extended periods may affect device reliability.
- (2) As a result of the low dissipated power in this device, the junction temperature is assumed to be equal to the ambient temperature.

7.2 ESD Ratings

		VALUE	UNIT
V _(ESD)	Electrostatic discharge	Human body model (HBM), per ANSI/ESDA/JEDEC JS-001 ⁽¹⁾	±2000
		Charged device model (CDM), per JEDEC specification JESD22-C101 ⁽²⁾	±500

- (1) JEDEC document JEP155 states that 500-V HBM allows safe manufacturing with a standard ESD control process.
- (2) JEDEC document JEP157 states that 250-V CDM allows safe manufacturing with a standard ESD control process.

7.3 Recommended Operating Conditions

over operating free-air temperature range (unless otherwise noted)

		MIN	NOM	MAX	UNIT
V _{DD}	Input supply voltage	0.9		6.5	V
V _{MR}	Manual reset pin voltage	0		V _{DD}	V
V _{RESET}	$\overline{\text{RESET}}$ pin voltage	0		6.5	V
I _{RESET}	$\overline{\text{RESET}}$ pin current	0		8	mA

7.4 Thermal Information

THERMAL METRIC ⁽¹⁾		TPS3839	TPS3831, TPS3839	UNIT
		DBZ (SOT23-3)	DQN (X2SON)	
		3 PINS	4 PINS	
R _{θJA}	Junction-to-ambient thermal resistance	346.6	216.1	°C/W
R _{θJC(top)}	Junction-to-case (top) thermal resistance	124.4	161.7	°C/W
R _{θJB}	Junction-to-board thermal resistance	78.9	162.1	°C/W
ψ _{JT}	Junction-to-top characterization parameter	11.5	5.1	°C/W
ψ _{JB}	Junction-to-board characterization parameter	77.3	161.7	°C/W
R _{θJC(bot)}	Junction-to-case (bottom) thermal resistance	N/A	123.0	°C/W

- (1) For more information about traditional and new thermal metrics, see the *Semiconductor and IC Package Thermal Metrics* application report, [SPRA953](#).

7.5 Electrical Characteristics

At $T_A = -40^\circ\text{C}$ to 85°C , $0.9\text{ V} < V_{DD} < 6.5\text{ V}$, and $C1 = 0.1\ \mu\text{F}$, unless otherwise noted. Typical values are at 25°C .

PARAMETER		TEST CONDITIONS	MIN	TYP	MAX	UNIT
V_{DD}	Input supply voltage		0.9		6.5	V
$V_{(POR)}$	Minimum V_{DD} voltage for valid output	$I_{OL} = 1\ \mu\text{A}$			0.6	V
I_{DD}	Supply current (into V_{DD} pin)	Output not connected		150	500	nA
V_{OL}	Low-level output voltage ($\overline{\text{RESET}}$ pin)	$V_{DD} = 0.9\text{ V}$ to 1.2 V , $I_{OL} = 120\ \mu\text{A}$			0.4	V
		$V_{DD} = 1.2\text{ V}$ to 2.8 V , $I_{OL} = 0.5\text{ mA}$			0.4	
		$V_{DD} = 2.8\text{ V}$ to 6.5 V , $I_{OL} = 2\text{ mA}$			0.4	
V_{OH}	High-level output voltage ($\overline{\text{RESET}}$ pin)	$V_{DD} = 0.9\text{ V}$ to 1.2 V , $I_{OH} = -50\ \mu\text{A}$	$V_{DD} - 0.4$			V
		$V_{DD} = 1.2\text{ V}$ to 3.3 V , $I_{OH} = -0.5\text{ mA}$	$V_{DD} - 0.4$			
		$V_{DD} = 3.3\text{ V}$ to 6.5 V , $I_{OH} = -2\text{ mA}$	$V_{DD} - 0.4$			
V_{IL}	Low-level input voltage ($\overline{\text{MR}}$ pin)		$0.3V_{DD}$			V
V_{IH}	High-level input voltage ($\overline{\text{MR}}$ pin)				$0.7V_{DD}$	V
R_{MR}	MR pin pullup resistance		10	20	30	k Ω
	Negative-going input threshold accuracy	$T_A = 25^\circ\text{C}$		$\pm 1\%$		
V_{IT-}	Negative-going threshold voltage	TPS383xA09	0.874	0.9	0.914	V
		TPS383xG12	1.073	1.1	1.117	
		TPS383xE16	1.482	1.52	1.543	
		TPS383xG18	1.628	1.67	1.695	
		TPS3839G25	2.267	2.325	2.360	
		TPS383xL30	2.564	2.63	2.669	
		TPS383xK33	2.857	2.93	2.974	
		TPS383xG33	3.003	3.08	3.126	
		TPS383xK50	4.271	4.38	4.446	
V_{hys}	Hysteresis voltage	TPS383xA09		54		mV
		TPS383xG12		11		
		TPS383xE16		15		
		TPS383xG18		17		
		TPS383xL30		26		
		TPS3839G25		23		
		TPS383xK33		29		
		TPS383xG33		31		
		TPS383xK50		44		

7.6 Timing Requirements

At $T_A = -40^\circ\text{C}$ to 85°C , $0.9\text{ V} < V_{DD} < 6.5\text{ V}$, and $C1 = 0.1\ \mu\text{F}$, unless otherwise noted. Typical values are at 25°C .

		MIN	TYP	MAX	UNIT
t_d	$\overline{\text{RESET}}$ delay time (power-up delay)	120	200	350	ms
t_{PD_VDD}	Propagation delay, V_{DD} falling (power-down delay)		20		μs
t_{PD_MR}	Propagation delay from $\overline{\text{MR}}$ low to $\overline{\text{RESET}}$ low		46		ns

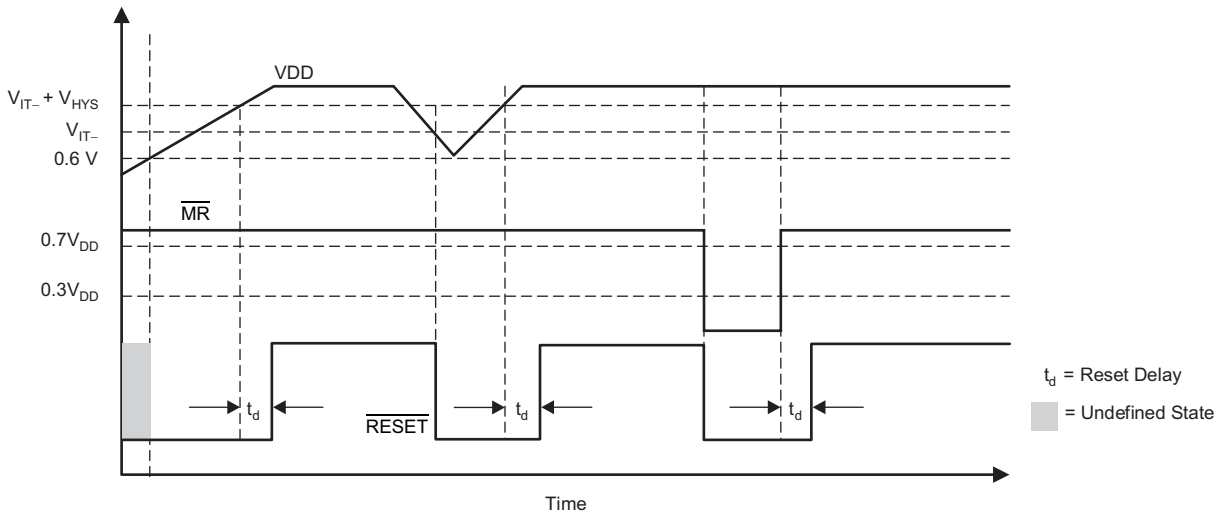

Figure 1. $\overline{\text{MR}}$ and VDD Reset Timing

7.7 Typical Characteristics

At $T_A = 25^\circ\text{C}$ and $C_1 = 0.1 \mu\text{F}$, unless otherwise noted.

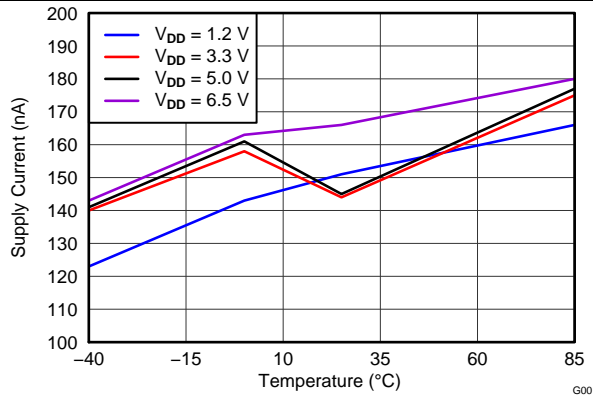

Figure 2. Supply Current vs Temperature

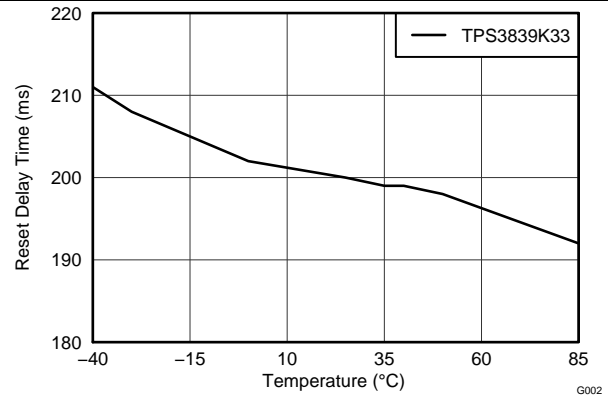

Figure 3. Reset Delay vs Temperature

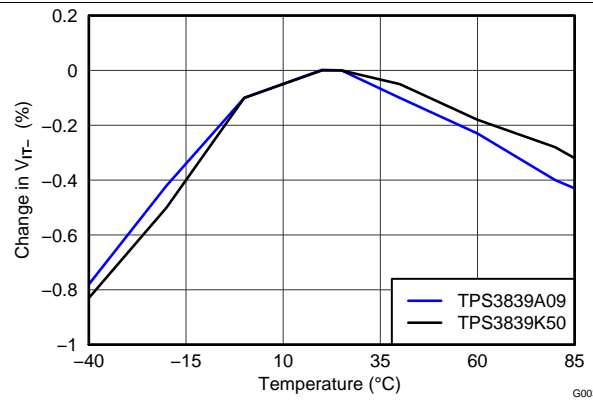

Figure 4. Threshold Voltage vs Temperature

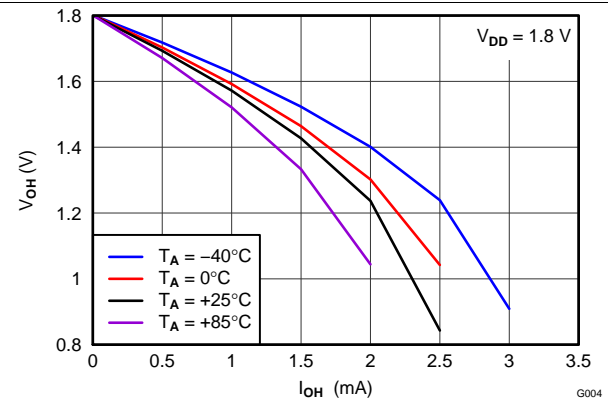

Figure 5. V_{OH} vs I_{OH} and Temperature for $V_{DD} = 1.8 \text{ V}$

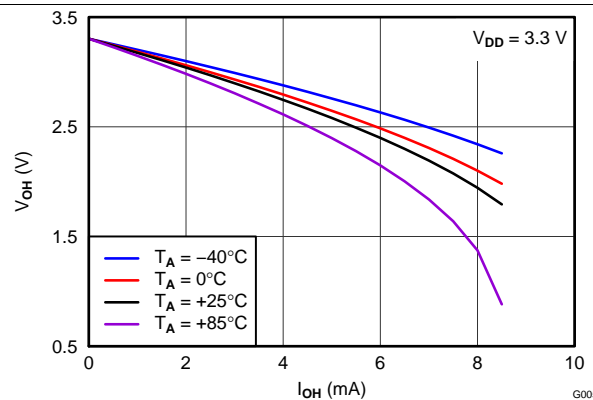

Figure 6. V_{OH} vs I_{OH} and Temperature for $V_{DD} = 3.3 \text{ V}$

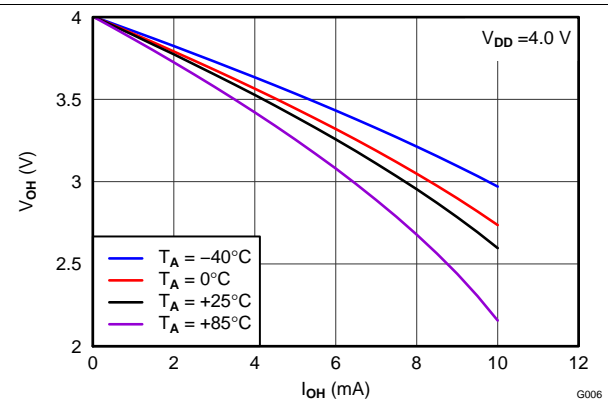

Figure 7. V_{OH} vs I_{OH} and Temperature for $V_{DD} = 4.0 \text{ V}$

Typical Characteristics (continued)

At $T_A = 25^\circ\text{C}$ and $C_1 = 0.1 \mu\text{F}$, unless otherwise noted.

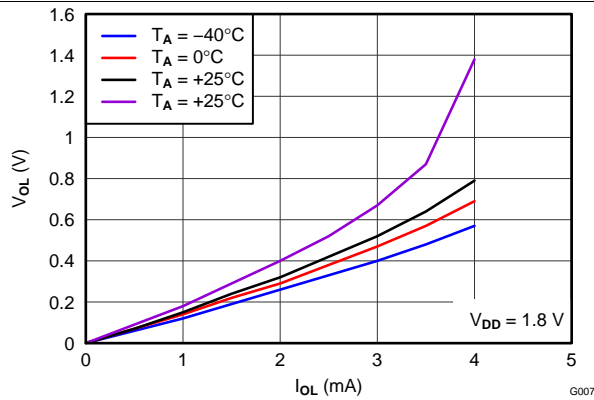

Figure 8. V_{OL} vs I_{OL} and Temperature for $V_{DD} = 1.8 \text{ V}$

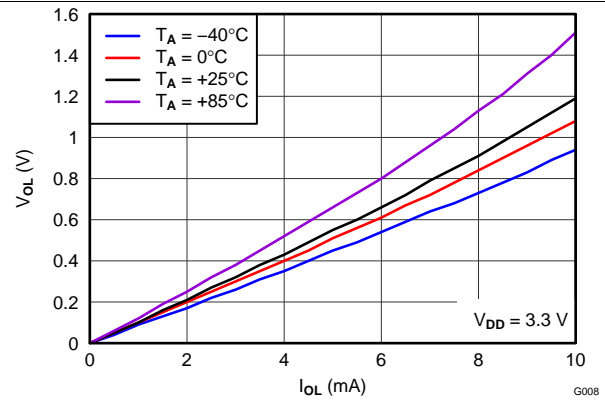

Figure 9. V_{OL} vs I_{OL} and Temperature for $V_{DD} = 3.3 \text{ V}$

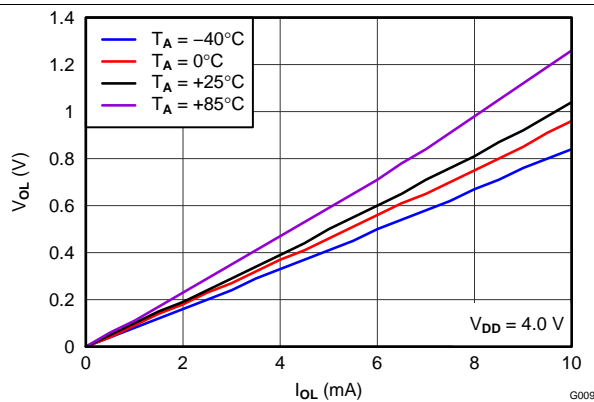

Figure 10. V_{OL} vs I_{OL} and Temperature for $V_{DD} = 4.0 \text{ V}$

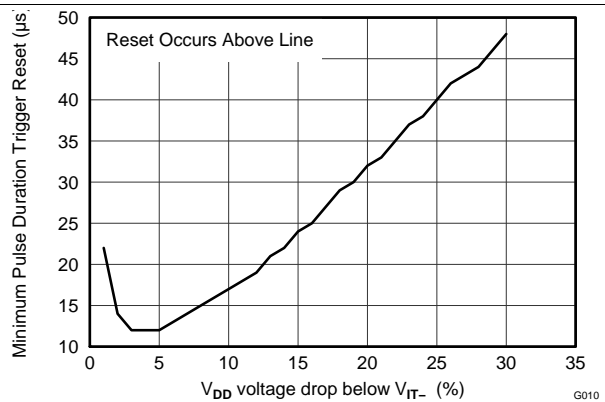

Figure 11. Maximum Pulse Duration vs Percent of Threshold Overdrive

8 Detailed Description

8.1 Overview

The TPS3831 and TPS3839 are ultralow current voltage supervisory circuits that monitor the input supply voltage of these devices. Both devices assert an active-low reset whenever the V_{DD} supply voltage drops below the negative-going threshold voltage (V_{IT-}). The output, \overline{RESET} , remains asserted for approximately 200 ms after the V_{DD} voltage rises above the positive-going threshold voltage ($V_{IT-} + V_{hys}$). These devices are designed to ignore fast transients on the VDD pin.

The TPS3831 device includes a manual reset input (\overline{MR}) that can be used to force the \overline{RESET} signal low, even if the supply voltage is above V_{IT-} .

8.2 Functional Block Diagram

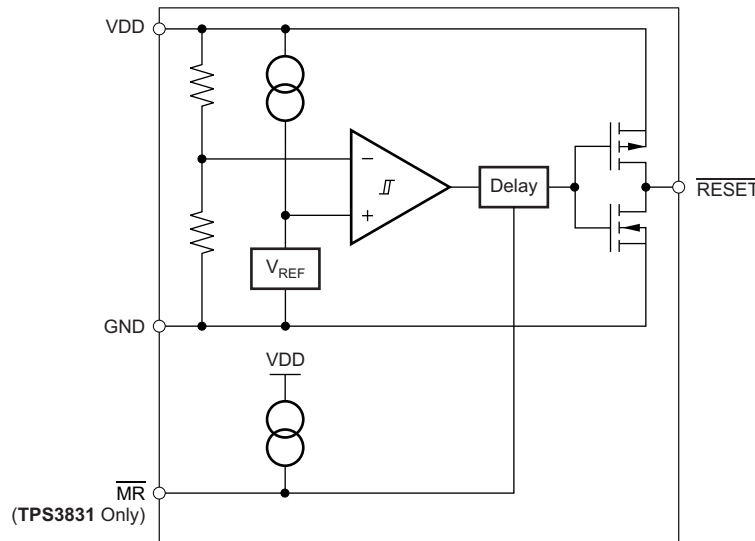

8.3 Feature Description

8.3.1 VDD Transient Rejection

The TPS383x (TPS3831 and TPS3839) devices have built-in rejection of fast transients on the VDD pin. Transient rejection depends on both the duration and amplitude of the transient. Transient amplitude is measured from the bottom of the transient to the negative threshold voltage (V_{IT-}) of the device, as shown in Figure 12.

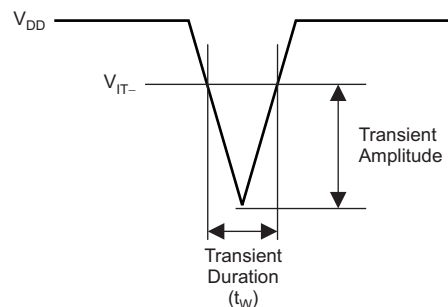

Figure 12. Voltage Transient Measurement

Feature Description (continued)

Figure 13 shows the relationship between the transient amplitude and duration required to trigger a reset. Any combination of duration and amplitude greater than that shown in Figure 13 generates a reset signal.

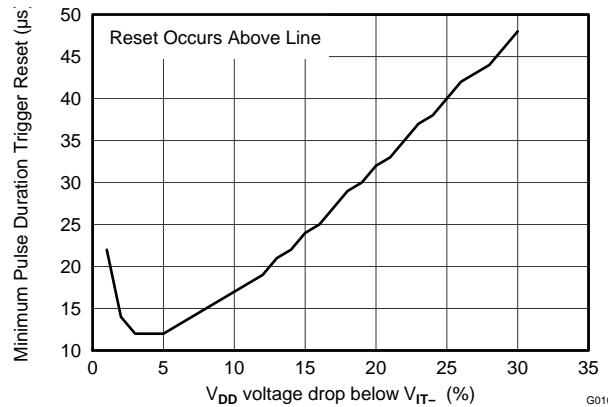

Figure 13. TPS3839 Transient Rejection

8.3.2 Manual Reset ($\overline{\text{MR}}$) Input (TPS3831 Only)

The manual reset ($\overline{\text{MR}}$) input allows a processor, or other logic devices, to initiate a reset (TPS3831 device only). A logic low ($0.3 V_{\text{DD}}$) on $\overline{\text{MR}}$ causes $\overline{\text{RESET}}$ to assert. After $\overline{\text{MR}}$ returns to a logic high and V_{DD} is greater than the threshold voltage, $\overline{\text{RESET}}$ is deasserted after the reset delay time, t_{d} , elapses. $\overline{\text{MR}}$ is internally tied to V_{DD} with a 20-k Ω resistor; therefore, this pin can be left unconnected if $\overline{\text{MR}}$ is not used. If a logic signal driving $\overline{\text{MR}}$ does not go fully to V_{DD} , some additional current draws into V_{DD} as a result of the internal pullup resistor on $\overline{\text{MR}}$. To minimize current draw, a logic-level FET can be used, as shown in Figure 14.

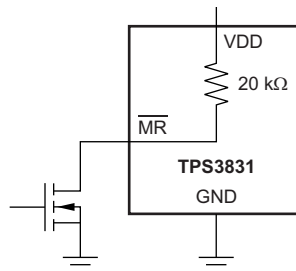

Figure 14. Using a Logic-Level FET to Minimize Current Draw

8.4 Device Functional Modes

8.4.1 Normal Operation ($V_{\text{DD}} > V_{\text{DD}(\text{min})}$)

When the voltage on V_{DD} is greater than $V_{\text{DD}(\text{min})}$, the $\overline{\text{RESET}}$ output corresponds to the voltage on the V_{DD} pin relative to $V_{\text{IT-}}$.

8.4.2 Below $V_{\text{DD}(\text{min})}$ ($V_{(\text{POR})} < V_{\text{DD}} < V_{\text{DD}(\text{min})}$)

When the voltage on V_{DD} is less than $V_{\text{DD}(\text{min})}$ but greater than the power-on reset voltage ($V_{(\text{POR})}$), the $\overline{\text{RESET}}$ output is asserted.

8.4.3 Below Power-On Reset ($V_{\text{DD}} < V_{(\text{POR})}$)

When the voltage on V_{DD} is lower than the power-on reset voltage ($V_{(\text{POR})}$), the $\overline{\text{RESET}}$ output is undefined. Do not rely on the $\overline{\text{RESET}}$ output for proper device function under this condition.

9 Applications and Implementation

NOTE

Information in the following applications sections is not part of the TI component specification, and TI does not warrant its accuracy or completeness. TI's customers are responsible for determining suitability of components for their purposes. Customers should validate and test their design implementation to confirm system functionality.

9.1 Application Information

Low operating voltage and threshold options make the TPS383x devices well-suited for monitoring single-cell, alkaline-battery applications.

9.2 Typical Application

Figure 15 shows the TPS3839A09 used to disable a boost converter when the cell voltage reaches 0.9 V, which is the end of the discharge voltage for a single alkaline battery cell. When the cell voltage reaches 0.9 V, the TPS61261 enable pin is driven low. This setting disables the TPS61261 and places it in a low-current shutdown state. The combination of the TPS3839 and TPS61261 devices consumes only 250 nA (typical) from the discharged battery.

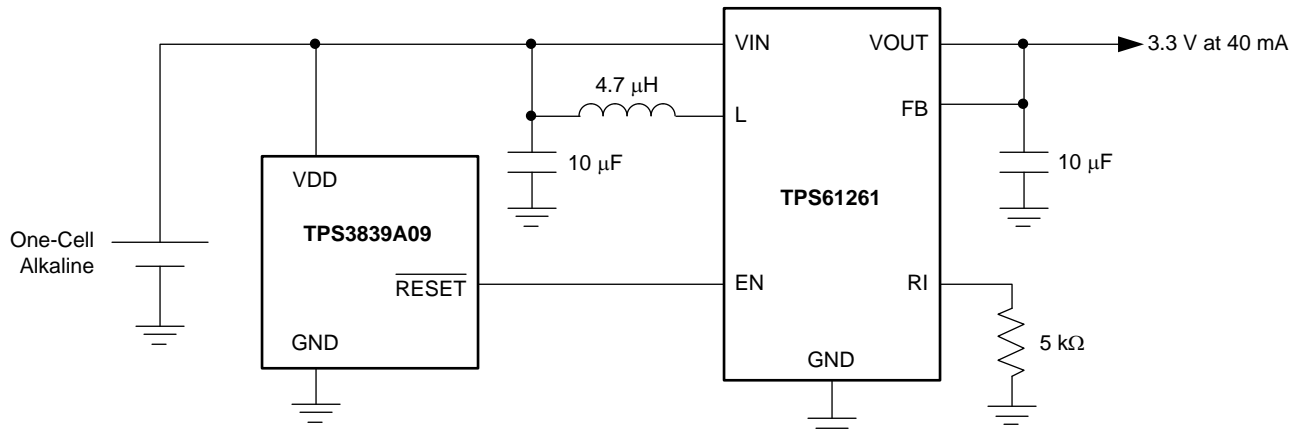

Figure 15. Disabled Boost Converter

9.2.1 Design Requirements

Table 1 lists the design requirements for Figure 15.

Table 1. Design Requirements and Results

DESIGN REQUIREMENTS	DESIGN RESULT		
	TPS3839A09	TPS61261	COMBINED
Input voltage range of 0.9 V to 1.7 V	0.9 V to 6.5 V	0.8 V to 4 V	0.9 V to 4 V
Shutdown current < 3 µA	0.5 µA (maximum)	1.5 µA (maximum)	2.0 µA (maximum)
Output voltage of 3.3 V	N/A	3.3 V	3.3 V
Output current of 50 mA	N/A	100 mA	100 mA
Switching frequency ≥ 1 MHz	N/A	2.5 MHz	2.5 MHz

9.2.2 Detailed Design Procedure

9.2.2.1 Input Capacitor

The TPS383x devices use a unique sampling scheme to maintain an extremely low average quiescent current of 150 nA. The TPS383x devices typically consume only approximately 100 nA of dc current. However, this current rises to approximately 15 μ A for about 200 μ s when the TPS383x devices sample the input voltage. If the source impedance back to the supply voltage is high, then the additional current during sampling may trigger a false reset as a result of the apparent voltage drop at VDD. For applications with high-impedance input supplies (including trace impedance), TI recommends adding a small 0.1- μ F bypass capacitor near the TPS3839 VDD pin. This bypass capacitor effectively keeps the average current at 150 nA and reduces the effects of a high-impedance voltage source.

9.2.2.2 Bidirectional Reset Pins

Some devices have bidirectional reset pins that act both as an input and an output. For applications where the TPS383x devices drive a bidirectional reset pin, place a series resistor between the TPS383x output and the reset pin to protect against excessive current flow when both the TPS383x devices and the reset pin attempt to drive the reset line. Figure 16 shows the connection of the TPS3839K33 to a bidirectional reset pin of a microcontroller using a series resistor.

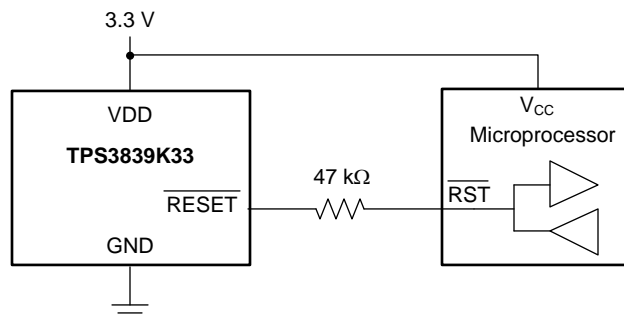

Figure 16. Connection to a Bidirectional Reset Pin

9.2.3 Application Curve

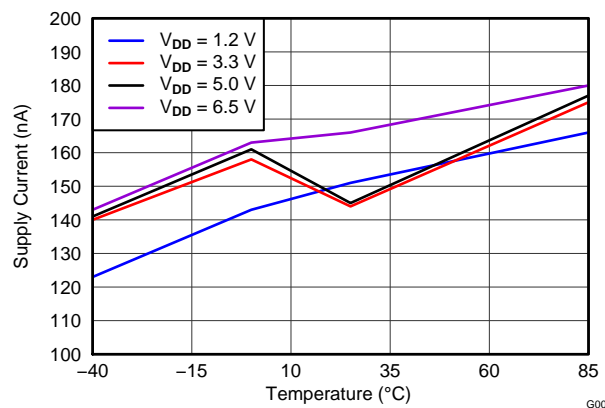

Figure 17. Supply Current vs Temperature

10 Power Supply Recommendations

These devices are designed to operate from an input supply with a voltage range between 0.9 V and 6.5 V. Use a low-impedance power supply to eliminate inaccuracies caused by the extra current during the input-voltage sampling discussed in the [Input Capacitor](#) section.

11 Layout

11.1 Layout Guidelines

Make sure the connection to the VDD pin is low impedance and able to carry 15 μA without a significant voltage drop. Place a 0.1- μF bypass capacitor near the VDD pin if the 15- μA sampling current causes too much voltage droop.

11.2 Layout Example

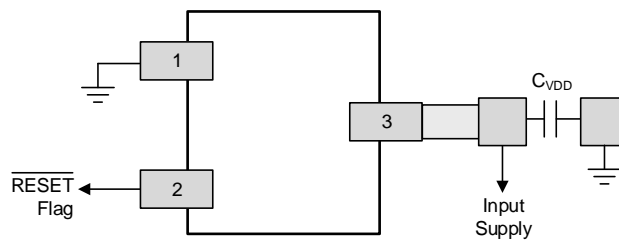

Figure 18. Recommended Layout

12 Device and Documentation Support

12.1 Device Support

12.1.1 Development Support

12.1.1.1 Evaluation Modules

Two evaluation modules (EVMs) are available to assist in the initial circuit performance evaluation using the TPS3831 and TPS3839. The [TPS3831G33EVM-187](#) and [TPS3839K33EVM-112](#) evaluation modules (and related user's guides) can be requested at the TI website through the product folders or purchased directly from the [TI eStore](#).

12.1.1.2 Spice Models

Computer simulation of circuit performance using SPICE is often useful when analyzing the performance of analog circuits and systems. SPICE models for the TPS3831 and TPS3839 devices are available through each of the product folders under *Tools & Software*.

12.2 Documentation Support

12.2.1 Related Documentation

- [TPS3831G33EVM-187 User's Guide, SLVU774](#)
- [TPS3839K33EVM-112 User's Guide, SLVU758](#).
- [TPS61261 Data Sheet, SLVSA99](#)

12.3 Related Links

[Table 2](#) lists quick access links. Categories include technical documents, support and community resources, tools and software, and quick access to sample or buy.

Table 2. Related Links

PARTS	PRODUCT FOLDER	SAMPLE & BUY	TECHNICAL DOCUMENTS	TOOLS & SOFTWARE	SUPPORT & COMMUNITY
TPS3831	Click here	Click here	Click here	Click here	Click here
TPS3839	Click here	Click here	Click here	Click here	Click here

12.4 Community Resources

The following links connect to TI community resources. Linked contents are provided "AS IS" by the respective contributors. They do not constitute TI specifications and do not necessarily reflect TI's views; see TI's [Terms of Use](#).

TI E2E™ Online Community *TI's Engineer-to-Engineer (E2E) Community*. Created to foster collaboration among engineers. At e2e.ti.com, you can ask questions, share knowledge, explore ideas and help solve problems with fellow engineers.

Design Support *TI's Design Support* Quickly find helpful E2E forums along with design support tools and contact information for technical support.

12.5 Trademarks

E2E is a trademark of Texas Instruments.
All other trademarks are the property of their respective owners.

12.6 Electrostatic Discharge Caution



These devices have limited built-in ESD protection. The leads should be shorted together or the device placed in conductive foam during storage or handling to prevent electrostatic damage to the MOS gates.

12.7 Glossary

[SLYZ022](#) — *TI Glossary*.

This glossary lists and explains terms, acronyms, and definitions.

13 Mechanical, Packaging, and Orderable Information

The following pages include mechanical, packaging, and orderable information. This information is the most current data available for the designated devices. This data is subject to change without notice and revision of this document. For browser-based versions of this data sheet, refer to the left-hand navigation.

PACKAGING INFORMATION

Orderable Device	Status (1)	Package Type	Package Drawing	Pins	Package Qty	Eco Plan (2)	Lead finish/ Ball material (6)	MSL Peak Temp (3)	Op Temp (°C)	Device Marking (4/5)	Samples
TPS3831A09DQNR	ACTIVE	X2SON	DQN	4	3000	RoHS & Green	NIPDAU	Level-1-260C-UNLIM	-40 to 85	A3	Samples
TPS3831A09DQNT	ACTIVE	X2SON	DQN	4	250	RoHS & Green	NIPDAU	Level-1-260C-UNLIM	-40 to 85	A3	Samples
TPS3831E16DQNR	ACTIVE	X2SON	DQN	4	3000	RoHS & Green	NIPDAU	Level-1-260C-UNLIM	-40 to 85	A5	Samples
TPS3831E16DQNT	ACTIVE	X2SON	DQN	4	250	RoHS & Green	NIPDAU	Level-1-260C-UNLIM	-40 to 85	A5	Samples
TPS3831G12DQNR	ACTIVE	X2SON	DQN	4	3000	RoHS & Green	NIPDAU	Level-1-260C-UNLIM	-40 to 85	A4	Samples
TPS3831G12DQNT	ACTIVE	X2SON	DQN	4	250	RoHS & Green	NIPDAU	Level-1-260C-UNLIM	-40 to 85	A4	Samples
TPS3831G18DQNR	ACTIVE	X2SON	DQN	4	3000	RoHS & Green	NIPDAU	Level-1-260C-UNLIM	-40 to 85	A6	Samples
TPS3831G18DQNT	ACTIVE	X2SON	DQN	4	250	RoHS & Green	NIPDAU	Level-1-260C-UNLIM	-40 to 85	A6	Samples
TPS3831G33DQNR	ACTIVE	X2SON	DQN	4	3000	RoHS & Green	NIPDAU	Level-1-260C-UNLIM	-40 to 85	A7	Samples
TPS3831G33DQNT	ACTIVE	X2SON	DQN	4	250	RoHS & Green	NIPDAU	Level-1-260C-UNLIM	-40 to 85	A7	Samples
TPS3831K33DQNR	ACTIVE	X2SON	DQN	4	3000	RoHS & Green	NIPDAU	Level-1-260C-UNLIM	-40 to 85	A8	Samples
TPS3831K33DQNT	ACTIVE	X2SON	DQN	4	250	RoHS & Green	NIPDAU	Level-1-260C-UNLIM	-40 to 85	A8	Samples
TPS3831K50DQNR	ACTIVE	X2SON	DQN	4	3000	RoHS & Green	NIPDAU	Level-1-260C-UNLIM	-40 to 85	A9	Samples
TPS3831K50DQNT	ACTIVE	X2SON	DQN	4	250	RoHS & Green	NIPDAU	Level-1-260C-UNLIM	-40 to 85	A9	Samples
TPS3831L30DQNR	ACTIVE	X2SON	DQN	4	3000	RoHS & Green	NIPDAU	Level-1-260C-UNLIM	-40 to 85	BA	Samples
TPS3831L30DQNT	ACTIVE	X2SON	DQN	4	250	RoHS & Green	NIPDAU	Level-1-260C-UNLIM	-40 to 85	BA	Samples
TPS3839A09DBZR	ACTIVE	SOT-23	DBZ	3	3000	RoHS & Green	NIPDAUAG	Level-1-260C-UNLIM	-40 to 85	PZDI	Samples
TPS3839A09DBZT	ACTIVE	SOT-23	DBZ	3	250	RoHS & Green	NIPDAUAG	Level-1-260C-UNLIM	-40 to 85	PZDI	Samples
TPS3839A09DQNR	ACTIVE	X2SON	DQN	4	3000	RoHS & Green	NIPDAU	Level-1-260C-UNLIM	-40 to 85	ZJ	Samples
TPS3839A09DQNT	ACTIVE	X2SON	DQN	4	250	RoHS & Green	NIPDAU	Level-1-260C-UNLIM	-40 to 85	ZJ	Samples

Orderable Device	Status (1)	Package Type	Package Drawing	Pins	Package Qty	Eco Plan (2)	Lead finish/ Ball material (6)	MSL Peak Temp (3)	Op Temp (°C)	Device Marking (4/5)	Samples
TPS3839E16DBZR	ACTIVE	SOT-23	DBZ	3	3000	RoHS & Green	NIPDAUAG	Level-1-260C-UNLIM	-40 to 85	PZCI	Samples
TPS3839E16DBZT	ACTIVE	SOT-23	DBZ	3	250	RoHS & Green	NIPDAUAG	Level-1-260C-UNLIM	-40 to 85	PZCI	Samples
TPS3839E16DQNR	ACTIVE	X2SON	DQN	4	3000	RoHS & Green	NIPDAU	Level-1-260C-UNLIM	-40 to 85	ZK	Samples
TPS3839E16DQNT	ACTIVE	X2SON	DQN	4	250	RoHS & Green	NIPDAU	Level-1-260C-UNLIM	-40 to 85	ZK	Samples
TPS3839G12DBZR	ACTIVE	SOT-23	DBZ	3	3000	RoHS & Green	NIPDAUAG	Level-1-260C-UNLIM	-40 to 85	PZBI	Samples
TPS3839G12DBZT	ACTIVE	SOT-23	DBZ	3	250	RoHS & Green	NIPDAUAG	Level-1-260C-UNLIM	-40 to 85	PZBI	Samples
TPS3839G12DQNR	ACTIVE	X2SON	DQN	4	3000	RoHS & Green	NIPDAU	Level-1-260C-UNLIM	-40 to 85	ZE	Samples
TPS3839G12DQNT	ACTIVE	X2SON	DQN	4	250	RoHS & Green	NIPDAU	Level-1-260C-UNLIM	-40 to 85	ZE	Samples
TPS3839G18DBZR	ACTIVE	SOT-23	DBZ	3	3000	RoHS & Green	NIPDAUAG	Level-1-260C-UNLIM	-40 to 85	PZAI	Samples
TPS3839G18DBZT	ACTIVE	SOT-23	DBZ	3	250	RoHS & Green	NIPDAUAG	Level-1-260C-UNLIM	-40 to 85	PZAI	Samples
TPS3839G18DQNR	ACTIVE	X2SON	DQN	4	3000	RoHS & Green	NIPDAU	Level-1-260C-UNLIM	-40 to 85	ZL	Samples
TPS3839G18DQNT	ACTIVE	X2SON	DQN	4	250	RoHS & Green	NIPDAU	Level-1-260C-UNLIM	-40 to 85	ZL	Samples
TPS3839G25DBZR	ACTIVE	SOT-23	DBZ	3	3000	RoHS & Green	NIPDAU	Level-1-260C-UNLIM	-40 to 85	PZNI	Samples
TPS3839G25DBZT	ACTIVE	SOT-23	DBZ	3	250	RoHS & Green	NIPDAU	Level-1-260C-UNLIM	-40 to 85	PZNI	Samples
TPS3839G33DBZR	ACTIVE	SOT-23	DBZ	3	3000	RoHS & Green	NIPDAUAG	Level-1-260C-UNLIM	-40 to 85	PYZI	Samples
TPS3839G33DBZT	ACTIVE	SOT-23	DBZ	3	250	RoHS & Green	NIPDAUAG	Level-1-260C-UNLIM	-40 to 85	PYZI	Samples
TPS3839G33DQNR	ACTIVE	X2SON	DQN	4	3000	RoHS & Green	NIPDAU	Level-1-260C-UNLIM	-40 to 85	ZG	Samples
TPS3839G33DQNT	ACTIVE	X2SON	DQN	4	250	RoHS & Green	NIPDAU	Level-1-260C-UNLIM	-40 to 85	ZG	Samples
TPS3839K33DBZR	ACTIVE	SOT-23	DBZ	3	3000	RoHS & Green	NIPDAUAG	Level-1-260C-UNLIM	-40 to 85	PYYI	Samples
TPS3839K33DBZT	ACTIVE	SOT-23	DBZ	3	250	RoHS & Green	NIPDAUAG	Level-1-260C-UNLIM	-40 to 85	PYYI	Samples
TPS3839K33DQNR	ACTIVE	X2SON	DQN	4	3000	RoHS & Green	NIPDAU	Level-1-260C-UNLIM	-40 to 85	ZF	Samples

Orderable Device	Status (1)	Package Type	Package Drawing	Pins	Package Qty	Eco Plan (2)	Lead finish/ Ball material (6)	MSL Peak Temp (3)	Op Temp (°C)	Device Marking (4/5)	Samples
TPS3839K33DQNT	ACTIVE	X2SON	DQN	4	250	RoHS & Green	NIPDAU	Level-1-260C-UNLIM	-40 to 85	ZF	Samples
TPS3839K50DBZR	ACTIVE	SOT-23	DBZ	3	3000	RoHS & Green	NIPDAUAG	Level-1-260C-UNLIM	-40 to 85	PYXI	Samples
TPS3839K50DBZT	ACTIVE	SOT-23	DBZ	3	250	RoHS & Green	NIPDAUAG	Level-1-260C-UNLIM	-40 to 85	PYXI	Samples
TPS3839K50DQNR	ACTIVE	X2SON	DQN	4	3000	RoHS & Green	NIPDAU	Level-1-260C-UNLIM	-40 to 85	ZH	Samples
TPS3839K50DQNT	ACTIVE	X2SON	DQN	4	250	RoHS & Green	NIPDAU	Level-1-260C-UNLIM	-40 to 85	ZH	Samples
TPS3839L30DBZR	ACTIVE	SOT-23	DBZ	3	3000	RoHS & Green	NIPDAUAG	Level-1-260C-UNLIM	-40 to 85	PYWI	Samples
TPS3839L30DBZT	ACTIVE	SOT-23	DBZ	3	250	RoHS & Green	NIPDAUAG	Level-1-260C-UNLIM	-40 to 85	PYWI	Samples
TPS3839L30DQNR	ACTIVE	X2SON	DQN	4	3000	RoHS & Green	NIPDAU	Level-1-260C-UNLIM	-40 to 85	ZI	Samples
TPS3839L30DQNT	ACTIVE	X2SON	DQN	4	250	RoHS & Green	NIPDAU	Level-1-260C-UNLIM	-40 to 85	ZI	Samples

(1) The marketing status values are defined as follows:

ACTIVE: Product device recommended for new designs.

LIFEBUY: TI has announced that the device will be discontinued, and a lifetime-buy period is in effect.

NRND: Not recommended for new designs. Device is in production to support existing customers, but TI does not recommend using this part in a new design.

PREVIEW: Device has been announced but is not in production. Samples may or may not be available.

OBSOLETE: TI has discontinued the production of the device.

(2) **RoHS:** TI defines "RoHS" to mean semiconductor products that are compliant with the current EU RoHS requirements for all 10 RoHS substances, including the requirement that RoHS substance do not exceed 0.1% by weight in homogeneous materials. Where designed to be soldered at high temperatures, "RoHS" products are suitable for use in specified lead-free processes. TI may reference these types of products as "Pb-Free".

RoHS Exempt: TI defines "RoHS Exempt" to mean products that contain lead but are compliant with EU RoHS pursuant to a specific EU RoHS exemption.

Green: TI defines "Green" to mean the content of Chlorine (Cl) and Bromine (Br) based flame retardants meet JS709B low halogen requirements of <=1000ppm threshold. Antimony trioxide based flame retardants must also meet the <=1000ppm threshold requirement.

(3) MSL, Peak Temp. - The Moisture Sensitivity Level rating according to the JEDEC industry standard classifications, and peak solder temperature.

(4) There may be additional marking, which relates to the logo, the lot trace code information, or the environmental category on the device.

(5) Multiple Device Markings will be inside parentheses. Only one Device Marking contained in parentheses and separated by a "-" will appear on a device. If a line is indented then it is a continuation of the previous line and the two combined represent the entire Device Marking for that device.

⁽⁶⁾ Lead finish/Ball material - Orderable Devices may have multiple material finish options. Finish options are separated by a vertical ruled line. Lead finish/Ball material values may wrap to two lines if the finish value exceeds the maximum column width.

Important Information and Disclaimer: The information provided on this page represents TI's knowledge and belief as of the date that it is provided. TI bases its knowledge and belief on information provided by third parties, and makes no representation or warranty as to the accuracy of such information. Efforts are underway to better integrate information from third parties. TI has taken and continues to take reasonable steps to provide representative and accurate information but may not have conducted destructive testing or chemical analysis on incoming materials and chemicals. TI and TI suppliers consider certain information to be proprietary, and thus CAS numbers and other limited information may not be available for release.

In no event shall TI's liability arising out of such information exceed the total purchase price of the TI part(s) at issue in this document sold by TI to Customer on an annual basis.

TAPE AND REEL INFORMATION

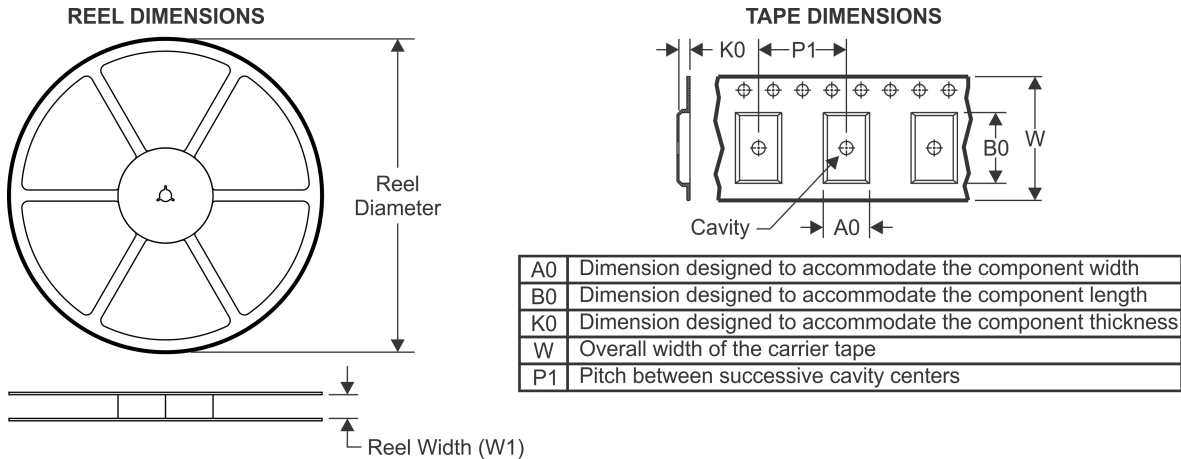

QUADRANT ASSIGNMENTS FOR PIN 1 ORIENTATION IN TAPE

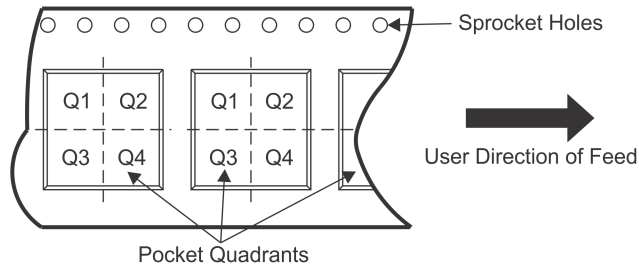

*All dimensions are nominal

Device	Package Type	Package Drawing	Pins	SPQ	Reel Diameter (mm)	Reel Width W1 (mm)	A0 (mm)	B0 (mm)	K0 (mm)	P1 (mm)	W (mm)	Pin1 Quadrant
TPS3831A09DQNR	X2SON	DQN	4	3000	180.0	9.5	1.16	1.16	0.5	4.0	8.0	Q2
TPS3831A09DQNT	X2SON	DQN	4	250	180.0	9.5	1.16	1.16	0.5	4.0	8.0	Q2
TPS3831E16DQNR	X2SON	DQN	4	3000	180.0	9.5	1.16	1.16	0.5	4.0	8.0	Q2
TPS3831E16DQNT	X2SON	DQN	4	250	180.0	9.5	1.16	1.16	0.5	4.0	8.0	Q2
TPS3831G12DQNR	X2SON	DQN	4	3000	180.0	9.5	1.16	1.16	0.5	4.0	8.0	Q2
TPS3831G12DQNT	X2SON	DQN	4	250	180.0	9.5	1.16	1.16	0.5	4.0	8.0	Q2
TPS3831G18DQNR	X2SON	DQN	4	3000	180.0	9.5	1.16	1.16	0.5	4.0	8.0	Q2
TPS3831G18DQNT	X2SON	DQN	4	250	180.0	9.5	1.16	1.16	0.5	4.0	8.0	Q2
TPS3831G33DQNR	X2SON	DQN	4	3000	180.0	9.5	1.16	1.16	0.5	4.0	8.0	Q2
TPS3831G33DQNT	X2SON	DQN	4	250	180.0	9.5	1.16	1.16	0.5	4.0	8.0	Q2
TPS3831K33DQNR	X2SON	DQN	4	3000	180.0	9.5	1.16	1.16	0.5	4.0	8.0	Q2
TPS3831K33DQNT	X2SON	DQN	4	250	180.0	9.5	1.16	1.16	0.5	4.0	8.0	Q2
TPS3831K50DQNR	X2SON	DQN	4	3000	180.0	9.5	1.16	1.16	0.5	4.0	8.0	Q2
TPS3831K50DQNT	X2SON	DQN	4	250	180.0	9.5	1.16	1.16	0.5	4.0	8.0	Q2
TPS3831L30DQNR	X2SON	DQN	4	3000	180.0	9.5	1.16	1.16	0.5	4.0	8.0	Q2
TPS3831L30DQNT	X2SON	DQN	4	250	180.0	9.5	1.16	1.16	0.5	4.0	8.0	Q2
TPS3839A09DBZR	SOT-23	DBZ	3	3000	179.0	8.4	3.15	2.95	1.22	4.0	8.0	Q3
TPS3839A09DBZT	SOT-23	DBZ	3	250	179.0	8.4	3.15	2.95	1.22	4.0	8.0	Q3

Device	Package Type	Package Drawing	Pins	SPQ	Reel Diameter (mm)	Reel Width W1 (mm)	A0 (mm)	B0 (mm)	K0 (mm)	P1 (mm)	W (mm)	Pin1 Quadrant
TPS3839A09DQNR	X2SON	DQN	4	3000	180.0	9.5	1.16	1.16	0.5	4.0	8.0	Q2
TPS3839A09DQNT	X2SON	DQN	4	250	180.0	9.5	1.16	1.16	0.5	4.0	8.0	Q2
TPS3839E16DBZR	SOT-23	DBZ	3	3000	179.0	8.4	3.15	2.95	1.22	4.0	8.0	Q3
TPS3839E16DBZT	SOT-23	DBZ	3	250	179.0	8.4	3.15	2.95	1.22	4.0	8.0	Q3
TPS3839E16DQNR	X2SON	DQN	4	3000	180.0	9.5	1.16	1.16	0.5	4.0	8.0	Q2
TPS3839E16DQNT	X2SON	DQN	4	250	180.0	9.5	1.16	1.16	0.5	4.0	8.0	Q2
TPS3839G12DBZR	SOT-23	DBZ	3	3000	179.0	8.4	3.15	2.95	1.22	4.0	8.0	Q3
TPS3839G12DBZT	SOT-23	DBZ	3	250	179.0	8.4	3.15	2.95	1.22	4.0	8.0	Q3
TPS3839G12DQNR	X2SON	DQN	4	3000	180.0	9.5	1.16	1.16	0.5	4.0	8.0	Q2
TPS3839G12DQNT	X2SON	DQN	4	250	180.0	9.5	1.16	1.16	0.5	4.0	8.0	Q2
TPS3839G18DBZR	SOT-23	DBZ	3	3000	179.0	8.4	3.15	2.95	1.22	4.0	8.0	Q3
TPS3839G18DBZT	SOT-23	DBZ	3	250	179.0	8.4	3.15	2.95	1.22	4.0	8.0	Q3
TPS3839G18DQNR	X2SON	DQN	4	3000	180.0	9.5	1.16	1.16	0.5	4.0	8.0	Q2
TPS3839G18DQNT	X2SON	DQN	4	250	180.0	9.5	1.16	1.16	0.5	4.0	8.0	Q2
TPS3839G25DBZR	SOT-23	DBZ	3	3000	179.0	8.4	3.15	2.95	1.22	4.0	8.0	Q3
TPS3839G25DBZT	SOT-23	DBZ	3	250	179.0	8.4	3.15	2.95	1.22	4.0	8.0	Q3
TPS3839G33DBZR	SOT-23	DBZ	3	3000	179.0	8.4	3.15	2.95	1.22	4.0	8.0	Q3
TPS3839G33DBZT	SOT-23	DBZ	3	250	179.0	8.4	3.15	2.95	1.22	4.0	8.0	Q3
TPS3839G33DQNR	X2SON	DQN	4	3000	180.0	9.5	1.16	1.16	0.5	4.0	8.0	Q2
TPS3839G33DQNT	X2SON	DQN	4	250	180.0	9.5	1.16	1.16	0.5	4.0	8.0	Q2
TPS3839K33DBZR	SOT-23	DBZ	3	3000	179.0	8.4	3.15	2.95	1.22	4.0	8.0	Q3
TPS3839K33DBZT	SOT-23	DBZ	3	250	179.0	8.4	3.15	2.95	1.22	4.0	8.0	Q3
TPS3839K33DQNR	X2SON	DQN	4	3000	180.0	9.5	1.16	1.16	0.5	4.0	8.0	Q2
TPS3839K33DQNT	X2SON	DQN	4	250	180.0	9.5	1.16	1.16	0.5	4.0	8.0	Q2
TPS3839K50DBZR	SOT-23	DBZ	3	3000	179.0	8.4	3.15	2.95	1.22	4.0	8.0	Q3
TPS3839K50DBZT	SOT-23	DBZ	3	250	179.0	8.4	3.15	2.95	1.22	4.0	8.0	Q3
TPS3839K50DQNR	X2SON	DQN	4	3000	180.0	9.5	1.16	1.16	0.5	4.0	8.0	Q2
TPS3839K50DQNT	X2SON	DQN	4	250	180.0	9.5	1.16	1.16	0.5	4.0	8.0	Q2
TPS3839L30DBZR	SOT-23	DBZ	3	3000	179.0	8.4	3.15	2.95	1.22	4.0	8.0	Q3
TPS3839L30DBZT	SOT-23	DBZ	3	250	179.0	8.4	3.15	2.95	1.22	4.0	8.0	Q3
TPS3839L30DQNR	X2SON	DQN	4	3000	180.0	9.5	1.16	1.16	0.5	4.0	8.0	Q2
TPS3839L30DQNT	X2SON	DQN	4	250	180.0	9.5	1.16	1.16	0.5	4.0	8.0	Q2

TAPE AND REEL BOX DIMENSIONS

*All dimensions are nominal

Device	Package Type	Package Drawing	Pins	SPQ	Length (mm)	Width (mm)	Height (mm)
TPS3831A09DQNR	X2SON	DQN	4	3000	184.0	184.0	19.0
TPS3831A09DQNT	X2SON	DQN	4	250	184.0	184.0	19.0
TPS3831E16DQNR	X2SON	DQN	4	3000	184.0	184.0	19.0
TPS3831E16DQNT	X2SON	DQN	4	250	184.0	184.0	19.0
TPS3831G12DQNR	X2SON	DQN	4	3000	184.0	184.0	19.0
TPS3831G12DQNT	X2SON	DQN	4	250	184.0	184.0	19.0
TPS3831G18DQNR	X2SON	DQN	4	3000	184.0	184.0	19.0
TPS3831G18DQNT	X2SON	DQN	4	250	184.0	184.0	19.0
TPS3831G33DQNR	X2SON	DQN	4	3000	184.0	184.0	19.0
TPS3831G33DQNT	X2SON	DQN	4	250	184.0	184.0	19.0
TPS3831K33DQNR	X2SON	DQN	4	3000	184.0	184.0	19.0
TPS3831K33DQNT	X2SON	DQN	4	250	184.0	184.0	19.0
TPS3831K50DQNR	X2SON	DQN	4	3000	184.0	184.0	19.0
TPS3831K50DQNT	X2SON	DQN	4	250	184.0	184.0	19.0
TPS3831L30DQNR	X2SON	DQN	4	3000	184.0	184.0	19.0
TPS3831L30DQNT	X2SON	DQN	4	250	184.0	184.0	19.0
TPS3839A09DBZR	SOT-23	DBZ	3	3000	203.0	203.0	35.0
TPS3839A09DBZT	SOT-23	DBZ	3	250	200.0	183.0	25.0
TPS3839A09DQNR	X2SON	DQN	4	3000	184.0	184.0	19.0
TPS3839A09DQNT	X2SON	DQN	4	250	184.0	184.0	19.0

Device	Package Type	Package Drawing	Pins	SPQ	Length (mm)	Width (mm)	Height (mm)
TPS3839E16DBZR	SOT-23	DBZ	3	3000	200.0	183.0	25.0
TPS3839E16DBZT	SOT-23	DBZ	3	250	200.0	183.0	25.0
TPS3839E16DQNR	X2SON	DQN	4	3000	184.0	184.0	19.0
TPS3839E16DQNT	X2SON	DQN	4	250	184.0	184.0	19.0
TPS3839G12DBZR	SOT-23	DBZ	3	3000	200.0	183.0	25.0
TPS3839G12DBZT	SOT-23	DBZ	3	250	203.0	203.0	35.0
TPS3839G12DQNR	X2SON	DQN	4	3000	184.0	184.0	19.0
TPS3839G12DQNT	X2SON	DQN	4	250	184.0	184.0	19.0
TPS3839G18DBZR	SOT-23	DBZ	3	3000	200.0	183.0	25.0
TPS3839G18DBZT	SOT-23	DBZ	3	250	203.0	203.0	35.0
TPS3839G18DQNR	X2SON	DQN	4	3000	184.0	184.0	19.0
TPS3839G18DQNT	X2SON	DQN	4	250	184.0	184.0	19.0
TPS3839G25DBZR	SOT-23	DBZ	3	3000	200.0	183.0	25.0
TPS3839G25DBZT	SOT-23	DBZ	3	250	200.0	183.0	25.0
TPS3839G33DBZR	SOT-23	DBZ	3	3000	200.0	183.0	25.0
TPS3839G33DBZT	SOT-23	DBZ	3	250	200.0	183.0	25.0
TPS3839G33DQNR	X2SON	DQN	4	3000	184.0	184.0	19.0
TPS3839G33DQNT	X2SON	DQN	4	250	184.0	184.0	19.0
TPS3839K33DBZR	SOT-23	DBZ	3	3000	200.0	183.0	25.0
TPS3839K33DBZT	SOT-23	DBZ	3	250	200.0	183.0	25.0
TPS3839K33DQNR	X2SON	DQN	4	3000	184.0	184.0	19.0
TPS3839K33DQNT	X2SON	DQN	4	250	184.0	184.0	19.0
TPS3839K50DBZR	SOT-23	DBZ	3	3000	200.0	183.0	25.0
TPS3839K50DBZT	SOT-23	DBZ	3	250	203.0	203.0	35.0
TPS3839K50DQNR	X2SON	DQN	4	3000	184.0	184.0	19.0
TPS3839K50DQNT	X2SON	DQN	4	250	184.0	184.0	19.0
TPS3839L30DBZR	SOT-23	DBZ	3	3000	200.0	183.0	25.0
TPS3839L30DBZT	SOT-23	DBZ	3	250	200.0	183.0	25.0
TPS3839L30DQNR	X2SON	DQN	4	3000	184.0	184.0	19.0
TPS3839L30DQNT	X2SON	DQN	4	250	184.0	184.0	19.0

GENERIC PACKAGE VIEW

DBZ 3

SOT-23 - 1.12 mm max height

SMALL OUTLINE TRANSISTOR

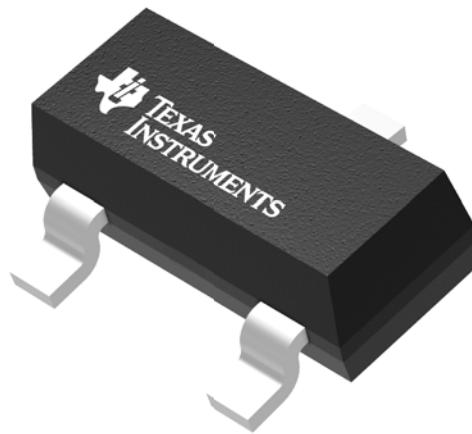

Images above are just a representation of the package family, actual package may vary.
Refer to the product data sheet for package details.

4203227/C

DBZ0003A

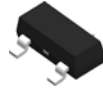

PACKAGE OUTLINE

SOT-23 - 1.12 mm max height

SMALL OUTLINE TRANSISTOR

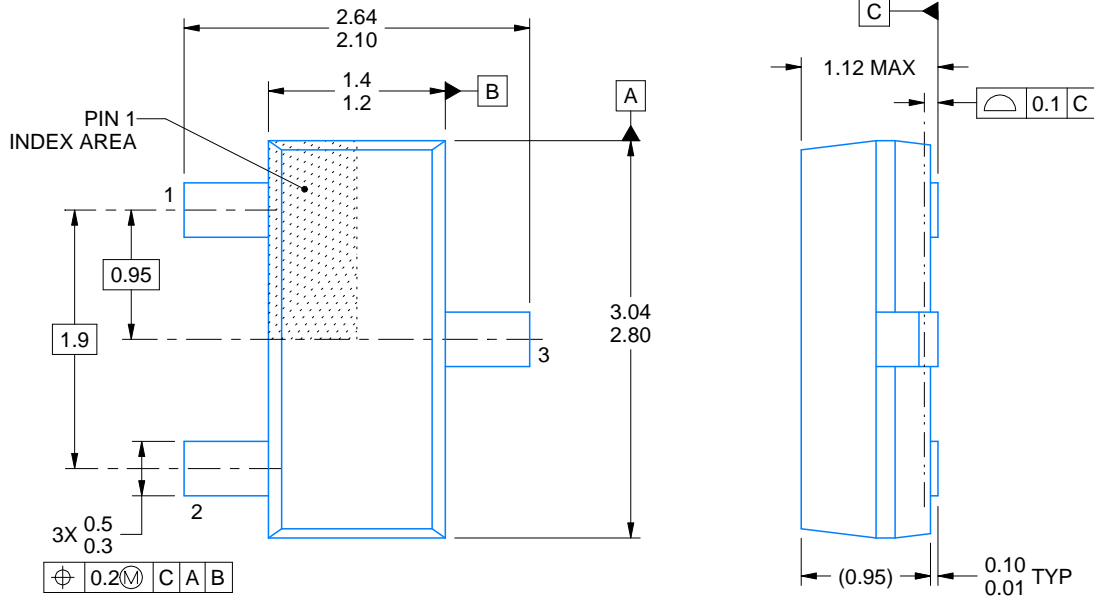

4214838/C 04/2017

NOTES:

1. All linear dimensions are in millimeters. Any dimensions in parenthesis are for reference only. Dimensioning and tolerancing per ASME Y14.5M.
2. This drawing is subject to change without notice.
3. Reference JEDEC registration TO-236, except minimum foot length.

EXAMPLE BOARD LAYOUT

DBZ0003A

SOT-23 - 1.12 mm max height

SMALL OUTLINE TRANSISTOR

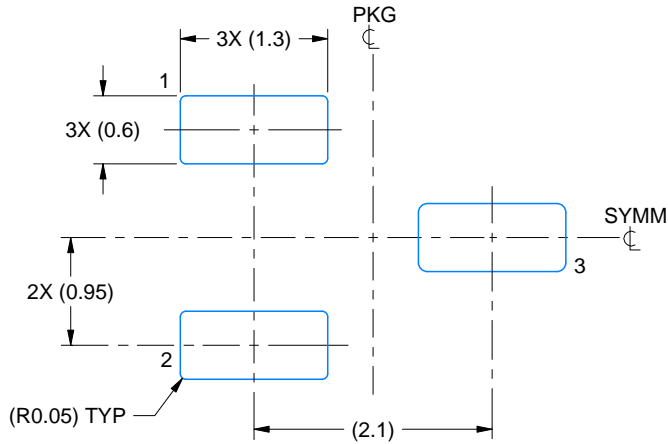

LAND PATTERN EXAMPLE
SCALE:15X

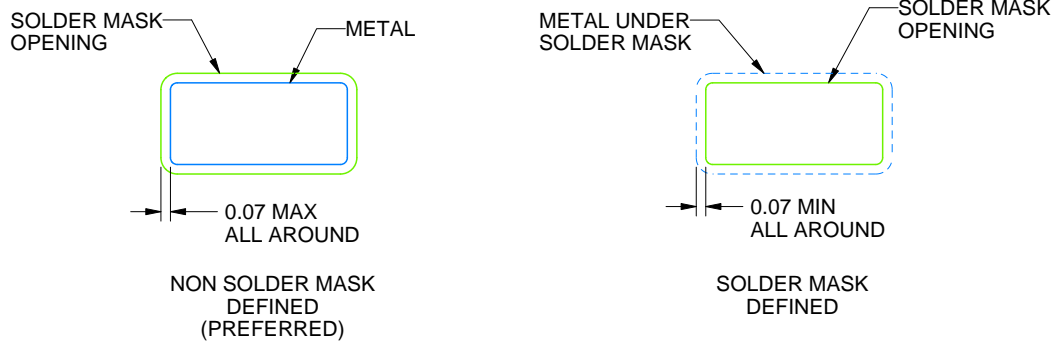

SOLDER MASK DETAILS

4214838/C 04/2017

NOTES: (continued)

4. Publication IPC-7351 may have alternate designs.
5. Solder mask tolerances between and around signal pads can vary based on board fabrication site.

EXAMPLE STENCIL DESIGN

DBZ0003A

SOT-23 - 1.12 mm max height

SMALL OUTLINE TRANSISTOR

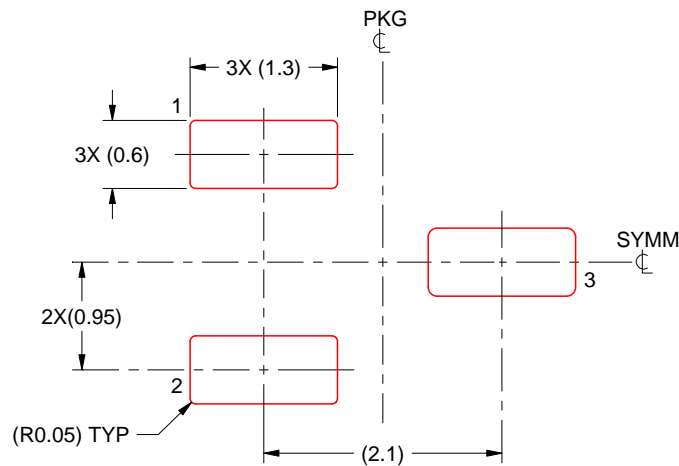

SOLDER PASTE EXAMPLE
BASED ON 0.125 THICK STENCIL
SCALE:15X

4214838/C 04/2017

NOTES: (continued)

6. Laser cutting apertures with trapezoidal walls and rounded corners may offer better paste release. IPC-7525 may have alternate design recommendations.
7. Board assembly site may have different recommendations for stencil design.

GENERIC PACKAGE VIEW

DQN 4

X2SON - 0.4 mm max height

PLASTIC SMALL OUTLINE - NO LEAD



Images above are just a representation of the package family, actual package may vary.
Refer to the product data sheet for package details.

4210367/F

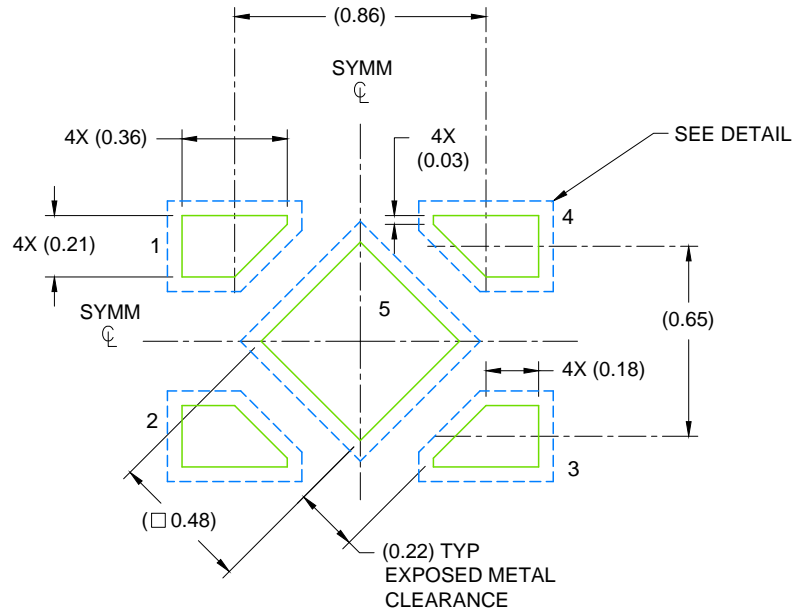

LAND PATTERN EXAMPLE
SCALE: 40X

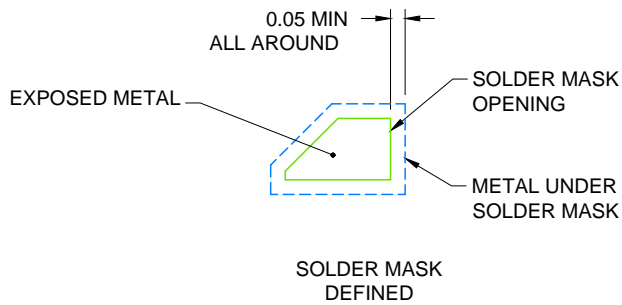

SOLDER MASK DETAIL

4215302/E 12/2016

NOTES: (continued)

7. This package is designed to be soldered to a thermal pad on the board. For more information, see Texas Instruments literature number SLUA271 (www.ti.com/lit/sluea271).
8. If any vias are implemented, it is recommended that vias under paste be filled, plugged or tented.

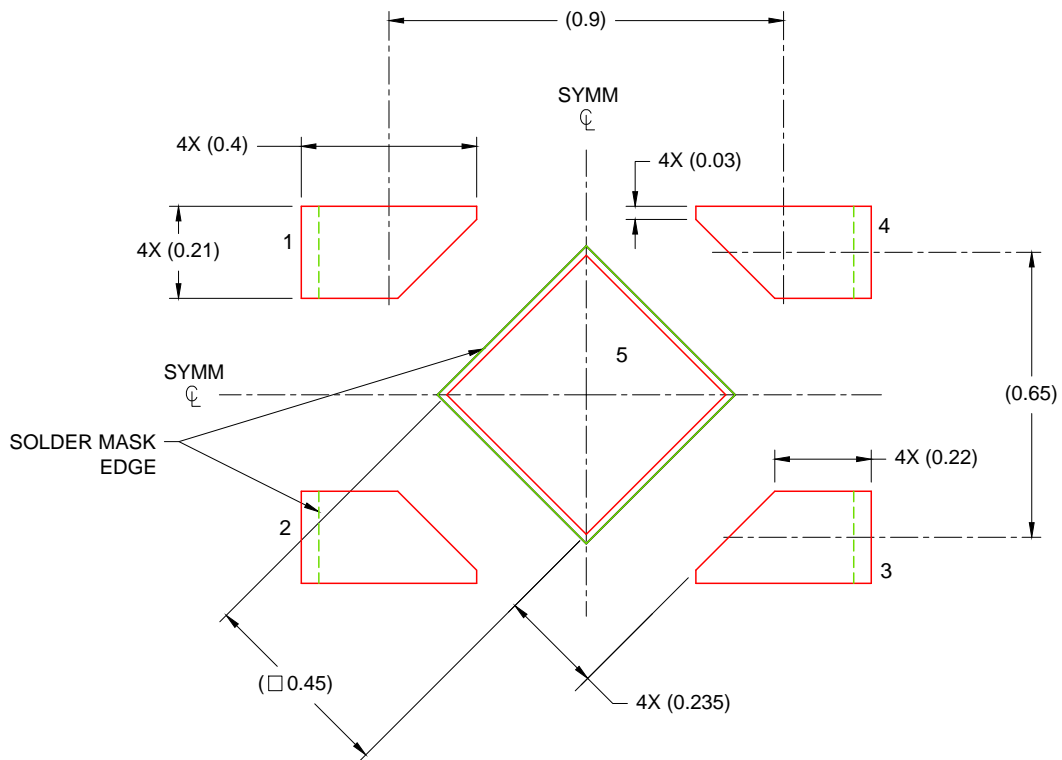

SOLDER PASTE EXAMPLE
 BASED ON 0.075 - 0.1mm THICK STENCIL
 EXPOSED PAD
 88% PRINTED SOLDER COVERAGE BY AREA
 SCALE: 60X

4215302/E 12/2016

NOTES: (continued)

- 9. Laser cutting apertures with trapezoidal walls and rounded corners may offer better paste release. IPC-7525 may have alternate design recommendations.

IMPORTANT NOTICE AND DISCLAIMER

TI PROVIDES TECHNICAL AND RELIABILITY DATA (INCLUDING DATASHEETS), DESIGN RESOURCES (INCLUDING REFERENCE DESIGNS), APPLICATION OR OTHER DESIGN ADVICE, WEB TOOLS, SAFETY INFORMATION, AND OTHER RESOURCES "AS IS" AND WITH ALL FAULTS, AND DISCLAIMS ALL WARRANTIES, EXPRESS AND IMPLIED, INCLUDING WITHOUT LIMITATION ANY IMPLIED WARRANTIES OF MERCHANTABILITY, FITNESS FOR A PARTICULAR PURPOSE OR NON-INFRINGEMENT OF THIRD PARTY INTELLECTUAL PROPERTY RIGHTS.

These resources are intended for skilled developers designing with TI products. You are solely responsible for (1) selecting the appropriate TI products for your application, (2) designing, validating and testing your application, and (3) ensuring your application meets applicable standards, and any other safety, security, or other requirements. These resources are subject to change without notice. TI grants you permission to use these resources only for development of an application that uses the TI products described in the resource. Other reproduction and display of these resources is prohibited. No license is granted to any other TI intellectual property right or to any third party intellectual property right. TI disclaims responsibility for, and you will fully indemnify TI and its representatives against, any claims, damages, costs, losses, and liabilities arising out of your use of these resources.

TI's products are provided subject to TI's Terms of Sale (<https://www.ti.com/legal/termsofsale.html>) or other applicable terms available either on [ti.com](https://www.ti.com) or provided in conjunction with such TI products. TI's provision of these resources does not expand or otherwise alter TI's applicable warranties or warranty disclaimers for TI products.

Mailing Address: Texas Instruments, Post Office Box 655303, Dallas, Texas 75265
Copyright © 2021, Texas Instruments Incorporated