

MOSFET – Single, N-Channel, POWERTRENCH®

30 V, 6.5 A, 23 mΩ

FDN537N

General Description

This N-Channel MOSFET is produced using onsemi advanced POWERTRENCH® process that has been optimized for $r_{DS(on)}$, switching performance and ruggedness.

Features

- Max $r_{DS(on)}$ = 23 mΩ @ $V_{GS} = 10\text{ V}$, $I_D = 6.5\text{ A}$
- Max $r_{DS(on)}$ = 36 mΩ @ $V_{GS} = 4.5\text{ V}$, $I_D = 6.0\text{ A}$
- High Performance Trench Technology for Extremely Low $r_{DS(on)}$
- High Power and Current Handling Capability in a Widely Used Surface Mount Package
- Fast Switching Speed
- 100% UIL Tested
- This Device is Pb-Free and is RoHS Compliant

Application

- Primary DC-DC Switch

ABSOLUTE MAXIMUM RATINGS ($T_A = 25^\circ\text{C}$, unless otherwise noted)

Symbol	Parameter	Value	Unit
V_{DS}	Drain to Source Voltage	30	V
V_{GS}	Gate to Source Voltage (Note 3)	±20	V
I_D	Drain Current	Continuous (Package limited) $T_C = 25^\circ\text{C}$	8.0
		Continuous (Note 1a) $T_A = 25^\circ\text{C}$	6.5
		Pulsed	25
P_D	Power Dissipation	(Note 1a)	1.5
		(Note 1b)	0.6
T_J, T_{STG}	Operating and Storage Junction Temperature Range	-55 to 150	$^\circ\text{C}$

Stresses exceeding those listed in the Maximum Ratings table may damage the device. If any of these limits are exceeded, device functionality should not be assumed, damage may occur and reliability may be affected.

THERMAL CHARACTERISTICS ($T_A = 25^\circ\text{C}$, unless otherwise noted)

Symbol	Parameter	Max	Unit
$R_{\theta JA}$	Thermal Resistance, Junction-to-Ambient (Note 1a)	80	$^\circ\text{C}/\text{W}$
	Thermal Resistance, Junction-to-Ambient (Note 1b)	180	

V_{DS}	$r_{DS(on)}$ MAX	I_D MAX
30 V	23 mΩ @ 10 V	6.5 A
	36 mΩ @ 4.5 V	

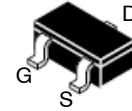

SOT-23/SUPERSOT™ -23, 3 LEAD, 1.4x2.9 CASE 527AG

MARKING DIAGRAM

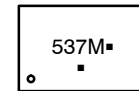

- 537 = Specific Device Code
- M = Month Code
- = Pb-Free Package

(Note: Microdot may be in either location)

PIN ASSIGNMENT

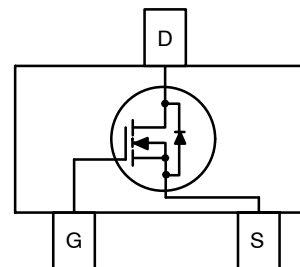

ORDERING INFORMATION

See detailed ordering and shipping information on page 5 of this data sheet.

FDN537N

ELECTRICAL CHARACTERISTICS (T_J = 25°C unless otherwise noted)

Symbol	Parameter	Test Conditions	Min	Typ	Max	Unit
--------	-----------	-----------------	-----	-----	-----	------

OFF CHARACTERISTICS

BV _{DSS}	Drain to Source Breakdown Voltage	I _D = 250 μA, V _{GS} = 0 V	30	–	–	V
$\frac{\Delta BV_{DSS}}{\Delta T_J}$	Breakdown Voltage Temperature Coefficient	I _D = 250 μA, referenced to 25°C	–	18	–	mV/°C
I _{DSS}	Zero Gate Voltage Drain Current	V _{DS} = 24 V, V _{GS} = 0 V	–	–	1	μA
I _{GSS}	Gate to Source Leakage Current, Forward	V _{GS} = 20 V, V _{DS} = 0 V	–	–	100	nA

ON CHARACTERISTICS

V _{GS(th)}	Gate to Source Threshold Voltage	V _{GS} = V _{DS} , I _D = 250 μA	1.2	1.8	3.0	V
$\frac{\Delta V_{GS(th)}}{\Delta T_J}$	Gate to Source Threshold Voltage Temperature Coefficient	I _D = 250 μA, referenced to 25°C	–	–6	–	mV/°C
r _{DS(on)}	Static Drain to Source On Resistance	V _{GS} = 10 V, I _D = 6.5 A	–	19	23	mΩ
		V _{GS} = 4.5 V, I _D = 6.0 A	–	25	36	
		V _{GS} = 10 V, I _D = 6.5 A, T _J = 125°C	–	25	30	
g _{FS}	Forward Transconductance	V _{DD} = 5 V, I _D = 6.5 A	–	24	–	S

DYNAMIC CHARACTERISTICS

C _{iss}	Input Capacitance	V _{DS} = 15 V, V _{GS} = 0 V, f = 1 MHz	–	360	465	pF
C _{oss}	Output Capacitance		–	143	180	pF
C _{rss}	Reverse Transfer Capacitance		–	22	35	pF
R _g	Gate Resistance		–	1.0	–	Ω

SWITCHING CHARACTERISTICS

t _{d(on)}	Turn-On Delay Time	V _{DD} = 15 V, I _D = 6.5 A, V _{GS} = 10 V, R _{GEN} = 6 Ω	–	5	10	ns
t _r	Rise Time		–	1	10	ns
t _{d(off)}	Turn-Off Delay Time		–	11	19	ns
t _f	Fall Time		–	1	10	ns
Q _{g(TOT)}	Total Gate Charge	V _{GS} = 0 V to 10 V, V _{DD} = 15 V, I _D = 6.5 A	–	6.0	8.4	nC
		V _{GS} = 0 V to 4.5 V, V _{DD} = 15 V, I _D = 6.5 A	–	3.0	4.2	nC
Q _{gs}	Gate to Source Charge	V _{DD} = 15 V, I _D = 6.5 A	–	1.2	–	nC
Q _{gd}	Gate to Drain "Miller" Charge		–	1.1	–	nC

DRAIN-SOURCE DIODE CHARACTERISTICS

V _{SD}	Source to Drain Diode Forward Voltage	V _{GS} = 0 V, I _S = 6.5 A (Note 2)	–	0.86	1.2	V
t _{rr}	Reverse Recovery Time	I _F = 6.5 A, di/dt = 100 A/μs	–	14	22	ns
Q _{rr}	Reverse Recovery Charge		–	3	10	nC

Product parametric performance is indicated in the Electrical Characteristics for the listed test conditions, unless otherwise noted. Product performance may not be indicated by the Electrical Characteristics if operated under different conditions.

NOTES:

- R_{θJA} is the sum of the junction-to-case and case-to-ambient thermal resistance where the case thermal reference is defined as the solder mounting surface of the drain pins. R_{θJC} is guaranteed by design while R_{θCA} is determined by the user's board design.

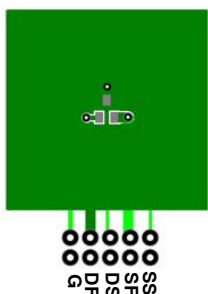

a) 80°C/W when mounted on a 1 in² pad of 2 oz copper



b) 180°C/W when mounted on a minimum pad

- Pulse Test: Pulse Width < 300 μs, Duty Cycle < 2.0%.
- As an N-ch device, the negative V_{GS} rating is for low duty cycle pulse occurrence only. No continuous rating is implied.

TYPICAL CHARACTERISTICS

($T_J = 25^\circ\text{C}$ unless otherwise noted)

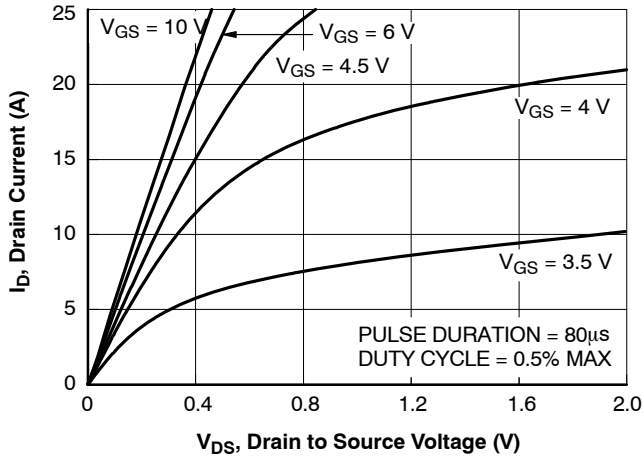

Figure 1. On Region Characteristics

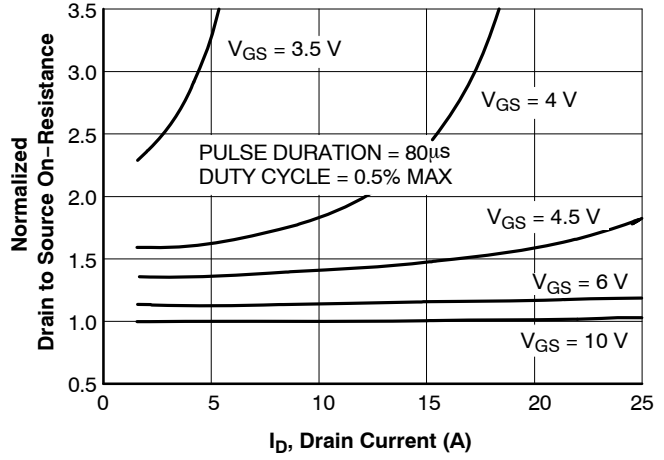

Figure 2. Normalized On-Resistance vs Drain Current and Gate Voltage

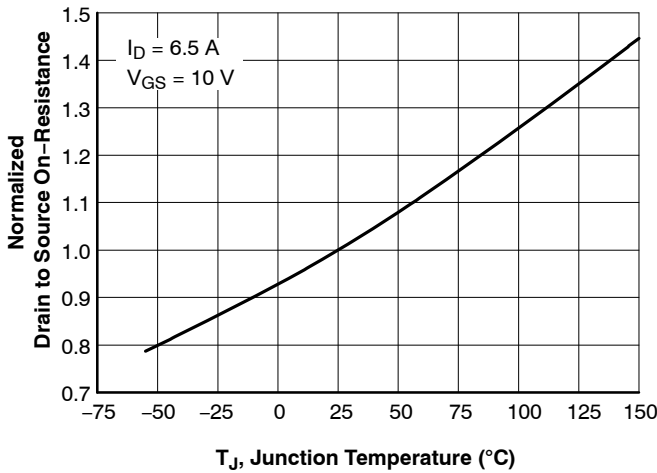

Figure 3. Normalized On-Resistance vs Junction Temperature

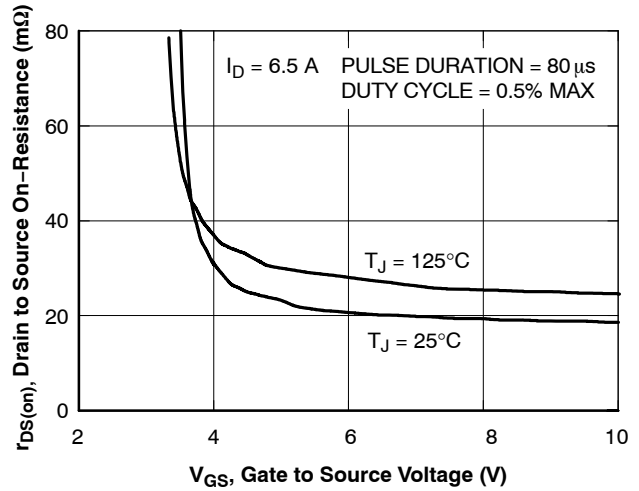

Figure 4. On-Resistance vs Gate to Source Voltage

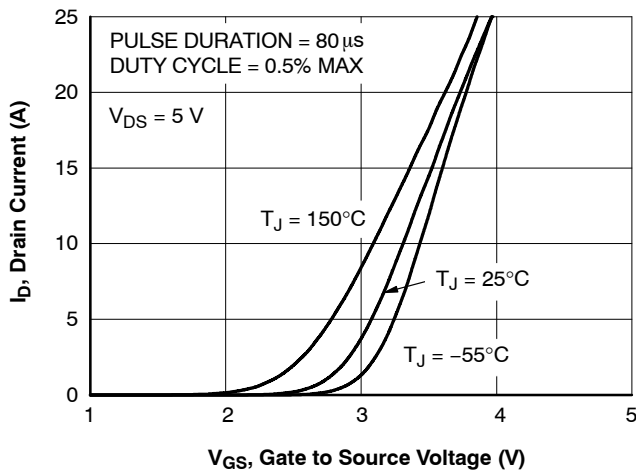

Figure 5. Transfer Characteristics

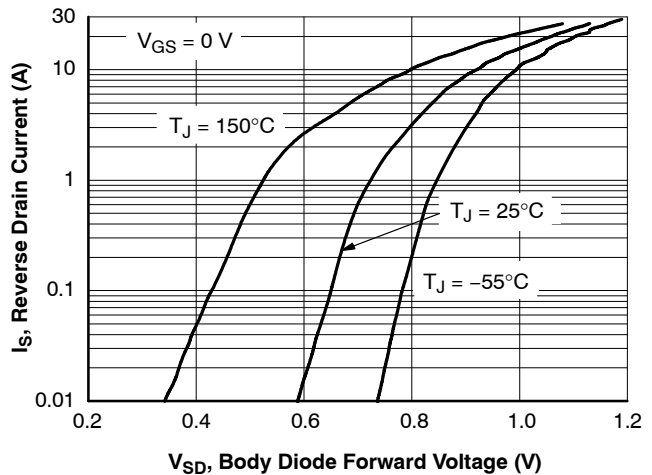

Figure 6. Source to Drain Diode Forward Voltage vs Source Current

FDN537N

TYPICAL CHARACTERISTICS (continued)

($T_J = 25^\circ\text{C}$ unless otherwise noted)

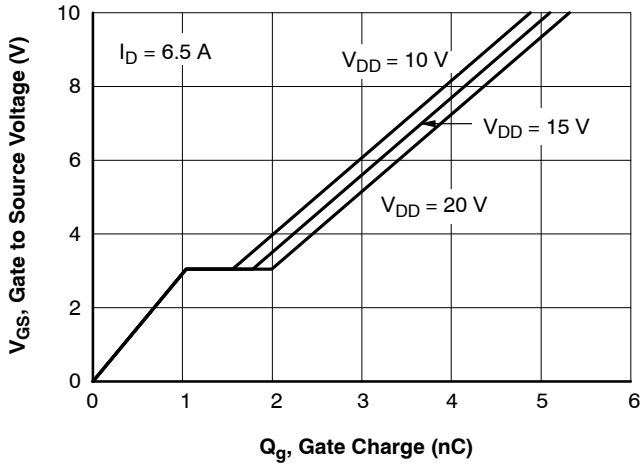

Figure 7. Gate Charge Characteristics

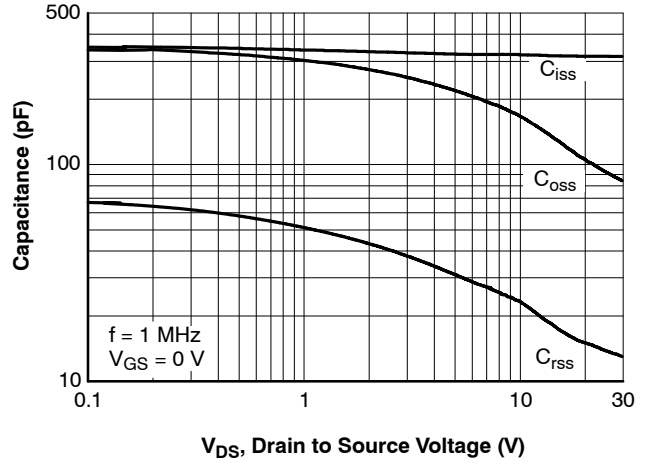

Figure 8. Capacitance vs Drain to Source Voltage

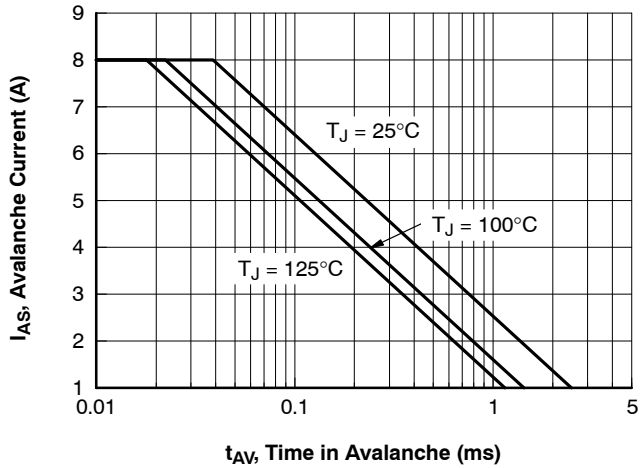

Figure 9. Unclamped Inductive Switching Capability

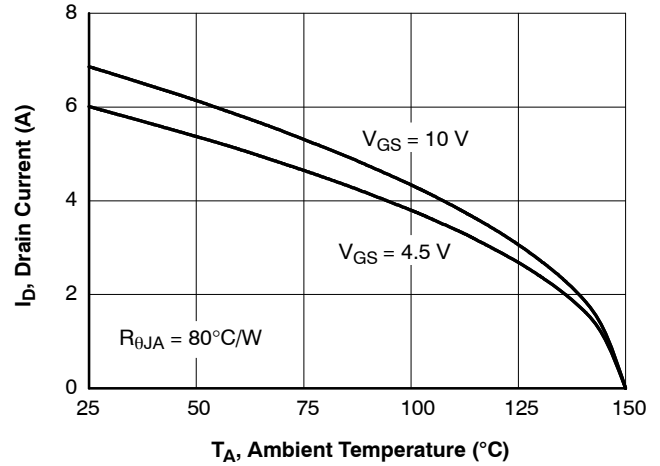

Figure 10. Maximum Continuous Drain Current vs Ambient Temperature

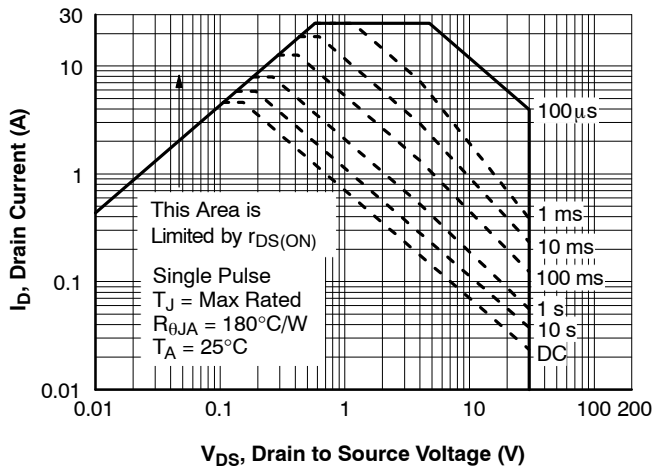

Figure 11. Forward Bias Safe Operating Area

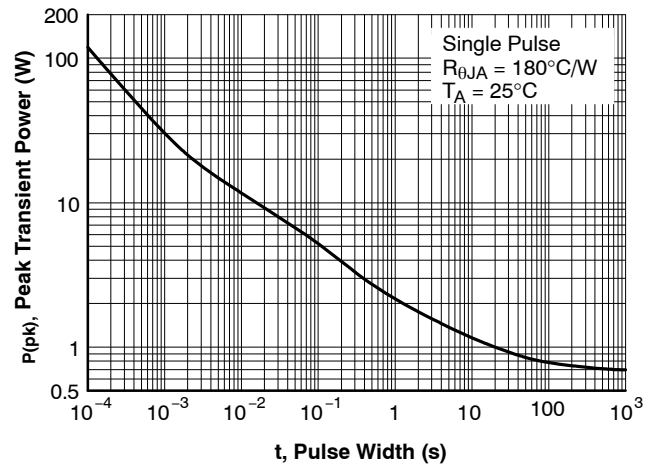

Figure 12. Single Pulse Maximum Power Dissipation

FDN537N

TYPICAL CHARACTERISTICS (continued)

($T_J = 25^\circ\text{C}$ unless otherwise noted)

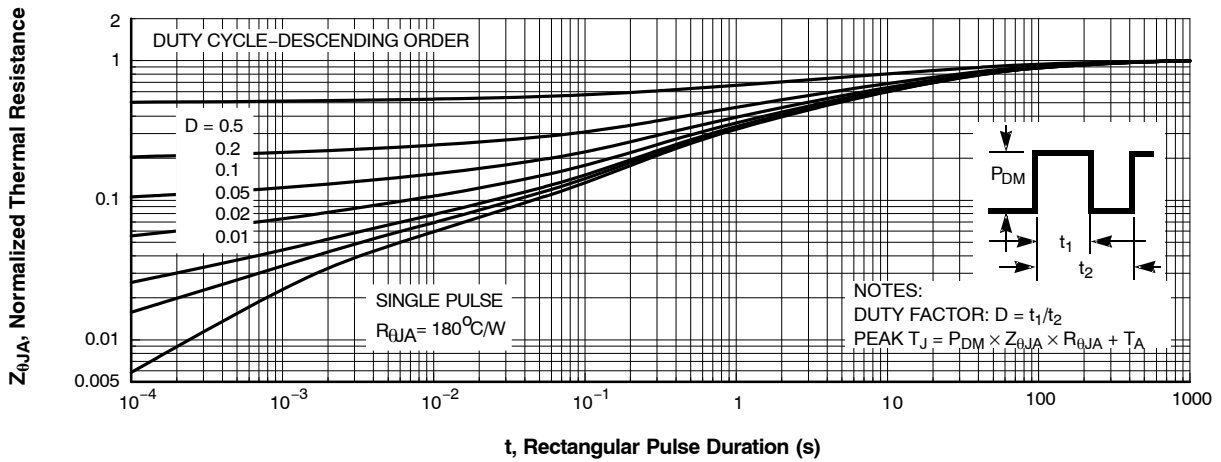

Figure 13. Junction-to-Ambient Transient Thermal Response Curve

PACKAGE MARKING AND ORDERING INFORMATION

Device	Device Marking	Package	Shipping [†]
FDN537N	537	SOT-23/SUPERSOT-23, 3 LEAD, 1.4x2.9 (Pb-Free, Halide Free)	3000 / Tape & Reel

[†]For information on tape and reel specifications, including part orientation and tape sizes, please refer to our Tape and Reel Packaging Specifications Brochure, [BRD8011/D](#).

POWERTRENCH is a registered trademark of Semiconductor Components Industries, LLC dba "onsemi" or its affiliates and/or subsidiaries in the United States and/or other countries.
 SUPERSOT is a trademark of Semiconductor Components Industries, LLC dba "onsemi" or its affiliates and/or subsidiaries in the United States and/or other countries.

MECHANICAL CASE OUTLINE

PACKAGE DIMENSIONS

ON Semiconductor®



SOT-23/SUPERSOT™ -23, 3 LEAD, 1.4x2.9

CASE 527AG
ISSUE A

DATE 09 DEC 2019

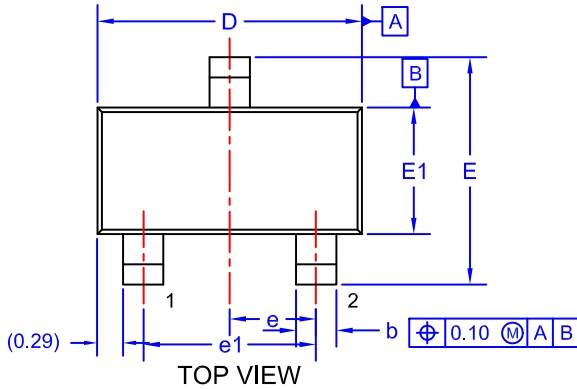

NOTES: UNLESS OTHERWISE SPECIFIED

1. DIMENSIONING AND TOLERANCING PER ASME Y14.5M, 2009.
2. ALL DIMENSIONS ARE IN MILLIMETERS.
3. DIMENSIONS ARE EXCLUSIVE OF BURRS, MOLD FLASH AND TIE BAR EXTRUSIONS.

DIM	MIN.	NOM.	MAX.
A	0.85	0.95	1.12
A1	0.00	0.05	0.10
b	0.370	0.435	0.508
c	0.085	0.150	0.180
D	2.80	2.92	3.04
E	2.31	2.51	2.71
E1	1.20	1.40	1.52
e	0.95 BSC		
e1	1.90 BSC		
L	0.33	0.38	0.43

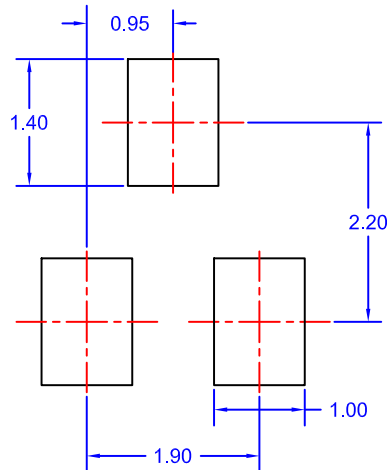
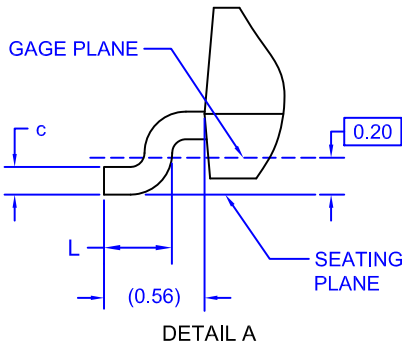
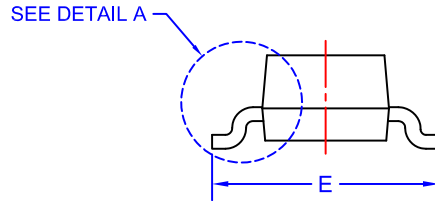
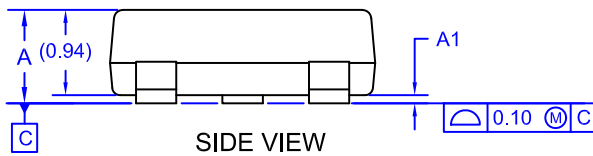

LAND PATTERN RECOMMENDATION*

*FOR ADDITIONAL INFORMATION ON OUR Pb-FREE STRATEGY AND SOLDERING DETAILS, PLEASE DOWNLOAD THE ON SEMICONDUCTOR SOLDERING AND MOUNTING TECHNIQUES REFERENCE MANUAL, SOLDERRM/D.

GENERIC MARKING DIAGRAM*

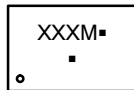

- XXX = Specific Device Code
- M = Month Code
- = Pb-Free Package

(Note: Microdot may be in either location)

*This information is generic. Please refer to device data sheet for actual part marking. Pb-Free indicator, "G" or microdot "▪", may or may not be present. Some products may not follow the Generic Marking.

DOCUMENT NUMBER:	98AON34319E	Electronic versions are uncontrolled except when accessed directly from the Document Repository. Printed versions are uncontrolled except when stamped "CONTROLLED COPY" in red.
DESCRIPTION:	SOT-23/SUPERSOT-23, 3 LEAD, 1.4X2.9	PAGE 1 OF 1

ON Semiconductor and are trademarks of Semiconductor Components Industries, LLC dba ON Semiconductor or its subsidiaries in the United States and/or other countries. ON Semiconductor reserves the right to make changes without further notice to any products herein. ON Semiconductor makes no warranty, representation or guarantee regarding the suitability of its products for any particular purpose, nor does ON Semiconductor assume any liability arising out of the application or use of any product or circuit, and specifically disclaims any and all liability, including without limitation special, consequential or incidental damages. ON Semiconductor does not convey any license under its patent rights nor the rights of others.

onsemi, **Onsemi**, and other names, marks, and brands are registered and/or common law trademarks of Semiconductor Components Industries, LLC dba "**onsemi**" or its affiliates and/or subsidiaries in the United States and/or other countries. **onsemi** owns the rights to a number of patents, trademarks, copyrights, trade secrets, and other intellectual property. A listing of **onsemi**'s product/patent coverage may be accessed at www.onsemi.com/site/pdf/Patent-Marking.pdf. **onsemi** reserves the right to make changes at any time to any products or information herein, without notice. The information herein is provided "as-is" and **onsemi** makes no warranty, representation or guarantee regarding the accuracy of the information, product features, availability, functionality, or suitability of its products for any particular purpose, nor does **onsemi** assume any liability arising out of the application or use of any product or circuit, and specifically disclaims any and all liability, including without limitation special, consequential or incidental damages. Buyer is responsible for its products and applications using **onsemi** products, including compliance with all laws, regulations and safety requirements or standards, regardless of any support or applications information provided by **onsemi**. "Typical" parameters which may be provided in **onsemi** data sheets and/or specifications can and do vary in different applications and actual performance may vary over time. All operating parameters, including "Typicals" must be validated for each customer application by customer's technical experts. **onsemi** does not convey any license under any of its intellectual property rights nor the rights of others. **onsemi** products are not designed, intended, or authorized for use as a critical component in life support systems or any FDA Class 3 medical devices or medical devices with a same or similar classification in a foreign jurisdiction or any devices intended for implantation in the human body. Should Buyer purchase or use **onsemi** products for any such unintended or unauthorized application, Buyer shall indemnify and hold **onsemi** and its officers, employees, subsidiaries, affiliates, and distributors harmless against all claims, costs, damages, and expenses, and reasonable attorney fees arising out of, directly or indirectly, any claim of personal injury or death associated with such unintended or unauthorized use, even if such claim alleges that **onsemi** was negligent regarding the design or manufacture of the part. **onsemi** is an Equal Opportunity/Affirmative Action Employer. This literature is subject to all applicable copyright laws and is not for resale in any manner.

ADDITIONAL INFORMATION

TECHNICAL PUBLICATIONS:

Technical Library: www.onsemi.com/design/resources/technical-documentation
onsemi Website: www.onsemi.com

ONLINE SUPPORT: www.onsemi.com/support

For additional information, please contact your local Sales Representative at www.onsemi.com/support/sales