

THIS DRAWING IS UNPUBLISHED. RELEASED FOR PUBLICATION APR ,2008.  
 © COPYRIGHT 2008 BY TYCO ELECTRONICS CORPORATION. ALL RIGHTS RESERVED.

LOC		DIST		REVISIONS		
J				変更		
P	LTR	DESCRIPTION		DATE	DWN	APVD
	A1	RELEASED ECR-18-019397		29SEP2019	J.J	W.H

引き出し方向  
USER DIRECTION OF FEED

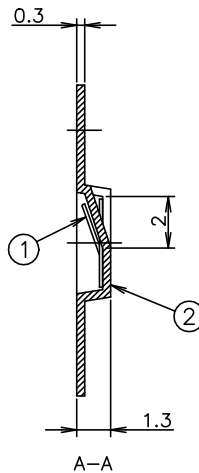
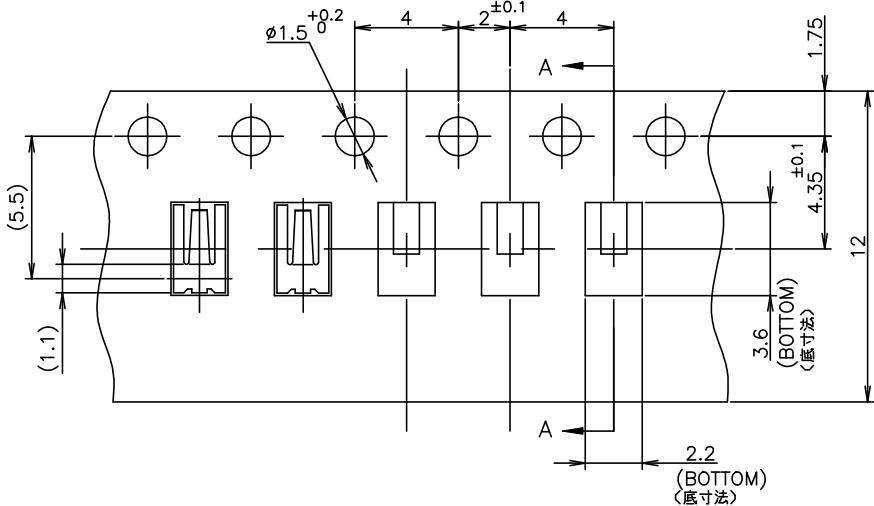

- 1 GENERAL TOLERANCE:  $\pm 0.3$
- 2 PACKING STYLE: 10000PCS/REEL
- 3 MATERIAL:  
SHIELD FINGER: COPPER ALLOY (NICKEL-PLATING)  
(Au PL. 0.00005 MIN.)  
(SOLDER-PLATING ON THE BOTTOM PLANE ONLY)

- CARRIER TAPE: ACRYLIC FILM
- TOP TAPE: PET FILM
- REEL: PLASTIC
- 4 TAPES DIMENSION

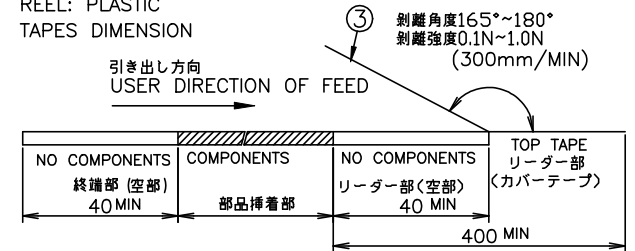

- 5 REEL DIMENSION: REFERENCE ONLY

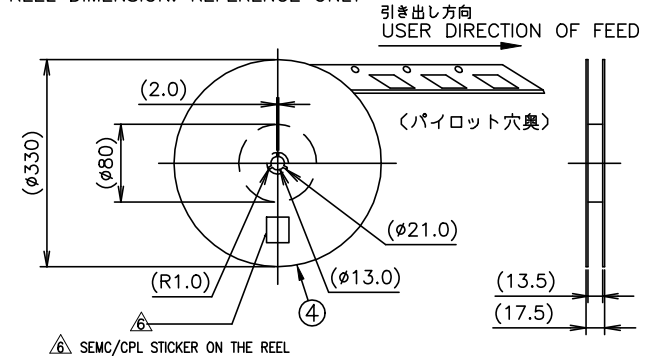

シールドフィンガー0820  
SHIELD FINGER 0820  
SCALE 10:1

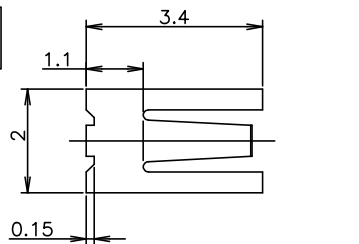

RECOMMENDED FOOT PRINT  
REFERENCE ONLY  
(GENERAL TOLERANCE  $\pm 0.1$ )  
参考パッド寸法 (公差 $\pm 0.1$ )

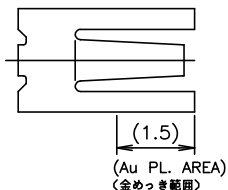
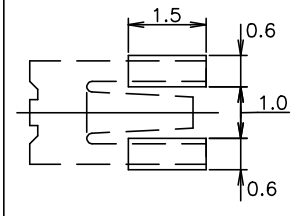

2040852-1	④	REEL	リール	1
	③	COVER TAPE	カバーテープ	1
	②	EMBOSS CARRIER TAPE	エンボスキャリアテープ	10000 POKETS (COMPONENTS)
	①	SHIELD FINGER 0820	シールドフィンガー0820	10000 PCS
PACKING CAT.NO.	NO.	NAME	名称	QUANTITY

THIS DRAWING IS A CONTROLLED DOCUMENT.		DWN	16JUL2008	Tyco Electronics Corporation	
		CHK	16JUL2008	Kawasaki, Japan	
		APVD	16JUL2008	SHIELD FINGER 0820	
DIMENSIONS: 単位: 特 mm		TOLERANCES UNLESS OTHERWISE SPECIFIED: 一般公差		NAME 名称	
0 PLC $\pm$		1 PLC $\pm$ SEE NOTE		SIZE	
2 PLC $\pm$		3 PLC $\pm$		CAGE CODE	
3 PLC $\pm$		4 PLC $\pm$		DRAWING NO 番号	
ANGLES $\pm$		FINISH 仕上		RESTRICTED TO	
MATERIAL 材料		WEIGHT		A300779	
		CUSTOMER DRAWING		SCALE 尺度 5:1	
				SHEET 1 of 1	
				REV A1	