

# PZTA92T1

Preferred Devices

## High Voltage Transistor

### PNP Silicon

#### Features

- Pb-Free Package is Available

#### MAXIMUM RATINGS ( $T_C = 25^\circ\text{C}$ unless otherwise noted)

Rating	Symbol	Value	Unit
Collector-Emitter Voltage	$V_{CEO}$	-300	Vdc
Collector-Base Voltage	$V_{CBO}$	-300	Vdc
Emitter-Base Voltage	$V_{EBO}$	-5.0	Vdc
Collector Current	$I_C$	-50	mAdc
Total Power Dissipation up to @ $T_A = 25^\circ\text{C}$ (Note 1)	$P_D$	1.5	W
Storage Temperature Range	$T_{stg}$	-65 to 150	$^\circ\text{C}$
Junction Temperature	$T_J$	150	$^\circ\text{C}$

#### THERMAL CHARACTERISTICS

Characteristic	Symbol	Max	Unit
Thermal Resistance, Junction-to-Ambient (Note 1)	$R_{\theta JA}$	83.3	$^\circ\text{C}/\text{W}$

Stresses exceeding Maximum Ratings may damage the device. Maximum Ratings are stress ratings only. Functional operation above the Recommended Operating Conditions is not implied. Extended exposure to stresses above the Recommended Operating Conditions may affect device reliability.

- Device mounted on a FR-4 glass epoxy printed circuit board  
1.575 in x 1.575 in x 0.0625 in; mounting pad for the collector lead = 0.93 sq in.



ON Semiconductor®

<http://onsemi.com>

### SOT-223 PACKAGE PNP SILICON HIGH VOLTAGE TRANSISTOR SURFACE MOUNT

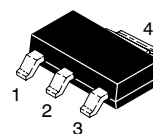
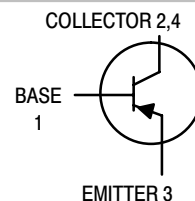

SOT-223  
CASE 318E-04  
STYLE 1

#### MARKING DIAGRAM

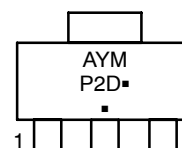

P2D = Specific Device Code  
A = Assembly Location  
Y = Year  
M = Date Code  
▪ = Pb-Free Package

(Note: Microdot may be in either location)

#### ORDERING INFORMATION

See detailed ordering and shipping information in the package dimensions section on page 3 of this data sheet.

Preferred devices are recommended choices for future use and best overall value.

# PZTA92T1

## ELECTRICAL CHARACTERISTICS ( $T_A = 25^\circ\text{C}$ unless otherwise noted)

Characteristics	Symbol	Min	Max	Unit
<b>OFF CHARACTERISTICS</b>				
Collector-Emitter Breakdown Voltage (Note 2) ( $I_C = -1.0\text{ mA}$ , $I_B = 0$ )	$V_{(BR)CEO}$	-300	—	Vdc
Collector-Base Breakdown Voltage ( $I_C = -100\text{ }\mu\text{A}$ , $I_E = 0$ )	$V_{(BR)CBO}$	-300	—	Vdc
Emitter-Base Breakdown Voltage ( $I_E = -100\text{ }\mu\text{A}$ , $I_C = 0$ )	$V_{(BR)EBO}$	-5.0	—	Vdc
Collector-Base Cutoff Current ( $V_{CB} = -200\text{ Vdc}$ , $I_E = 0$ )	$I_{CBO}$	—	-0.25	$\mu\text{A}$
Emitter-Base Cutoff Current ( $V_{BE} = -3.0\text{ Vdc}$ , $I_C = 0$ )	$I_{EBO}$	—	-0.1	$\mu\text{A}$
<b>ON CHARACTERISTICS</b>				
DC Current Gain ( $I_C = -1.0\text{ mA}$ , $V_{CE} = -10\text{ Vdc}$ ) ( $I_C = -10\text{ mA}$ , $V_{CE} = -10\text{ Vdc}$ ) ( $I_C = -30\text{ mA}$ , $V_{CE} = -10\text{ Vdc}$ )	$h_{FE}$	25 40 40	— — —	—
Saturation Voltages ( $I_C = -20\text{ mA}$ , $I_B = -2.0\text{ mA}$ ) ( $I_C = -20\text{ mA}$ , $I_B = -2.0\text{ mA}$ )	$V_{CE(sat)}$ $V_{BE(sat)}$	— —	-0.5 -0.9	Vdc
<b>DYNAMIC CHARACTERISTICS</b>				
Collector-Base Capacitance @ $f = 1.0\text{ MHz}$ ( $V_{CB} = -20\text{ Vdc}$ , $I_E = 0$ )	$C_{cb}$	—	6.0	pF
Current-Gain — Bandwidth Product ( $I_C = -10\text{ mA}$ , $V_{CE} = -20\text{ Vdc}$ , $f = 100\text{ MHz}$ )	$f_T$	50	—	MHz

2. Pulse Test Conditions,  $t_p = 300\text{ }\mu\text{s}$ ,  $\delta = 0.02$ .

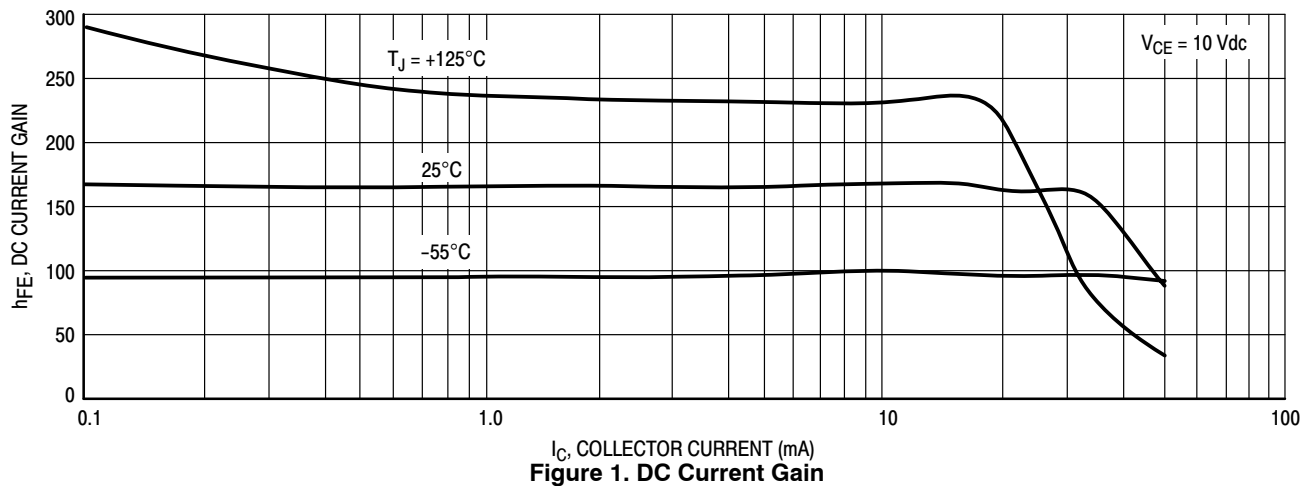

# PZTA92T1

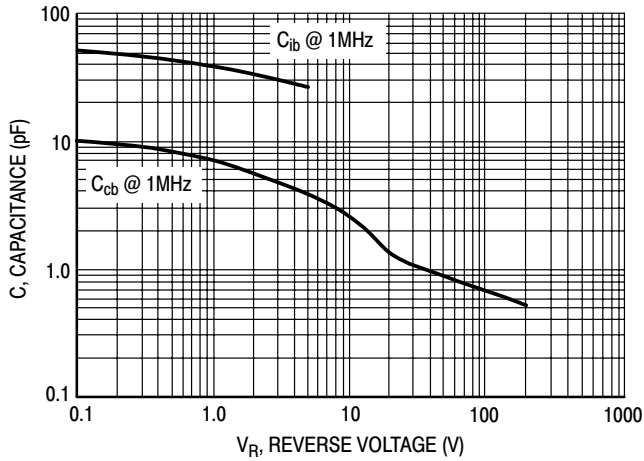

Figure 2. Capacitance

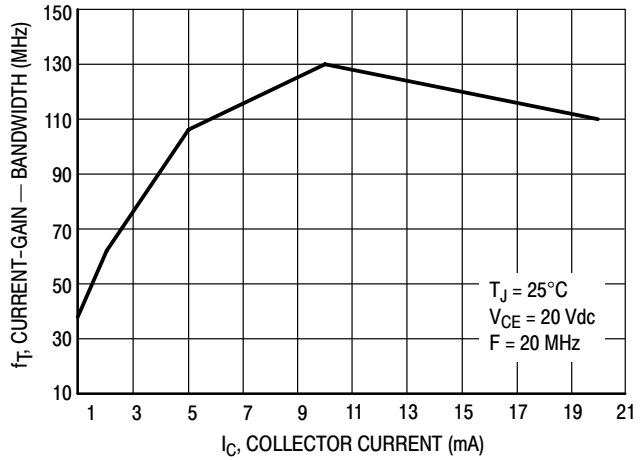

Figure 3. Current-Gain — Bandwidth

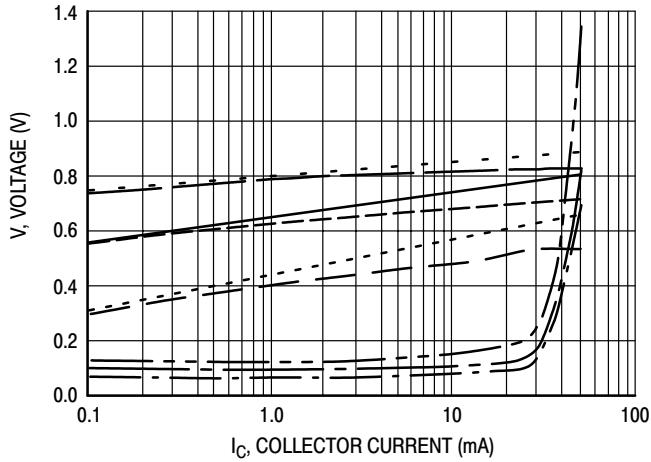

Figure 4. "ON" Voltages

- V<sub>CE(sat)</sub> @ 25°C, I<sub>C</sub>/I<sub>B</sub> = 10
- - - V<sub>CE(sat)</sub> @ 125°C, I<sub>C</sub>/I<sub>B</sub> = 10
- V<sub>CE(sat)</sub> @ -55°C, I<sub>C</sub>/I<sub>B</sub> = 10
- V<sub>BE(sat)</sub> @ 25°C, I<sub>C</sub>/I<sub>B</sub> = 10
- - - V<sub>BE(sat)</sub> @ 125°C, I<sub>C</sub>/I<sub>B</sub> = 10
- - - V<sub>BE(sat)</sub> @ -55°C, I<sub>C</sub>/I<sub>B</sub> = 10
- V<sub>BE(on)</sub> @ 25°C, V<sub>CE</sub> = 10 V
- - - V<sub>BE(on)</sub> @ 125°C, V<sub>CE</sub> = 10 V
- - - V<sub>BE(on)</sub> @ -55°C, V<sub>CE</sub> = 10 V

## ORDERING INFORMATION

Device	Package	Shipping <sup>†</sup>
PZTA92T1	SOT-223	1000 / Tape & Reel
PZTA92T1G	SOT-223 (Pb-Free)	1000 / Tape & Reel

<sup>†</sup>For information on tape and reel specifications, including part orientation and tape sizes, please refer to our Tape and Reel Packaging Specifications Brochure, BRD8011/D.

# PZTA92T1

## PACKAGE DIMENSIONS

SOT-223 (TO-261)  
CASE 318E-04  
ISSUE L

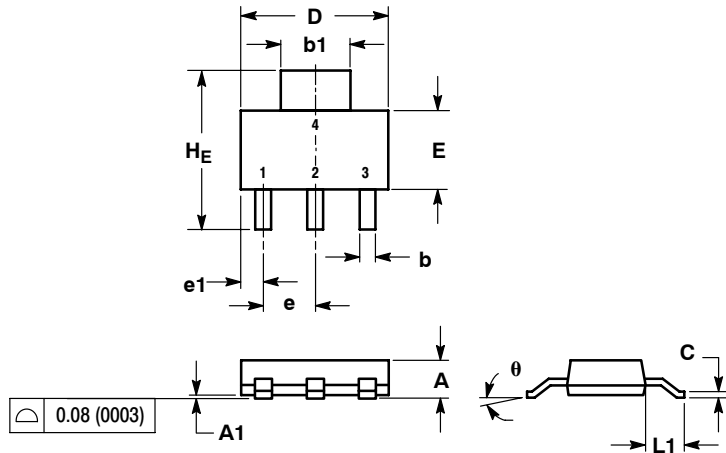

NOTES:

1. DIMENSIONING AND TOLERANCING PER ANSI Y14.5M, 1982.
2. CONTROLLING DIMENSION: INCH.

DIM	MILLIMETERS			INCHES		
	MIN	NOM	MAX	MIN	NOM	MAX
A	1.50	1.63	1.75	0.060	0.064	0.068
A1	0.02	0.06	0.10	0.001	0.002	0.004
b	0.60	0.75	0.89	0.024	0.030	0.035
b1	2.90	3.06	3.20	0.115	0.121	0.126
c	0.24	0.29	0.35	0.009	0.012	0.014
D	6.30	6.50	6.70	0.249	0.256	0.263
E	3.30	3.50	3.70	0.130	0.138	0.145
e	2.20	2.30	2.40	0.087	0.091	0.094
e1	0.85	0.94	1.05	0.033	0.037	0.041
L1	1.50	1.75	2.00	0.060	0.069	0.078
H	6.70	7.00	7.30	0.264	0.276	0.287
θ	0°	-	10°	0°	-	10°

STYLE 1:

- PIN 1. BASE
- COLLECTOR
- EMITTER
- COLLECTOR

### SOLDERING FOOTPRINT\*

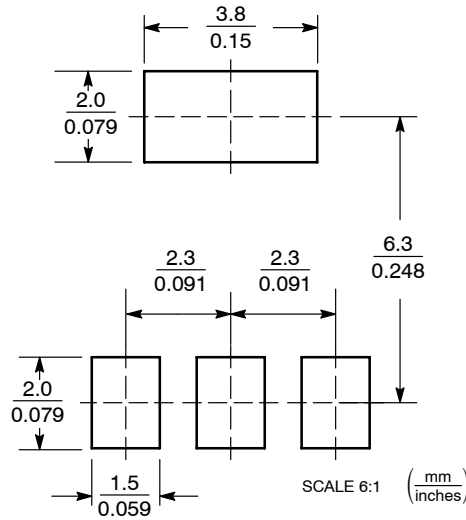

\*For additional information on our Pb-Free strategy and soldering details, please download the ON Semiconductor Soldering and Mounting Techniques Reference Manual, SOLDERRM/D.

ON Semiconductor and are registered trademarks of Semiconductor Components Industries, LLC (SCILLC). SCILLC reserves the right to make changes without further notice to any products herein. SCILLC makes no warranty, representation or guarantee regarding the suitability of its products for any particular purpose, nor does SCILLC assume any liability arising out of the application or use of any product or circuit, and specifically disclaims any and all liability, including without limitation special, consequential or incidental damages. "Typical" parameters which may be provided in SCILLC data sheets and/or specifications can and do vary in different applications and actual performance may vary over time. All operating parameters, including "Typicals" must be validated for each customer application by customer's technical experts. SCILLC does not convey any license under its patent rights nor the rights of others. SCILLC products are not designed, intended, or authorized for use as components in systems intended for surgical implant into the body, or other applications intended to support or sustain life, or for any other application in which the failure of the SCILLC product could create a situation where personal injury or death may occur. Should Buyer purchase or use SCILLC products for any such unintended or unauthorized application, Buyer shall indemnify and hold SCILLC and its officers, employees, subsidiaries, affiliates, and distributors harmless against all claims, costs, damages, and expenses, and reasonable attorney fees arising out of, directly or indirectly, any claim of personal injury or death associated with such unintended or unauthorized use, even if such claim alleges that SCILLC was negligent regarding the design or manufacture of the part. SCILLC is an Equal Opportunity/Affirmative Action Employer. This literature is subject to all applicable copyright laws and is not for resale in any manner.

### PUBLICATION ORDERING INFORMATION

LITERATURE FULFILLMENT:  
Literature Distribution Center for ON Semiconductor  
P.O. Box 5163, Denver, Colorado 80217 USA  
Phone: 303-675-2175 or 800-344-3860 Toll Free USA/Canada  
Fax: 303-675-2176 or 800-344-3867 Toll Free USA/Canada  
Email: orderlit@onsemi.com

N. American Technical Support: 800-282-9855 Toll Free  
USA/Canada  
Europe, Middle East and Africa Technical Support:  
Phone: 421 33 790 2910  
Japan Customer Focus Center  
Phone: 81-3-5773-3850

ON Semiconductor Website: [www.onsemi.com](http://www.onsemi.com)  
Order Literature: <http://www.onsemi.com/orderlit>  
For additional information, please contact your local Sales Representative