

1MHz, PWM Controlled, Step-Up DC/DC Converter, Ceramic Capacitor Compatible

■ GENERAL DESCRIPTION

The XC9119 series is 1MHz, PWM controlled step-up DC/DC converter, designed to allow the use of ceramic capacitors. With a built-in 2.0Ω switching transistor, the XC9119 series can easily provide a step-up operation by using only a coil, a diode, a capacitor, and a resistor, connected externally.

Since output voltage up to 19.5V (Maximum Lx operating voltage: 20V) can be derived with reference voltage supply of 1.0V ($\pm 2.0\%$) and external components, the series can easily supply high voltage for various general-purpose power supplies, LCD panels and organic EL displays.

With a high switching frequency of 1.0MHz, a low profile and small board area solution can be achieved using a chip coil and an ultra small ceramic output capacitor.

With the current limit function (400mA (TYP.): $V_{DD}=3.6V$), a peak current, which flows through built-in driver transistors can be limited. Soft-start time can be adjusted by external resistors and capacitors. The stand-by function enables the output to be turned off (CE 'L'), that is, the supply current will be less than $1.0\mu A$.

■ APPLICATIONS

- Organic electroluminescence display (OLED)
- Power supplies for LCDs
- Multi-function power supplies

■ FEATURES

Operating Voltage Range	: 2.5V ~ 6.0V
Output Voltage Range	: Up to 19.5V externally set-up : Reference voltage 1.0V $\pm 2.0\%$
Oscillation Frequency	: 1.0MHz $\pm 20\%$
ON Resistance	: 2.0Ω ($V_{DD}=3.6V$, $V_{DS}=0.4V$)
Efficiency	: 86% ($V_{OUT}=15V$, $V_{DD}=3.6V$, $I_{OUT}=10mA$)
Control	: PWM control
Stand-by function	: $I_{STB}=1.0\mu A$ (MAX.)
Load Capacitor	: Low ESR ceramic capacitor
Ultra Small Packages	: SOT-25, USP-6C
Lx Limit Current	: 400mA ($V_{DD}=3.6V$)

■ TYPICAL APPLICATION CIRCUIT

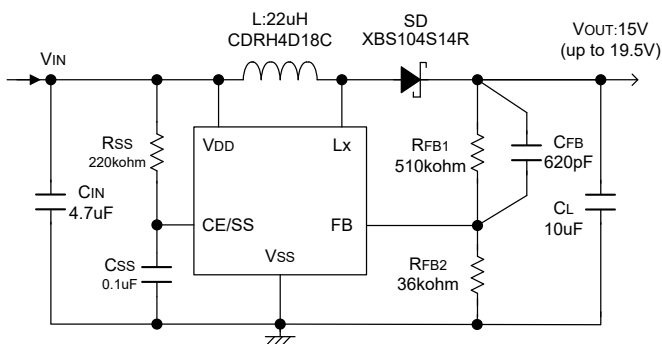

■ TYPICAL PERFORMANCE CHARACTERISTICS

○ Efficiency vs. Output Current

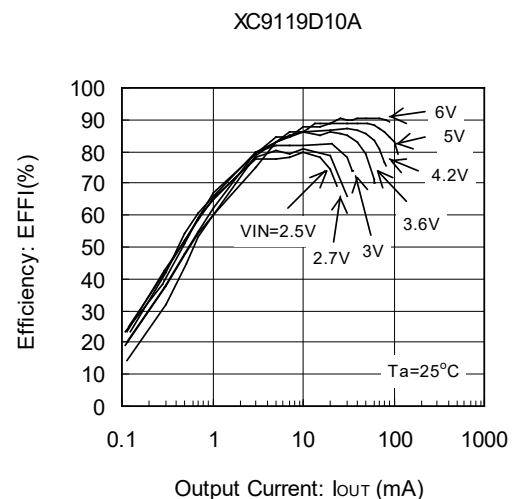

■ PIN CONFIGURATION

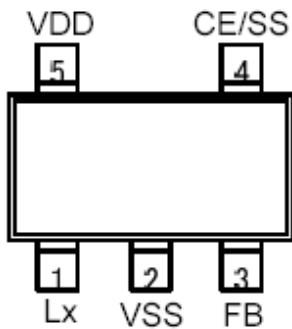

SOT-25
(TOP VIEW)

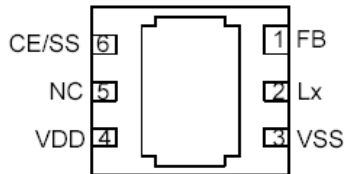

USP-6C
(BOTTOM VIEW)

*The dissipation pad for the USP-6C package should be solder-plated in recommended mount pattern and metal masking so as to enhance mounting strength and heat resistance. If the pad needs to be connected to other pins, it should be connected to the VSS pin.

■ PIN ASSIGNMENT

PIN NUMBER		PIN NAME	FUNCTION
SOT-25	USP-6C		
1	2	Lx	Switch
2	3	Vss	Ground
3	1	FB	Voltage Feedback
4	6	CE/SS	Chip Enable/ Soft Start
5	4	VDD	Power Input
-	5	NC	No Connection

■ CE PIN FUNCTION

CE/SS PIN	OPERATIONAL STATE
H	Operation
L	Shut-down

■ PRODUCT CLASSIFICATION

● Ordering Information

XC9119D①②③④⑤-⑥^(*)

DESIGNATOR	ITEM	SYMBOL	DESCRIPTION
①②	Reference Voltage	10	FB voltage
③	Oscillation Frequency	A	1MHz
④⑤-⑥	Packages (Order Unit)	MR-G	SOT-25 (3,000pcs/Reel)
		ER-G	USP-6C (3,000pcs/Reel)

(*) The "-G" suffix denotes Halogen and Antimony free as well as being fully EU RoHS compliant.

■ BLOCK DIAGRAM

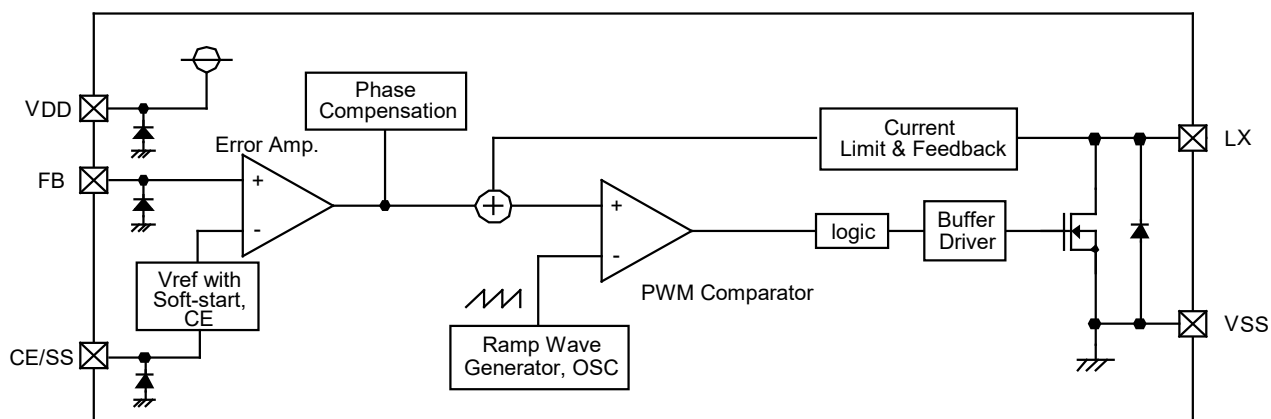

■ ABSOLUTE MAXIMUM RATINGS

			Ta=25°C
PARAMETER	SYMBOL	RATINGS	UNITS
VDD Pin Voltage	VDD	Vss - 0.3 ~ 7.0	V
Lx Pin Voltage	VLx	Vss - 0.3 ~ 22.0	V
FB Pin Voltage	VFB	Vss - 0.3 ~ 7.0	V
CE Pin Voltage	VCE	Vss - 0.3 ~ 7.0	V
Lx Pin Current	ILx	1000	mA
Power Dissipation	SOT-25	250	mW
		760 (JE5D51-7 board) ^(*1)	
	USP-6C	120	
	1250 (JE5D51-7 board) ^(*1)		
Operating Ambient Temperature	Topr	-40 ~ 85	°C
Storage Temperature	Tstg	-55 ~ 125	°C

(*1) The power dissipation figure shown is PCB mounted and is for reference only.
Please refer to PACKAGING INFORMATION for the mounting condition.

ELECTRICAL CHARACTERISTICS

Ta = 25°C

PARAMETER	SYMBOL	CONDITIONS	MIN.	TYP.	MAX.	UNIT	CIRCUIT
FB Voltage	V _{FB}	-	0.980	1.000	1.020	V	①
Line Regulation	$\frac{\Delta V_{FB}}{\Delta V_{IN}} \cdot V_{FB}$	2.5 ≤ V _{DD} ≤ 6.0V	-	0.05	0.20	%/V	①
Supply Voltage	V _{DD}	-	2.5	-	6.0	V	①
Operation Start-up Voltage	V _{ST1}	I _{OUT} =0mA	-	-	2.5	V	②
Supply Current 1	I _{DD1}	V _{IN} =V _{CE} =3.0V, V _{FB} =0V, V _{pull} =5.0V R _{pull} =100Ω	-	450	700	μA	②
Supply Current 2	I _{DD2}	V _{FB} =2.0V	-	55	110	μA	②
Stand-by Current	I _{STB}	V _{CE} =0V	-	-	1.0	μA	③
Oscillation Frequency	f _{OSC}	Same as I _{DD1}	0.8	1.0	1.2	MHz	②
Maximum Duty Ratio	MAXDTY	Same as I _{DD1}	86	92	98	%	②
Efficiency (*1)	EFFI	V _{IN} =V _{DD} =3.6V, V _{OUT} =15V, I _{OUT} =10mA	-	86	-	%	①
Current Limit	I _{LIM}	V _{DD} =3.6V	310	400	750	mA	④
Lx Operating Voltage Range	V _{Lx}	V _{OUT} =18V	-	-	20.0	V	①
Lx Switch On Resistance	R _{SWON}	V _{DD} =3.6V, V _{Lx} =0.4V, R _{pull} =10Ω	-	2.0	4.0	Ω	②
Lx Leak Current	I _{LxL}	Same as I _{STB}	-	-	1	μA	③
CE "High" Voltage	V _{CEH}	Applied voltage to CE when Lx pin voltage holding "H" level	0.65	-	-	V	②
CE "Low" Voltage	V _{CEL}	Applied voltage to CE when Lx pin voltage holding "H" level	-	-	0.20	V	②
Soft-Start Threshold Voltage	V _{SST}	V _{FB} =0.95V, Applied voltage to CE when Lx voltage holding "H" level	1.3	1.6	1.9	V	②
CE "High" Current	I _{CEH}	Same as I _{DD2}	-0.1	-	0.1	μA	③
CE "Low" Current	I _{CEL}	Same as I _{STB}	-0.1	-	0.1	μA	③
FB "High" Current	I _{FBH}	Same as I _{DD2}	-0.1	-	0.1	μA	③
FB "Low" Current	I _{FBL}	Same as I _{STB}	-0.1	-	0.1	μA	③

Test Condition: Unless otherwise stated, V_{IN}=3.0V, V_{CE}=3.0V, V_{FB}=0V, V_{pull}=5.0V, R_{pull}=100Ω.

NOTE:

*1: EFFI={(output voltage x output current) / (input voltage) x (input current)} x 100

TYPICAL APPLICATION CIRCUIT

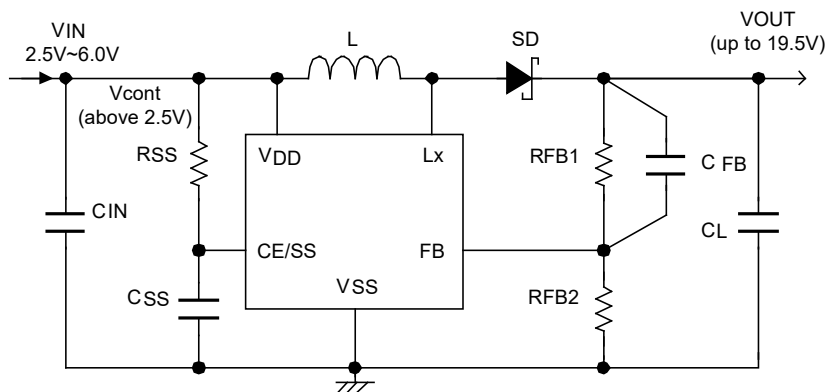

■ OPERATIONAL EXPLANATION

The XC9119 series consists of a reference voltage source, ramp wave circuit, error amplifier, PWM comparator, phase compensation circuit, driver transistor, current limiter circuit and others. The series ICs compare, using the error amplifier, the voltage of the internal reference voltage source with the feedback voltage from the FB pin. Phase compensation is performed on the resulting error amplifier output, to input a signal to the PWM comparator to determine the turn-on time during switching. The PWM comparator compares, in terms of voltage level, the signal from the error amplifier with the ramp wave from the ramp wave circuit, and delivers the resulting output to the buffer drive circuit to cause the Lx pin to output a switching duty cycle. This process is continuously performed to ensure stable output voltage. The current feedback circuit detects the N-channel MOS driver transistor's current for each switching operation, and modulates the error amplifier output signal to provide multiple feedback signals. This enables a stable feedback loop even when a low ESR capacitor, such as a ceramic capacitor, is used, ensuring stable output voltage.

<Reference Voltage Source>

The reference voltage source provides the reference voltage to ensure stable output voltage of the IC.

<Ramp Wave Circuit>

The ramp wave circuit determines switching frequency. The 1MHz (TYP.) of frequency is fixed internally. Clock pulses generated in this circuit are used to produce ramp waveforms needed for PWM operation.

<Error Amplifier>

The error amplifier is designed to monitor output voltage. The amplifier compares the reference voltage with the FB pin voltage. When a voltage lower than the reference voltage is fed back, the output voltage of the error amplifier increases. Gain and frequency characteristics of the error amplifier output are fixed internally as an optimize signal.

<Current Limit >

The current limit circuit of the XC9119 series monitors the current flowing through the N-channel MOS driver transistor connected to the Lx pin, and features a combination of the constant-current type current limit mode and the duty cycle limit of the next pulse.

- ①When the driver current is greater than a specific level, the constant-current type current limit function operates to turn off the pulses from the Lx pin at any given timing.
- ②The IC controls the next pulse to be smaller than the first pulse.

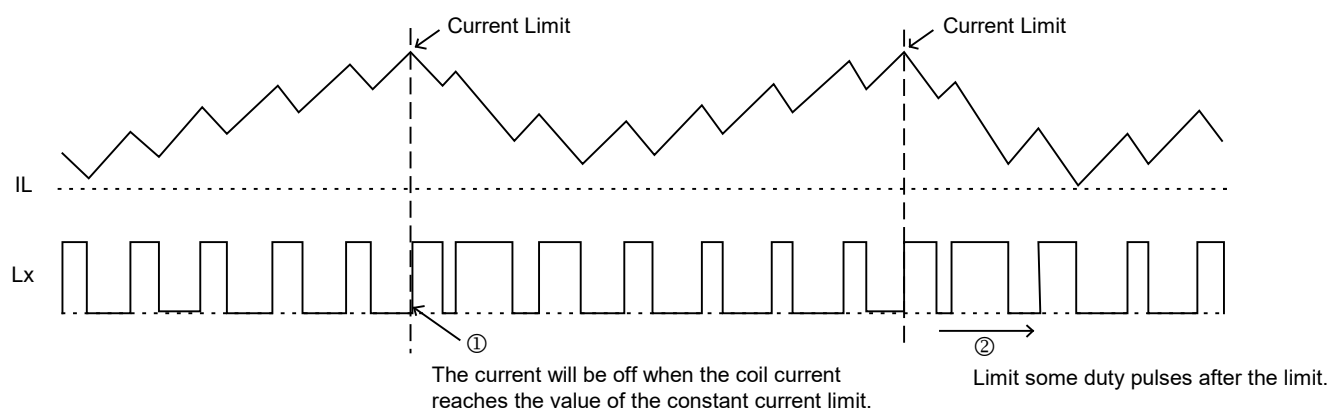

<CE Pin Function>

The operation of the XC9119 series will enter into the shut down mode when a low level signal is input to the CE pin. During the shutdown mode, the supply current is 0 μ A (TYP.), with high impedance at the Lx pin. The IC starts its operation with a high level signal to the CE pin. The input to the CE pin is a CMOS input and the sink current is 0 μ A (TYP.). The hysteresis between the chip enable and the chip disable is 50mV (TYP.).

<Soft-Start Time>

Soft-start function operates when capacitors and resistors are connected to the CE/SS pin. With the Vref voltage limited by the CE/SS pin start-up voltage and applying the input to the error amps, the operation maintains a balance between the two inputs of the error amps. and controls the Lx pin's ON time so that it doesn't increase more than is necessary. Depending on current limit function, load current, step-up ratio, and external components, the IC takes about 500 μ s to 5ms to attain the setting voltage after applying the CE 'H' voltage even though the RSS is 0 Ω and a soft start capacitor C_{SS} is not connected. (For a numerical constant, please refer to Note on Use.) For longer soft-start time, please connect RSS and CSS. Soft-start function operates while the CE pin voltage is between 0V to around 1.9V. Please be noted that if the CE/SS pin voltage does not start from 0V but is in intermediate potential when the power is turned on etc., soft start function may lose an effect and that will cause a high inrush current and ripple voltage.

OPERATIONAL EXPLANATION (Continued)

<CE/SS : Chip Enable / Soft-Start Pin>

CE/SS pin can be used as in either chip enable (CE) pin or soft-start (SS) pin. The IC takes about 5ms at most to attain the setting voltage after starting operation (CE 'H') even though the R_{ss} is 0Ω and the C_{ss} is not connected.

Soft-start function is good for setting a longer time than the start-up time when the R_{ss} is 0Ω and the C_{ss} is not connected. Soft-start operates while the CE pin voltage increases from 0V to around 1.9V. The following equation is used with the values of V_{cont} voltage, the R_{ss} and the C_{ss} .

$$t = - C_{ss} \times R_{ss} \times \ln \{ (V_{cont} - 1.6) / V_{cont} \}$$

- Start-up waveform when the R_{ss} is 0Ω and the C_{ss} is not connected

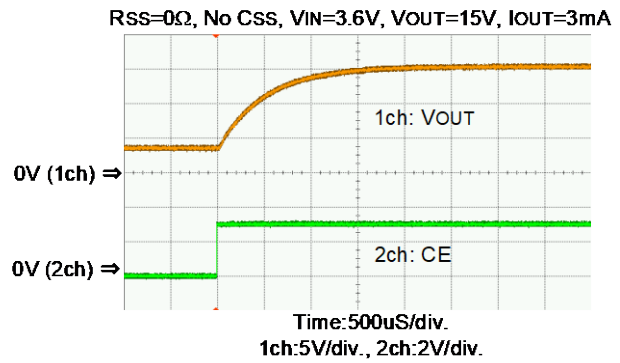

Ex.) When $C_{ss}=0.1\mu F$, $R_{ss}=220k\Omega$, $V_{cont}=5V$,
 $t = -0.1 \times 10^{-6} \times 220 \times 10^3 \times \ln((5-1.6)/5) = 8.48ms$

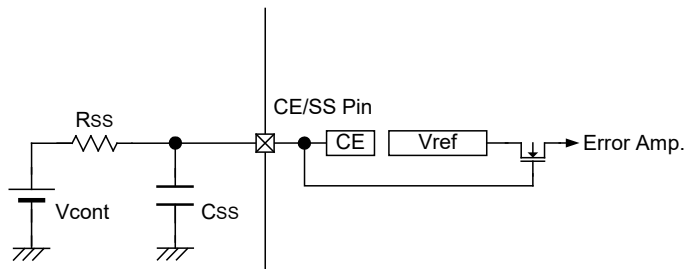

Ex.) Reference Circuit 1: N-ch Open Drain

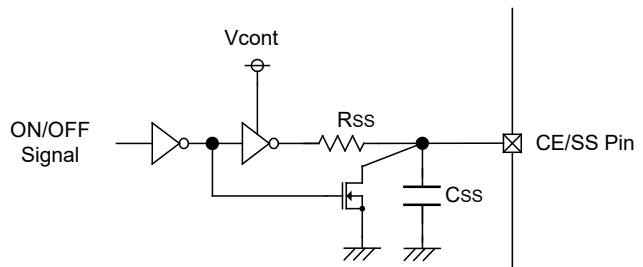

Ex.) Reference Circuit 2: CMOS Logic (Low Supply Current)

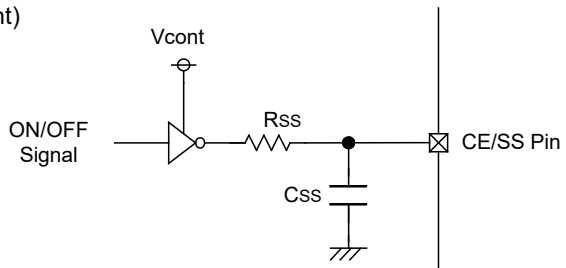

Ex.) Reference Circuit 3: CMOS Logic (Low Supply Current), Quick-Off

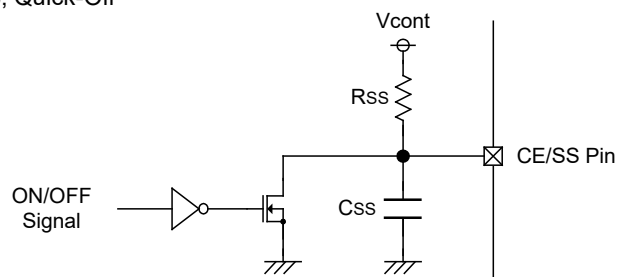

■ OPERATIONAL EXPLANATION (Continued)

<Lx : Switch Pin>

Please connect the anode of a Schottky barrier diode and inductor to the Lx pin.

<FB : Voltage Feedback Pin>

The reference voltage is 1.0V (TYP.). Output voltage is approximated by the following equation according to the value for two resistors (RFB1 and RFB2). The sum of the two resistors should be 1MΩ or less.

$$V_{OUT} = R_{FB1} / R_{FB2} + 1$$

Output voltage should be set as to fill $V_{OUT} < (\text{Maximum value of } V_{Lx}) - (V_F \text{ of Schottky diode})$.

Please adjust the CFB value of the speed-up capacitor for phase compensation so that $f_{zfb} = 1 / (2 \pi \times C_{FB} \times R_{FB1})$ will be about 500Hz. According to the usage, adjusting the inductance value, the load capacity value, and so on to the most suitable operation.

Typical example:

V _{OUT} (V)	R _{FB1} (kΩ)	R _{FB2} (kΩ)	C _{FB} (pF)
3.3	300	130	1000
5.0	300	75	1000
7.0	180	30	1800
10.0	270	30	1200
15.0	510	36	510
18.0	510	30	510

<VDD : Power Supply Pin>

Please connect an input by-pass capacitor (C_{IN}).

● Application Information

<Obtaining VDD from other source than V_{IN}>

In case that the input voltage V_{IN} and power source VDD in the step-up circuit are isolated, the circuit starts step-up operations with the input voltage less than 2.5V when voltage from 2.5V to 6.0V is applied to the power source. Please connect more than 1μF of CDD between the VDD pin and the VSS pin as close as possible.

Ex.) When VDD=3.6V, V_{IN}=1.8V, V_{OUT}=5.0V (R_{FB1}=300kΩ, R_{FB2}=75kΩ, C_{FB}=1000pF, C_L=10μF), the IC can operate up to I_{OUT}=40mA.

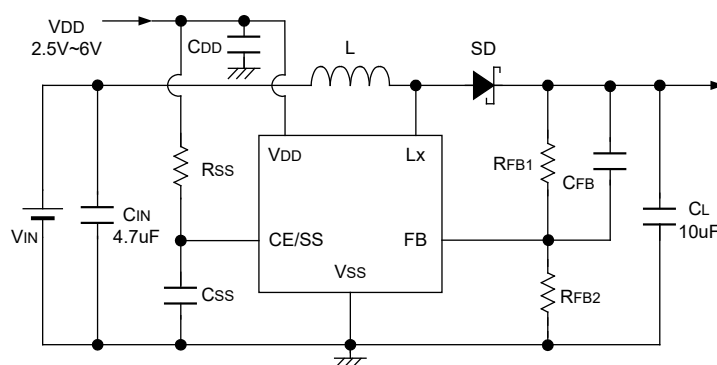

■ NOTES ON USE

1. For temporary, transitional voltage drop or voltage rising phenomenon, the IC is liable to malfunction should the ratings be exceeded.
2. Please do not exceed the value of stated absolute maximum ratings.
3. The DC/DC converter performance is greatly influenced by not only the ICs' characteristics, but also by those of the external components. Care must be taken when selecting the external components.
4. Make sure that the PCB GND traces are as thick as possible, as variations in ground potential caused by high ground currents at the time of switching may result in instability of the IC.
5. Please mount each external component as close to the IC as possible and use thick, short connecting traces to reduce the circuit impedance.
6. Please set up the output voltage value so that the Lx pin voltage does not exceed 20V.
7. Torex places an importance on improving our products and their reliability. We request that users incorporate fail-safe designs and post-aging protection treatment when using Torex products in their systems.

TEST CIRCUITS

Circuit ①

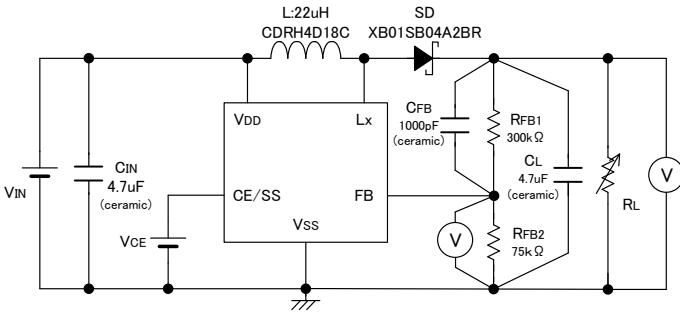

Circuit ②

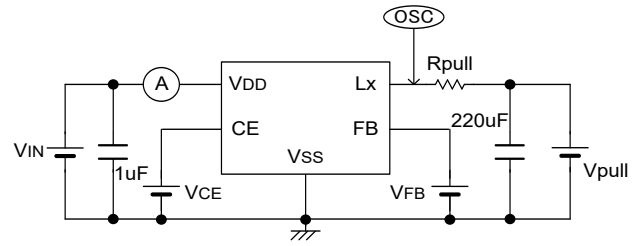

Circuit ③

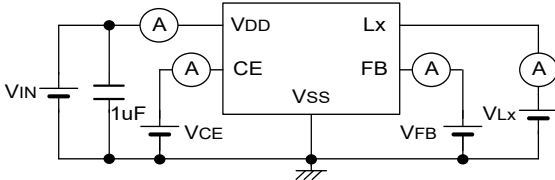

Circuit ④

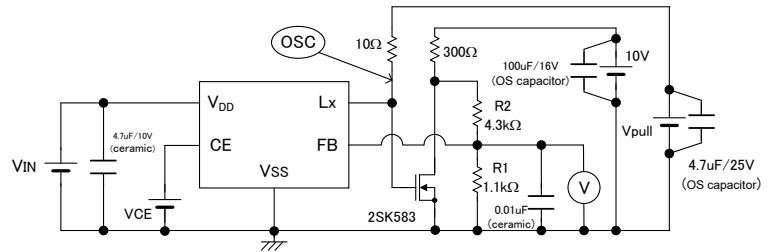

1. The measurement method of Lx On resistance R_{SWON}

Using the circuit ②, Lx On resistance can be measured by adjusting V_{pull} voltage to set Lx voltage V_{Lx} x 0.4V when the driver transistor is ON. The oscilloscope is used for measuring the Lx voltage when the driver transistor is ON.

$$R_{SWON} = 0.4 / \{(V_{pull} - 0.4) / 10\}$$

2. The measurement method of current limit I_{LIM}

Using the circuit ④, current limit I_{LIM} can be calculate by the equation including V_{pull} voltage when FB voltage is decreased while V_{pull} voltage is adjusted and Lx voltage V_{Lx} when the driver transistor is ON. The oscilloscope is used for measuring the Lx voltage when the driver transistor is ON.

$$I_{LIM} = (V_{pull} - V_{Lx}) / R_{pull}$$

TYPICAL PERFORMANCE CHARACTERISTICS

(1) Output Voltage vs. Output Current

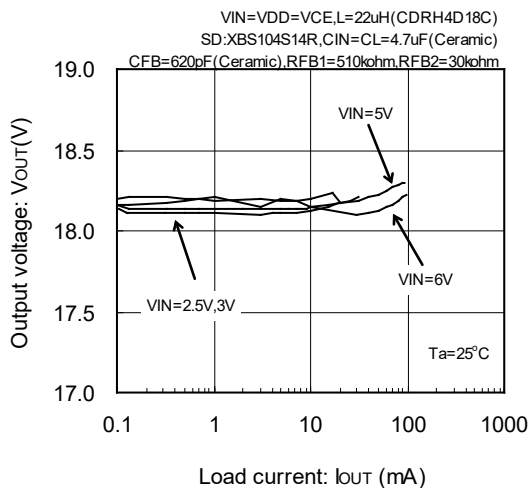
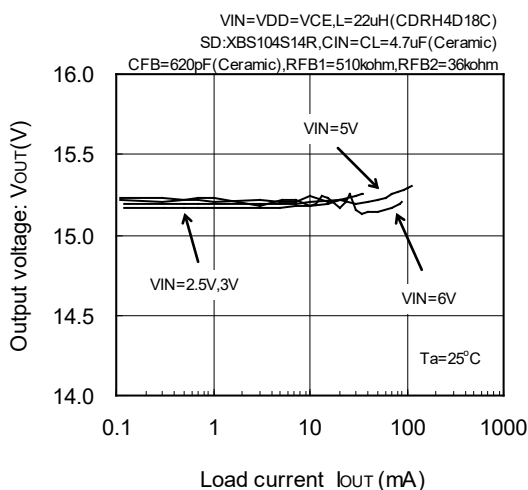
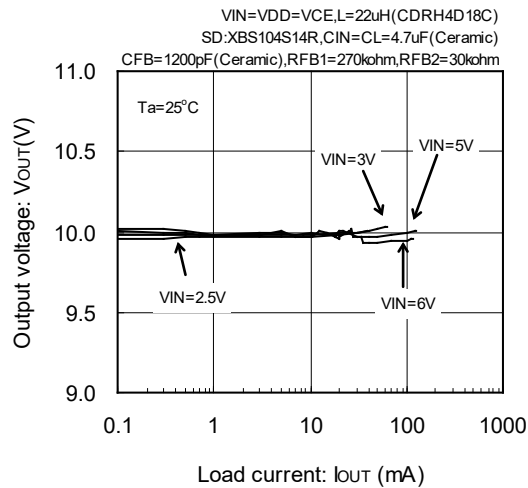
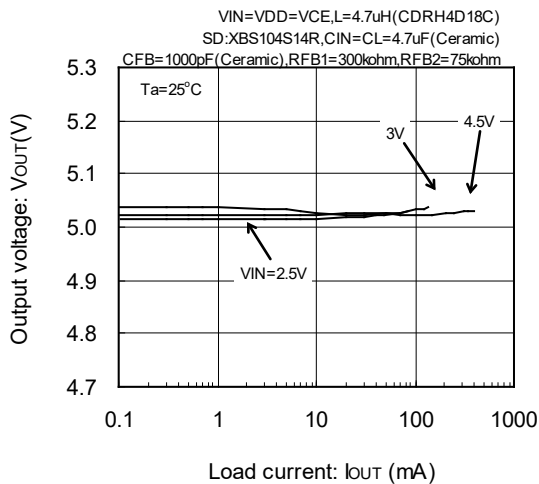

(2) Efficiency vs. Output Current

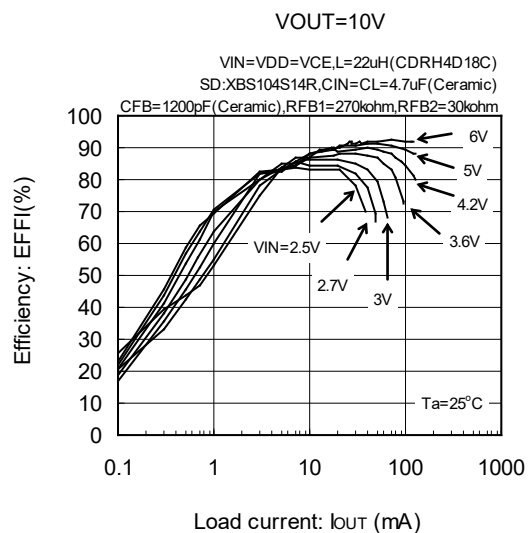
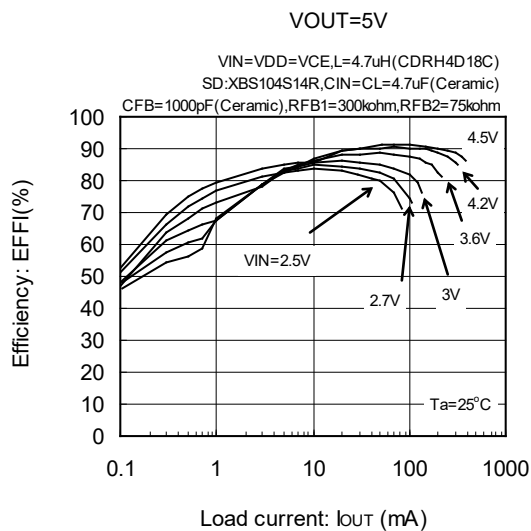

TYPICAL PERFORMANCE CHARACTERISTICS (Continued)

(2) Efficiency vs. Output Current (Continued)

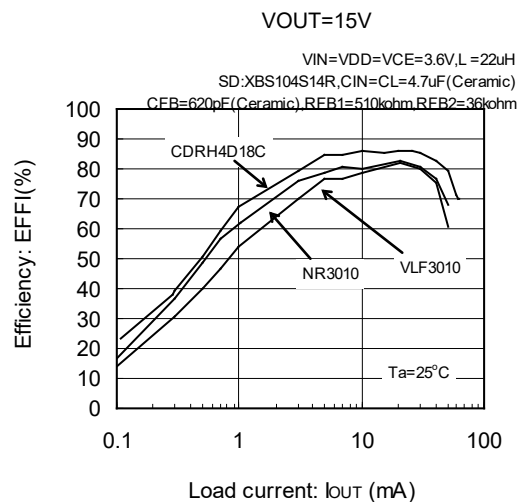
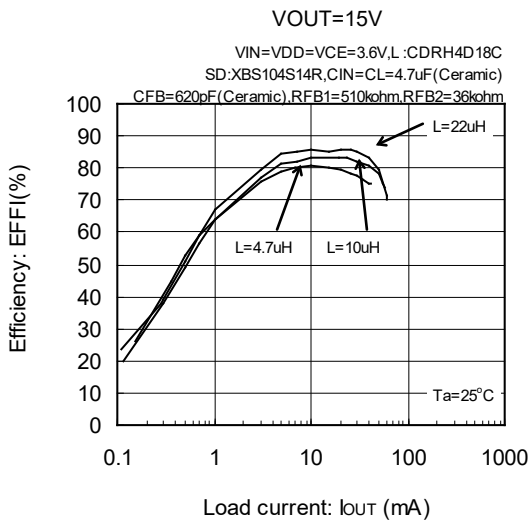
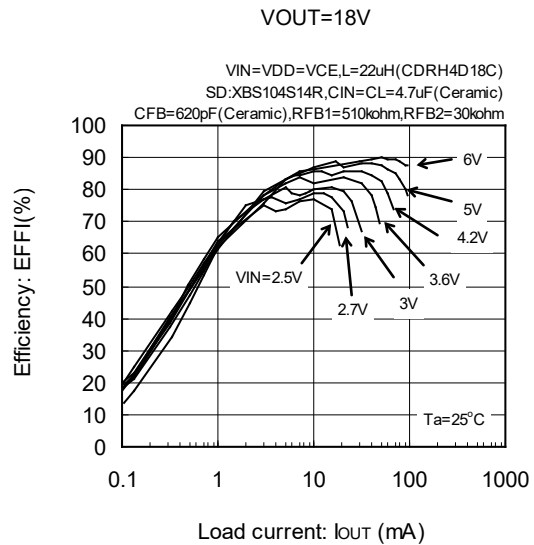
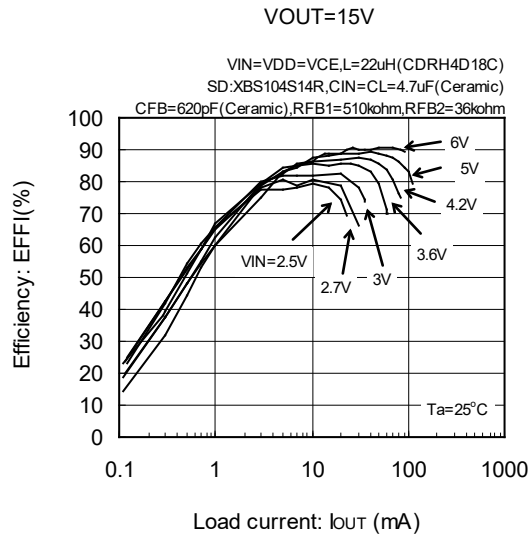

(3) Ripple Voltage vs. Output Current

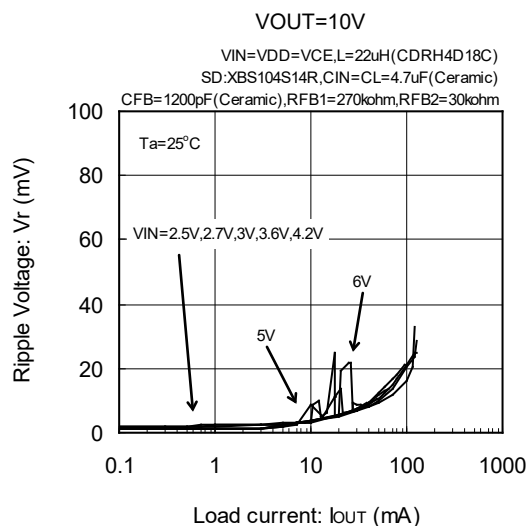
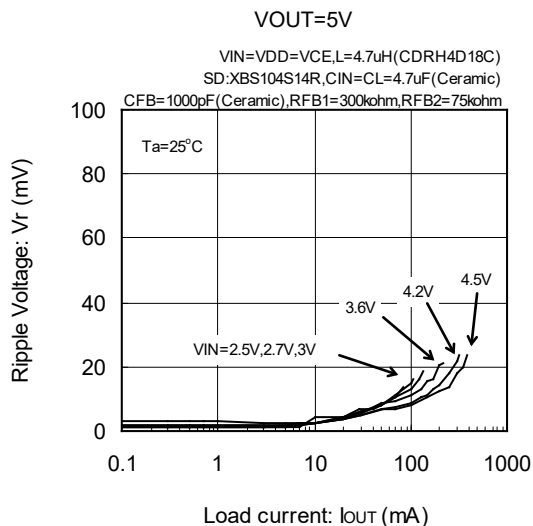

■ TYPICAL PERFORMANCE CHARACTERISTICS (Continued)

(3) Ripple Voltage vs. Output Current (Continued)

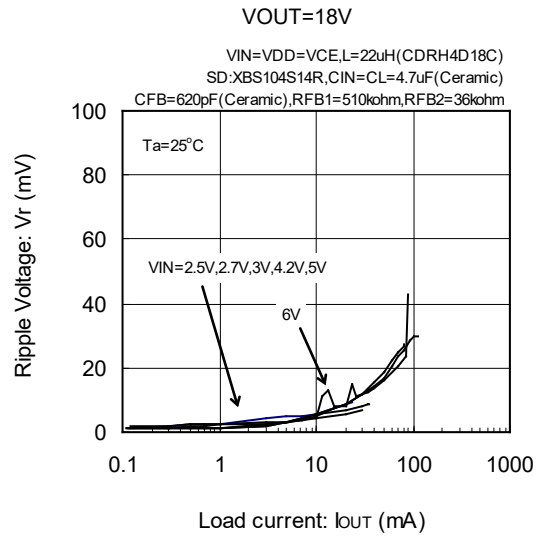
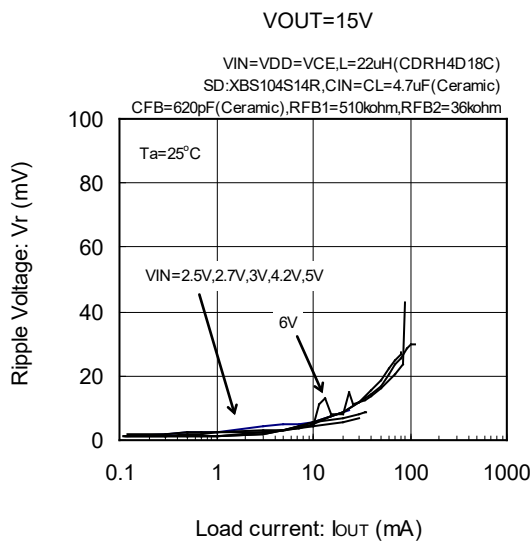

(4) Maximum Output Current vs. Input Voltage

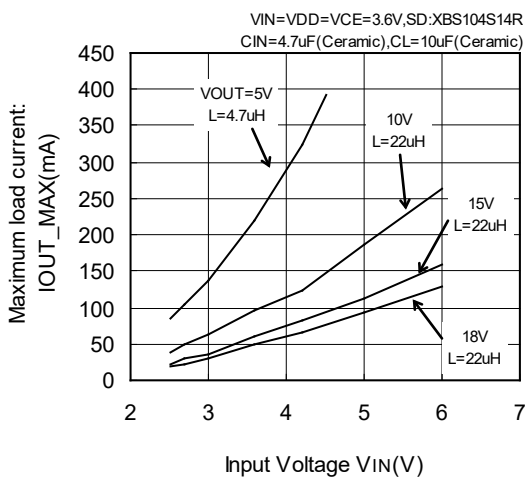

(5) Feedback Voltage vs. Chip Enable Voltage

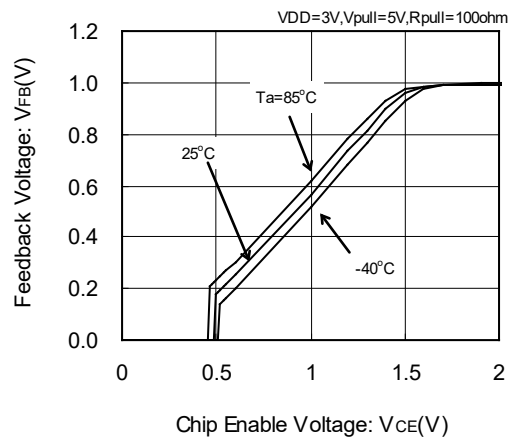

(6) Supply Current 1 vs. Supply Voltage

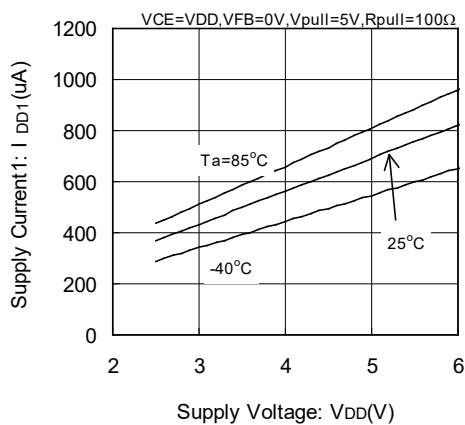

(7) Supply Current 2 vs. Supply Voltage

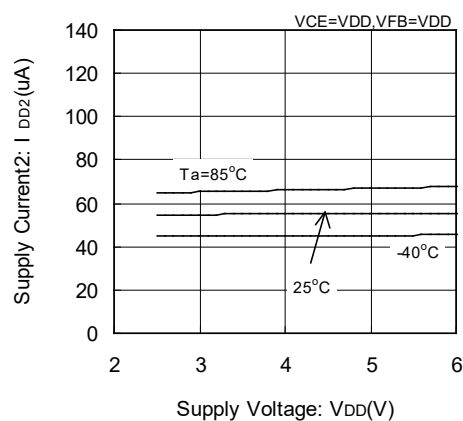

TYPICAL PERFORMANCE CHARACTERISTICS (Continued)

(8) Oscillation Frequency vs. Supply Voltage

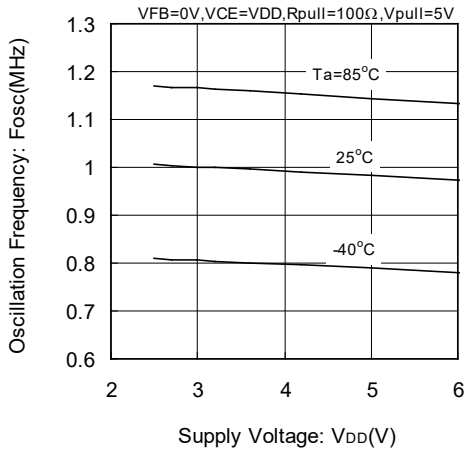

(9) Maximum Duty Cycle vs. Supply Voltage

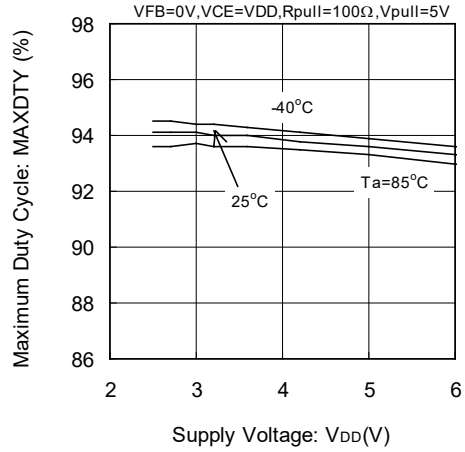

(10) Stand-by Current vs. Supply Voltage

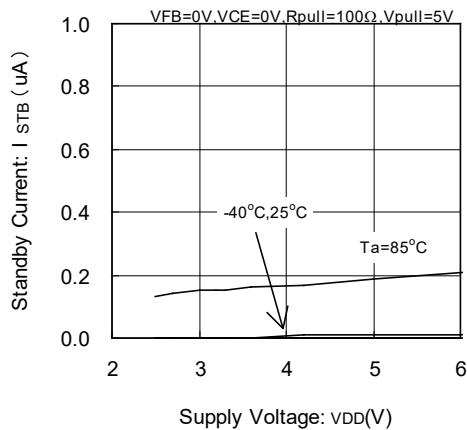

(11) Lx ON Resistance vs. Supply Voltage

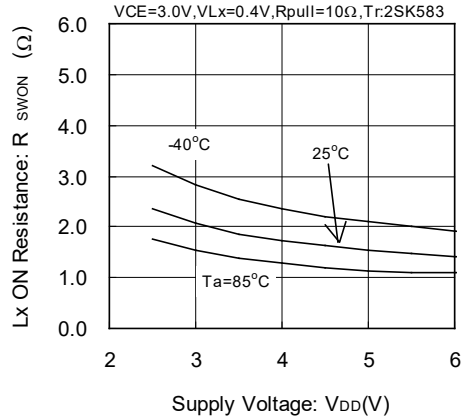

(12) Current Limit vs. Supply Voltage

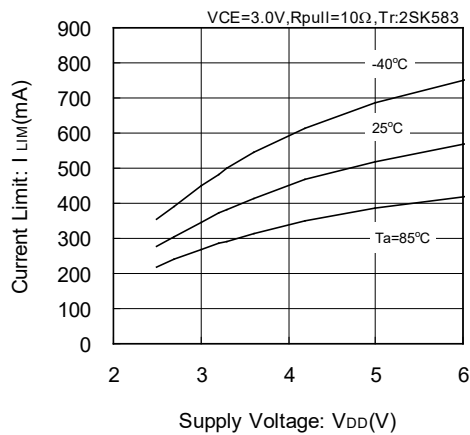

(13) Feedback Voltage vs. Supply Voltage

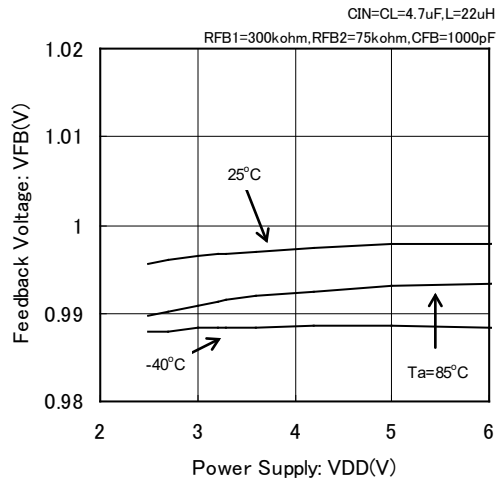

■ TYPICAL PERFORMANCE CHARACTERISTICS (Continued)

(14) CE 'H' Voltage vs. Supply Voltage

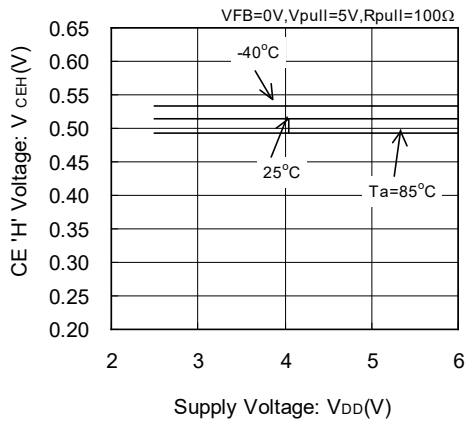

(15) CE 'L' Voltage vs. Supply Voltage

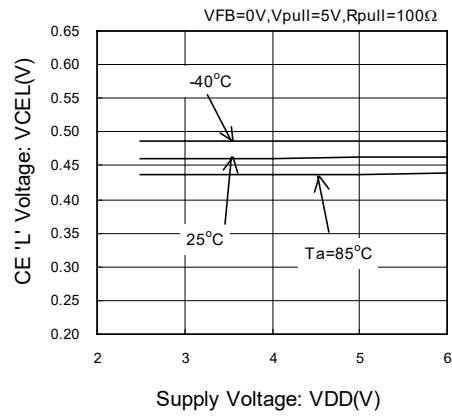

(16) Load Transient Response

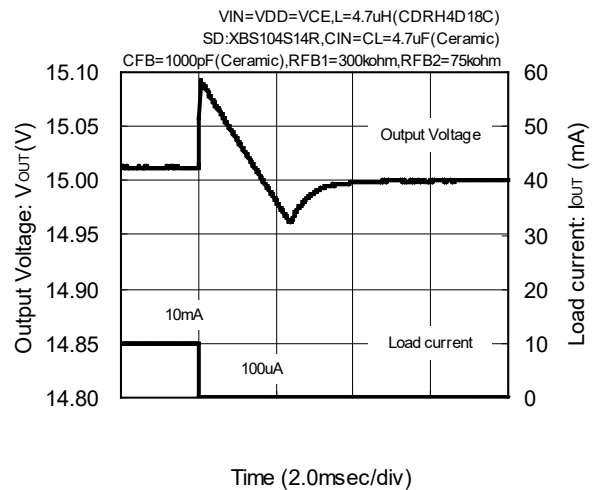
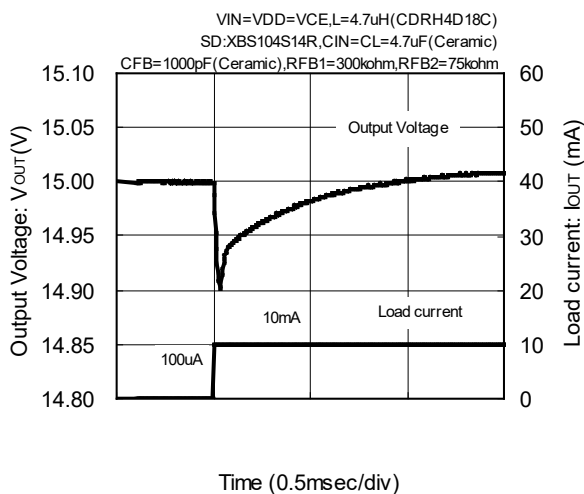
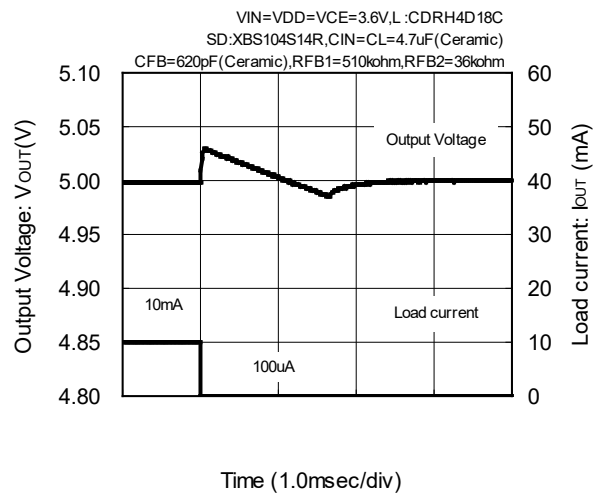
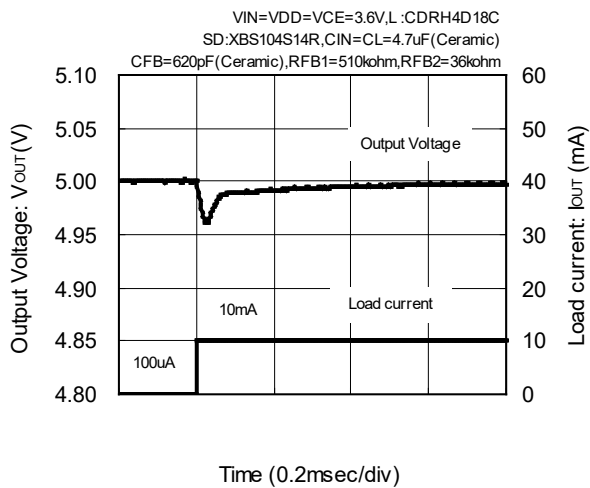

TYPICAL PERFORMANCE CHARACTERISTICS (Continued)

(17) Maximum Output Current vs. Input Voltage

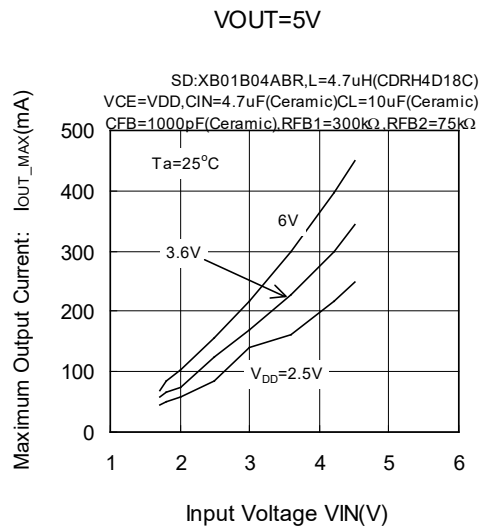
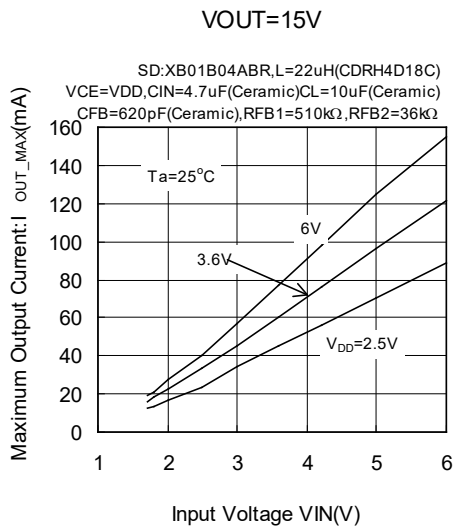

■ PACKAGING INFORMATION

For the latest package information go to, www.torexsemi.com/technical-support/packages

PACKAGE	OUTLINE / LAND PATTERN	THERMAL CHARACTERISTICS
SOT-25	SOT-25 PKG	SOT-25 Power Dissipation
USP-6C	USP-6C PKG	USP-6C Power Dissipation

MARKING RULE

● SOT-25

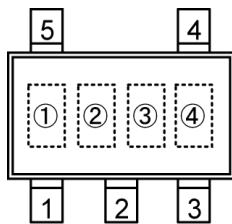

SOT-25
(TOP VIEW)

① represents product series

MARK	PRODUCT SERIES
L	XC9119xxxxMx

② represents Lx overvoltage limit

MARK	Lx OVERVOLTAGE LIMIT	PRODUCT SERIES
D	Not Available	XC9119DxxxMx

③ represents oscillation frequency

MARK	OSCILLATION FREQUENCY	PRODUCT SERIES
A	1MHz	XC9119xxxAMx

④ represents production lot number

0 to 9 and A to Z, or inverted characters 0 to 9 and A to Z repeated.
(G, I, J, O, Q, W excepted)

● USP-6C

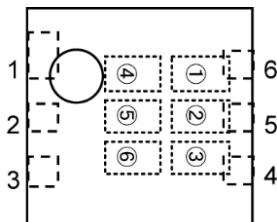

USP-6C
(TOP VIEW)

① represents product series

MARK	PRODUCT SERIES
V	XC9119xxxxDx

② represents Lx overvoltage limit

MARK	Lx OVERVOLTAGE LIMIT	PRODUCT SERIES
D	Not Available	XC9119DxxxDx

③④ represents FB voltage

MARK		FB VOLTAGE (V)	PRODUCT SERIES
③	④		
1	0	1.0	XC9119x10xDx

⑤ represents oscillation frequency

MARK	OSCILLATION FREQUENCY	PRODUCT SERIES
A	1MHz	XC9119xxxADx

⑥ represents production lot number

0 to 9 and A to Z repeated (G, I, J, O, Q, W excepted)
* No character inversion used.

1. The product and product specifications contained herein are subject to change without notice to improve performance characteristics. Consult us, or our representatives before use, to confirm that the information in this datasheet is up to date.
2. The information in this datasheet is intended to illustrate the operation and characteristics of our products. We neither make warranties or representations with respect to the accuracy or completeness of the information contained in this datasheet nor grant any license to any intellectual property rights of ours or any third party concerning with the information in this datasheet.
3. Applicable export control laws and regulations should be complied and the procedures required by such laws and regulations should also be followed, when the product or any information contained in this datasheet is exported.
4. The product is neither intended nor warranted for use in equipment of systems which require extremely high levels of quality and/or reliability and/or a malfunction or failure which may cause loss of human life, bodily injury, serious property damage including but not limited to devices or equipment used in 1) nuclear facilities, 2) aerospace industry, 3) medical facilities, 4) automobile industry and other transportation industry and 5) safety devices and safety equipment to control combustions and explosions. Do not use the product for the above use unless agreed by us in writing in advance.
5. Although we make continuous efforts to improve the quality and reliability of our products; nevertheless Semiconductors are likely to fail with a certain probability. So in order to prevent personal injury and/or property damage resulting from such failure, customers are required to incorporate adequate safety measures in their designs, such as system fail safes, redundancy and fire prevention features.
6. Our products are not designed to be Radiation-resistant.
7. Please use the product listed in this datasheet within the specified ranges.
8. We assume no responsibility for damage or loss due to abnormal use.
9. All rights reserved. No part of this datasheet may be copied or reproduced unless agreed by Torex Semiconductor Ltd in writing in advance.

TOREX SEMICONDUCTOR LTD.