	<b>E480232</b>
---	----------------

**Features**

- For Surface Mount Applications in Order to Optimize Board Space
- Excellent Clamping Capability  
Fast Response Time: Typical Less Than 1.0ps From 0 Volts to  $V_B$  Minimum
- Ideal for Data Line Applications
- Halogen Free. "Green" Device (Note 1)
- Moisture Sensitivity Level 1
- Epoxy Meets UL 94 V-0 Flammability Rating
- Lead Free Finish/RoHS Compliant (Note 2) ("P" Suffix Designates RoHS Compliant. See Ordering Information)

**Mechanical Data**

- Terminals: Solderable Per MIL-STD-750, Method 2026
- The Band Denotes TVS Cathode
- Maximum Soldering Temperature: 260°C for 10 Seconds

**Maximum Ratings**

- Operating Junction Temperature Range: -55°C to +175°C
- Storage Temperature Range: -55°C to +175°C

**Electrical Characteristics @ 25°C Unless Otherwise Specified**

Peak Pulse Power Surge Current on 10/1000µs Waveform	$I_{PP}$	See the Table	Note 3
Peak Pulse Power Dissipation	$P_{PP}$	500W	Note 3,4
Steady State Power Dissipation	$P_D$	3.0W	$T_L = 75^\circ\text{C}$ With at lengths 0.375"(9.5mm)

**Notes:**

1. Halogen free "Green" products are defined as those which contain <900ppm bromine, <900ppm chlorine (<1500ppm total Br + Cl) and <1000ppm antimony compounds.
2. High Temperature Solder Exemption Applied, see EU Directive Annex 7a.
3. Non-repetitive current pulse, per Fig.3 and derated above  $T_A=25^\circ\text{C}$  per Fig.4.
4. Mounted on 5.0mm<sup>2</sup> copper pads to each terminal.

Transient Voltage Suppressors

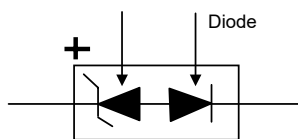

Schematic Diagram

**500 Watt TVS  
5 to 50 Volts**

**SMB (DO-214AA)  
(LEAD FRAME)**

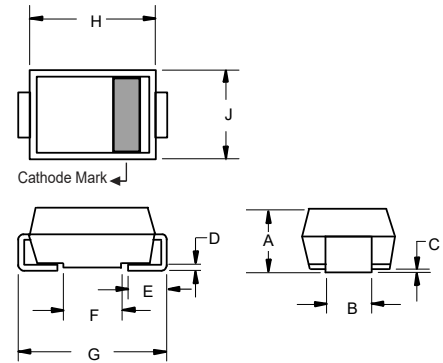

DIM	INCHES		MM		NOTE
	MIN	MAX	MIN	MAX	
A	0.079	0.103	2.00	2.62	
B	0.075	0.087	1.91	2.21	
C	0.002	0.008	0.05	0.20	
D	0.006	0.012	0.15	0.31	
E	0.030	0.060	0.76	1.52	
F	0.065	0.091	1.65	2.32	
G	0.200	0.220	5.08	5.59	
H	0.160	0.191	4.06	4.85	
J	0.130	0.155	3.30	3.94	

**Suggested Solder Pad Layout**

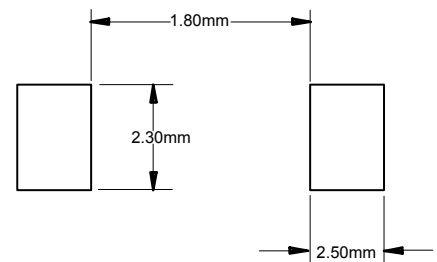

Electrical Characteristics @ 25°C Unless Otherwise Specified

MCC PART NUMBERS	STAND- OFF VOLTAGE V <sub>WM</sub> (VOLTS)	MINIMUM BREAKDOWN VOLTAGE AT I <sub>T</sub> =1.0mA V <sub>(BR)</sub> (VOLTS)	MAXIMUM REVERSE LEAKAGE AT V <sub>WM</sub> I <sub>R</sub> (μA)	MAXIMUM CLAMPING VOLTAGE AT I <sub>pp</sub> =5.0A V <sub>C</sub> (V)	MAXIMUM PEAK PULSE CURRENT PER FIG.3 I <sub>pp</sub> (AMPS)	MAXIMUM JUNCTION CAPACITANCE AT 0 VOLTS (pF)	WORKING INVERSE BLOCKING VOLTAGE V <sub>WIB</sub> (VOLTS)	INVERSE BLOCKING LEAKAGE CURRENT V <sub>WIB</sub> IIB(mA)	PEAK INVERSE BLOCKING VOLTAGE V <sub>PIB</sub> (VOLTS)	Marking Code
SMBSAC5.0	5.0	7.6	300	10.0	44.0	45	75	1.0	100	SKE
SMBSAC6.0	6.0	7.9	300	11.2	41.0	45	75	1.0	100	SKG
SMBSAC7.0	7.0	8.3	300	12.6	38.0	45	75	1.0	100	SKM
SMBSAC8.0	8.0	8.9	100	13.4	36.0	45	75	1.0	100	SKR
SMBSAC8.5	8.5	9.44	50	14.0	34.0	45	75	1.0	100	SKT
SMBSAC10	10.0	11.10	5	16.3	29.0	45	75	1.0	100	SKX
SMBSAC12	12.0	13.30	5	19.0	25.0	45	75	1.0	100	SLE
SMBSAC15	15.0	16.70	5	23.6	20.0	45	75	1.0	100	SLM
SMBSAC18	18.0	20.00	5	28.8	15.0	45	75	1.0	100	SLT
SMBSAC22	22.0	24.40	5	35.4	14.0	45	75	1.0	100	SLX
SMBSAC26	26.0	28.90	5	42.3	11.1	45	75	1.0	100	SME
SMBSAC30	30.0	33.30	5	48.6	10.0	45	75	1.0	100	SMK
SMBSAC36	36.0	40.00	5	60.0	8.6	45	75	1.0	100	SMP
SMBSAC45	45.0	50.00	5	77.0	6.8	45	150	1.0	200	SMV
SMBSAC50	50.0	55.50	5	88.0	5.8	45	150	1.0	200	SMZ

Curve Characteristics

Fig. 1 - Peak Pulse Power Rating Curve

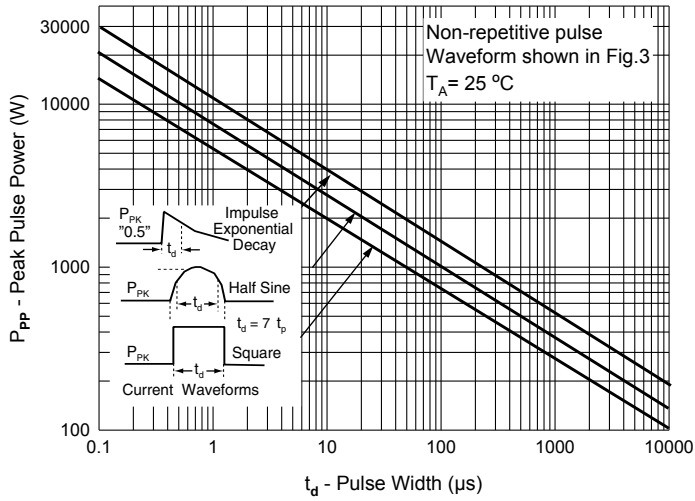

Fig. 2 - Typical Junction Capacitance

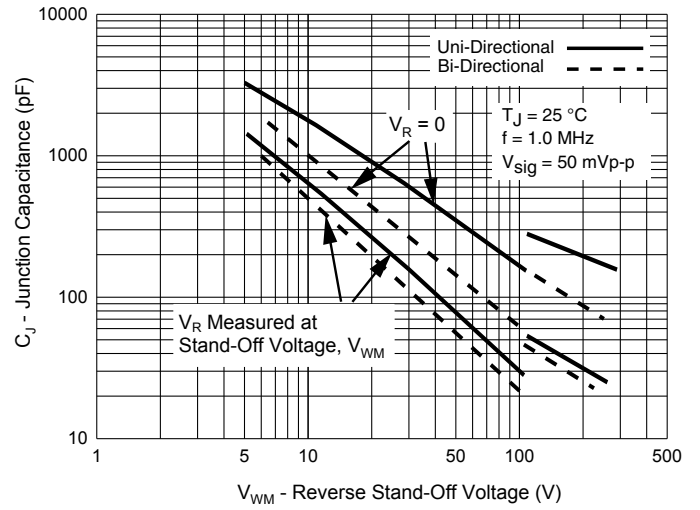

Fig. 3 - Pulse Waveform

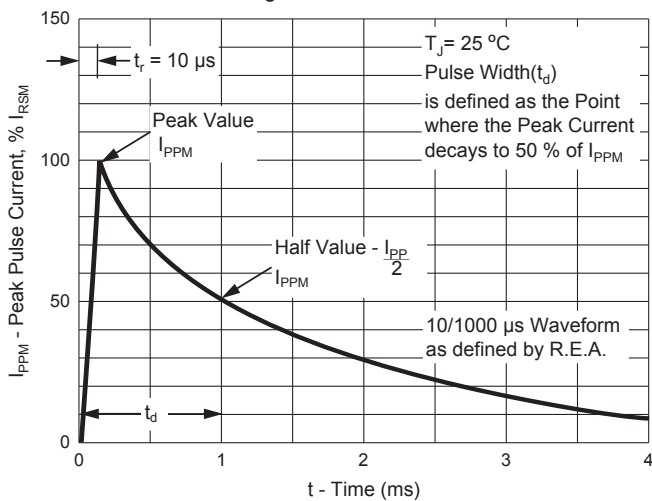
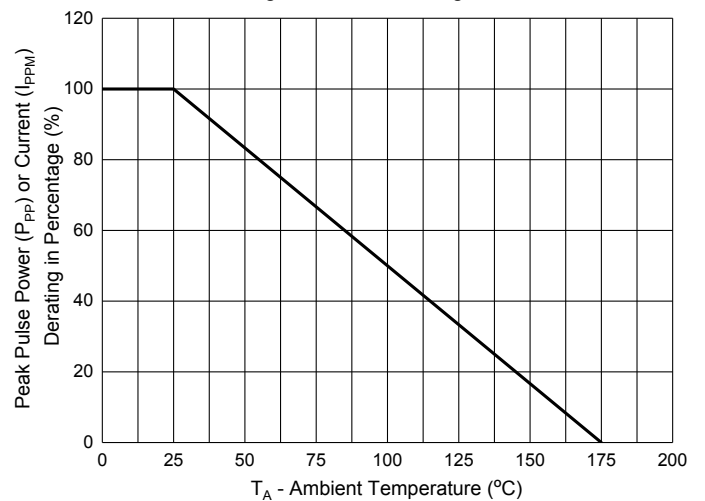

Fig. 4 - Pulse Derating Curve



## Ordering Information

Device	Packing
Part Number-TP	Tape&Reel:3Kpcs/Reel

### \*\*\*IMPORTANT NOTICE\*\*\*

**Micro Commercial Components Corp.** reserves the right to make changes without further notice to any product herein to make corrections, modifications, enhancements, improvements, or other changes. **Micro Commercial Components Corp.** does not assume any liability arising out of the application or use of any product described herein; neither does it convey any license under its patent rights, nor the rights of others. The user of products in such applications shall assume all risks of such use and will agree to hold **Micro Commercial Components Corp.** and all the companies whose products are represented on our website, harmless against all damages. **Micro Commercial Components Corp.** products are sold subject to the general terms and conditions of commercial sale, as published at <https://www.mccsemi.com/Home/TermsAndConditions>.

### \*\*\*LIFE SUPPORT\*\*\*

MCC's products are not authorized for use as critical components in life support devices or systems without the express written approval of Micro Commercial Components Corporation.

### \*\*\*CUSTOMER AWARENESS\*\*\*

Counterfeiting of semiconductor parts is a growing problem in the industry. Micro Commercial Components (MCC) is taking strong measures to protect ourselves and our customers from the proliferation of counterfeit parts. MCC strongly encourages customers to purchase MCC parts either directly from MCC or from Authorized MCC Distributors who are listed by country on our web page cited below. Products customers buy either from MCC directly or from Authorized MCC Distributors are genuine parts, have full traceability, meet MCC's quality standards for handling and storage. **MCC will not provide any warranty coverage or other assistance for parts bought from Unauthorized Sources.** MCC is committed to combat this global problem and encourage our customers to do their part in stopping this practice by buying direct or from authorized distributors.