

**SINGLE-PHASE GLASS PASSIVATED
SILICON BRIDGE RECTIFIER**

VOLTAGE RANGE 50 to 1000 Volts CURRENT 10 Amperes

FEATURES

- * Low leakage
- * Low forward voltage
- * Mounting position : Any
- * Surge overload rating: 200 Amperes peak
- * Ideal for printed circuit boards
- * MSL: Level 1

MECHANICAL DATA

- * UL listed the recognized component directory, file #E94233
- * Epoxy: Device has UL flammability classification 94V-0

MAXIMUM RATINGS AND ELECTRICAL CHARACTERISTICS

Ratings at 25 °C ambient temperature unless otherwise specified.
resistive or inductive load.

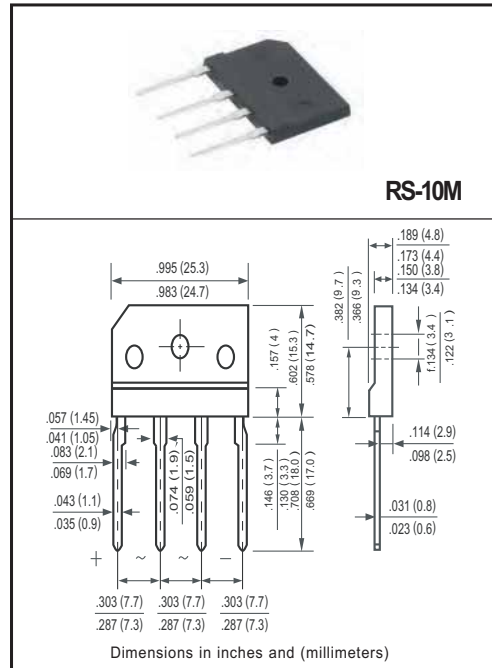

MAXIMUM CHARACTERISTICS (@ TA = 25°C unless otherwise noted)

CHARACTERISTICS	SYMBOL	RS1001M	RS1002M	RS1003M	RS1004M	RS1005M	RS1006M	RS1007M	UNITS
Maximum Recurrent Peak Reverse Voltage	V _{RRM}	50	100	200	400	600	800	1000	Volts
Maximum RMS Bridge Input Voltage	V _{RMS}	35	70	140	280	420	560	700	Volts
Maximum DC Blocking Voltage	V _{DC}	50	100	200	400	600	800	1000	Volts
Maximum Average Forward Rectified Output Current at T _c =100 degree with heatsink	I _o	10							Amps
Peak Forward Surge Current 8.3 ms single half sine-wave superimposed on rated load	I _{FSM}	200							Amps
Typical Current Square Time	i ² T	166							A ² S
Insulation voltage	V _{iso}	3000							Volts
Typical Thermal Resistance from junction to ambient	R _{θJA}	22							°C/W
Typical Thermal Resistance from junction to case	R _{θJC}	1.0							
Operating and Storage Temperature Range	T _J ,T _{STG}	-55 to + 150							°C

ELECTRICAL CHARACTERISTICS (@ TA = 25°C unless otherwise noted)

CHARACTERISTICS	SYMBOL	RS1001M	RS1002M	RS1003M	RS1004M	RS1005M	RS1006M	RS1007M	UNITS
Maximum Forward Voltage Drop per element at 5.0A DC	@TA=25 °C	1.1							Volts
	@TA=125 °C	0.98							
Maximum Reverse Current at Rated DC Blocking Voltage per element	@TA=25 °C	5.0							μAmps
	@TA=125 °C	30							μAmps

Note: " ROHS compliant".

RATING AND CHARACTERISTICS CURVES (RS1001M THRU RS1007M)

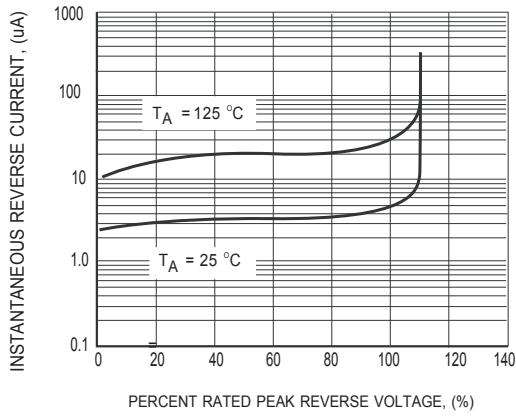

FIG.1 MAXIMUM REVERSE CHARACTERISTICS

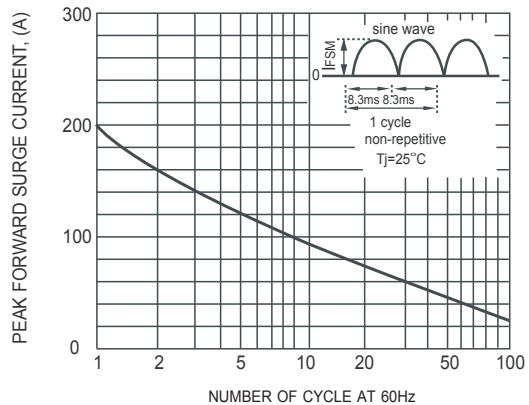

FIG.2 MAXIMUM NON-REPETITIVE FORWARD SURGE CURRENT

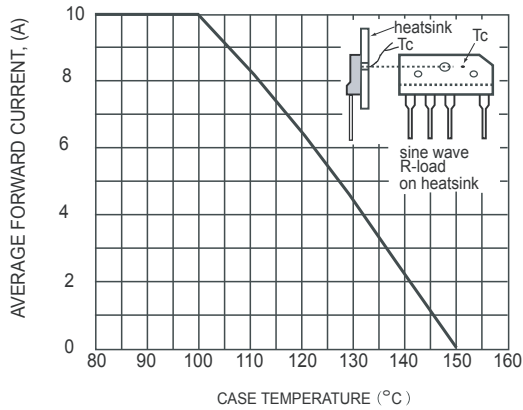

FIG.3 TYPICAL FORWARD CURRENT DERATING CURVE

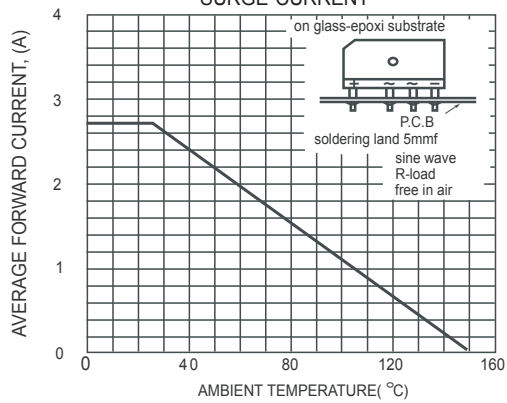

FIG.4 TYPICAL FORWARD CURRENT DERATING CURVE

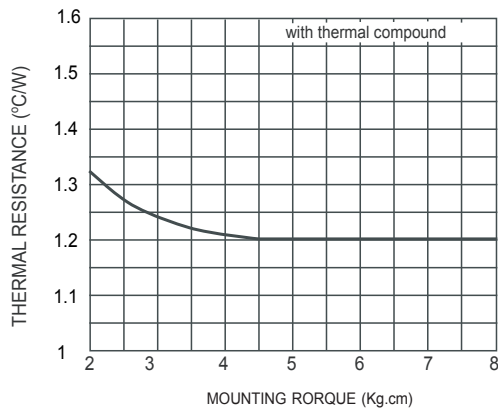

FIG.5 CONTACT THERMAL RESISTANCE

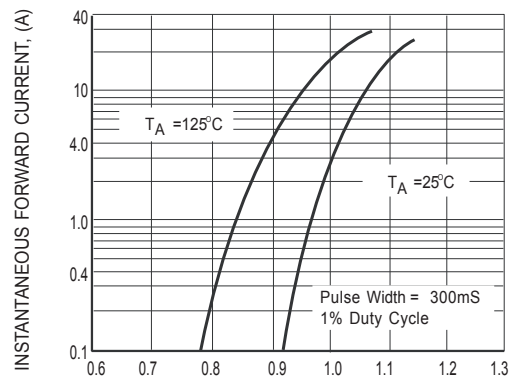
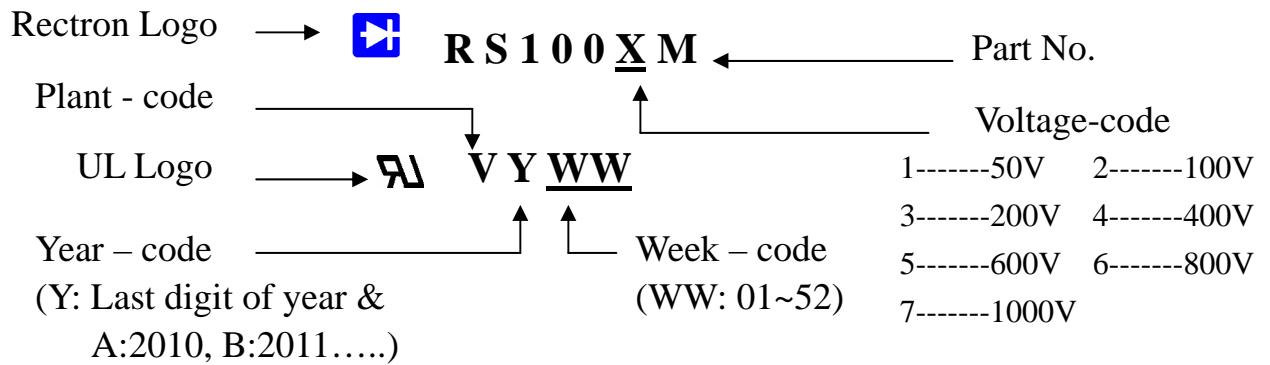

FIG.6 TYPICAL INSTANTANEOUS FORWARD CHARACTERISTICS

Marking Description



PACKAGING OF DIODE AND BRIDGE RECTIFIERS

TUBE PACK

PACKAGE	PACKING CODE	EA PER BOX	INNER BOX SIZE (mm)	CARTON SIZE (mm)	EA PER CARTON	WEIGHT(Kg)
RS-4M/-10M	-C	900	540*118*118	560*259*144	1,800	12.82

DISCLAIMER NOTICE

Rectron Inc reserves the right to make changes without notice to any product specification herein, to make corrections, modifications, enhancements or other changes. Rectron Inc or anyone on its behalf assumes no responsibility or liability for any errors or inaccuracies. Data sheet specifications and its information contained are intended to provide a product description only. "Typical" parameters which may be included on RECTRON data sheets and/ or specifications can and do vary in different applications and actual performance may vary over time. Rectron Inc does not assume any liability arising out of the application or use of any product or circuit.

Rectron products are not designed, intended or authorized for use in medical, life-saving implant or other applications intended for life-sustaining or other related applications where a failure or malfunction of component or circuitry may directly or indirectly cause injury or threaten a life without expressed written approval of Rectron Inc. Customers using or selling Rectron components for use in such applications do so at their own risk and shall agree to fully indemnify Rectron Inc and its subsidiaries harmless against all claims, damages and expenditures.