

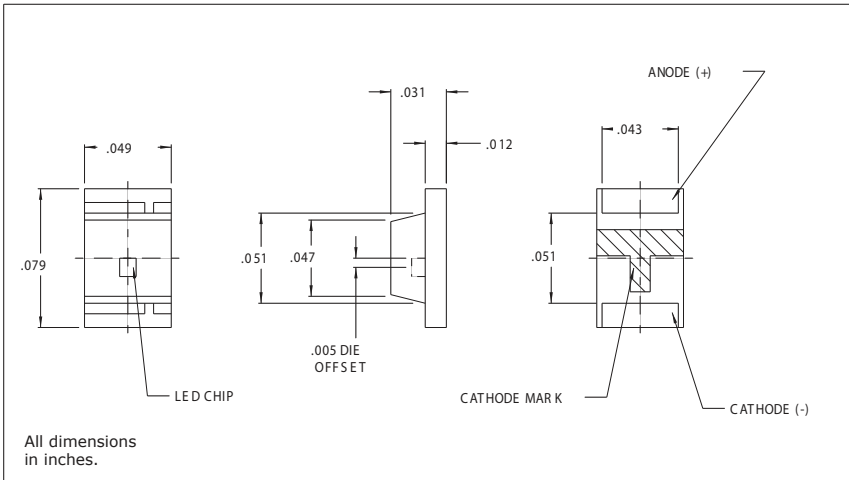

# 7012X Series Bright Chips™ SMT LEDs 0805 Package Size

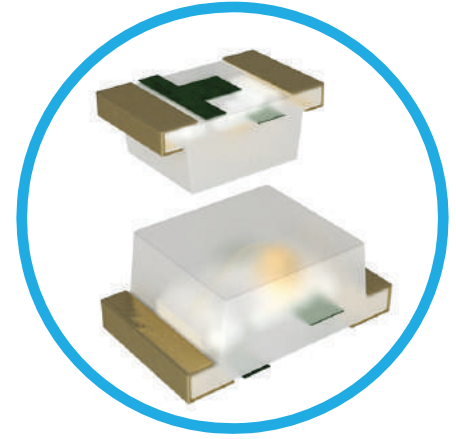

- Premium brightness in miniature chip-type LED assemblies.
- Ideally suited for applications such as telecommunications, dataprocessing peripherals and networking units as replacements for through-hole products.
- Also ideal for backlighting or light pipe applications.
- Compact size: 2mm wide x 1.25mm deep x 1mm high
- 4000 pieces per reel
- REACH and RoHS Compliant
- Integral reflection cup maximizes output
- Compatible with full range of IR and vapor phase reflow processes, and conductive adhesives, to facilitate high-speed board loading.
- Packaged for automatic component placement in pocketed anti-static tape reels.

## Electro-Optical Characteristics and Ratings

PART NUMBER	7012X5	7012X1	7012X7
Output Color	Green	Red	Yellow-Green
Diffusion	Diffused	Diffused	Diffused
Package Color	Clear	Clear	Clear
Test Current (mA)	20	20	20
Forward Voltage Typ. (V)	2.1	1.7	2.1
Forward Voltage Max. (V)	2.5	2.0	2.5
Luminous Intensity Min. (mcd)	3.8	7.0	7.0
Luminous Intensity Typ. (mcd)	6.4	11.7	11.7
Luminous Intensity Max. (mcd)	-	-	-
Peak Wavelength (nm)	560	660	570
Viewing Angle 2θ 1/2 (degrees)	-	-	-
Power Dissipation (mW)	62.5	50	62.5
Operating Temperature (°C)	-40 to +85	-40 to +85	-40 to +85
Storage Temperature (°C)	-40 to +90	-40 to +90	-40 to +90
Peak Forward Current Max. (1µs @ 10% duty cycle) (mA)	60	60	60
Reverse Voltage (IR=100µA) (V)	4	4	4
Lead Solder Time @ 260°C	5	5	5

# Product Specifications

## 7012X5

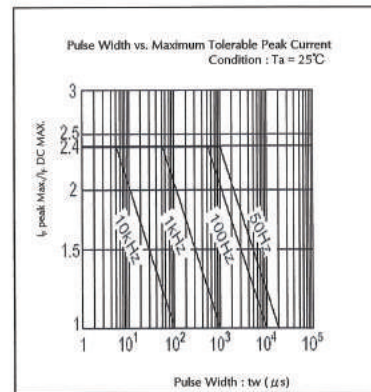
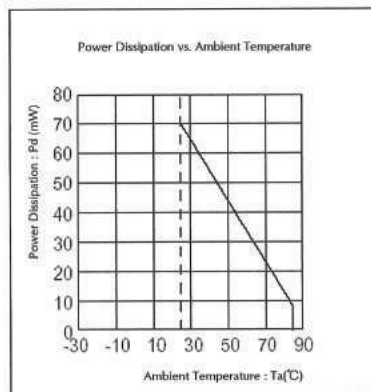
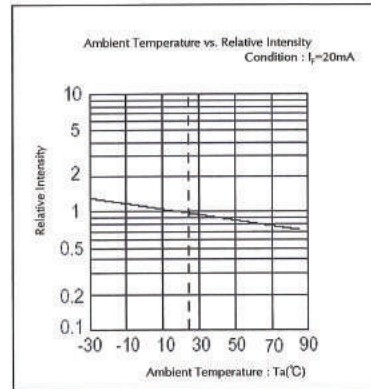
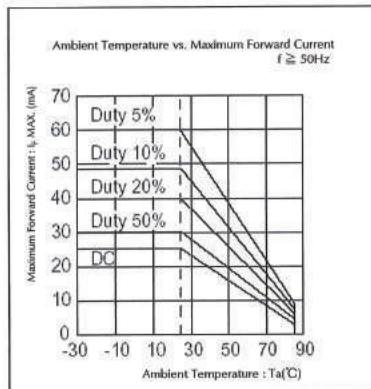
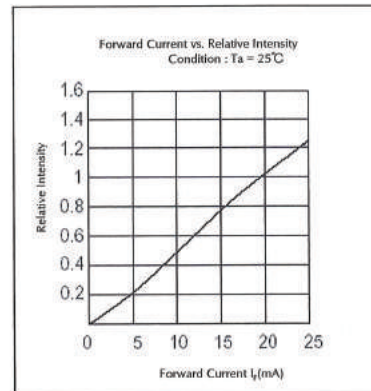
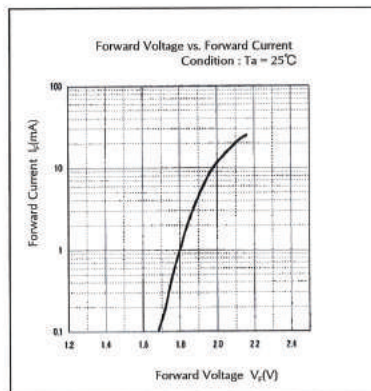
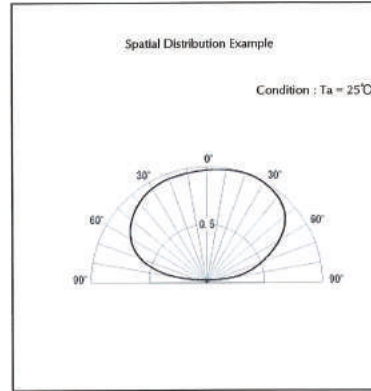
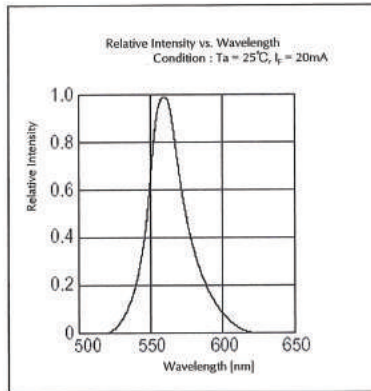

# Product Specifications

## 7012X1

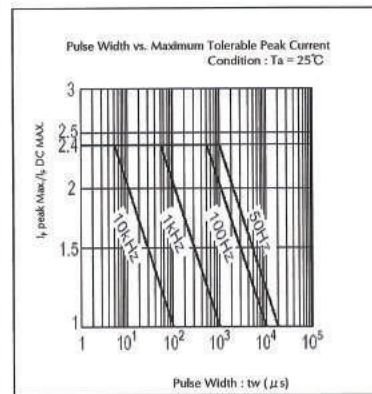
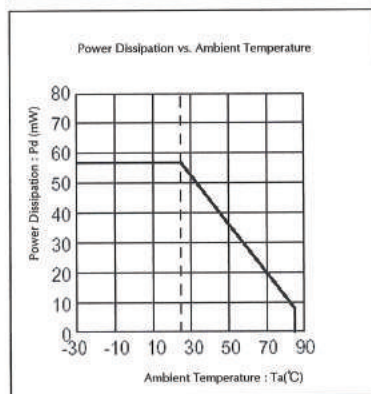
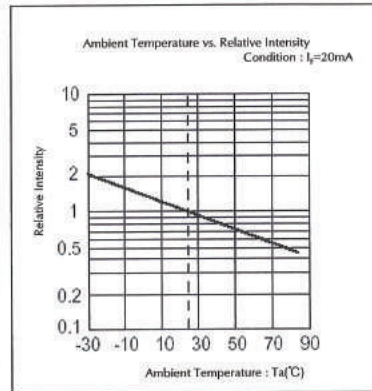
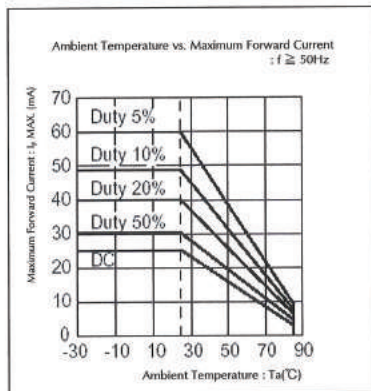
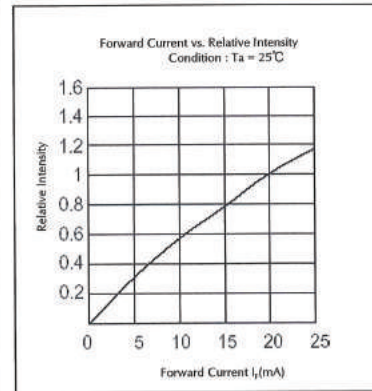
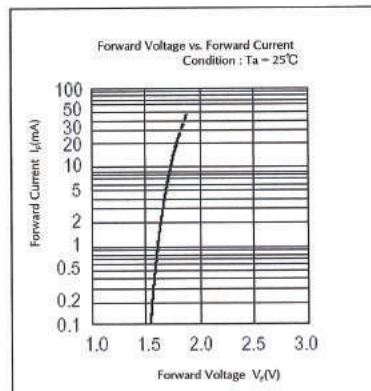
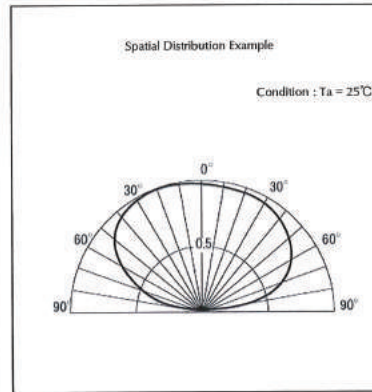
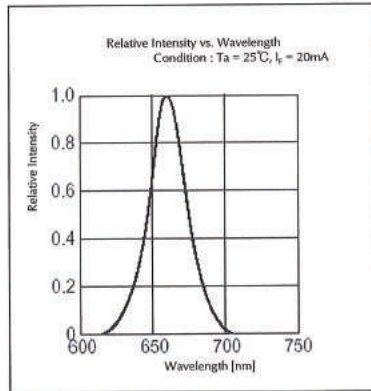

## Recommended Reflow Soldering Profile

Please follow these handling precautions to prevent damage to the chip and ensure its reliability.

### 1. Soldering conditions:

- Soldering iron: Temperature at tip of iron: 280°C max. (30W max.)  
Soldering time: 3 sec. max.
- Dip soldering: Preheating: 120 ~ 150°C max. (resin surface temp.)  
60 ~ 120 sec. max. Bath temperature: 260°C max. Dipping Time: 5 sec. max.
- Reflow Soldering:

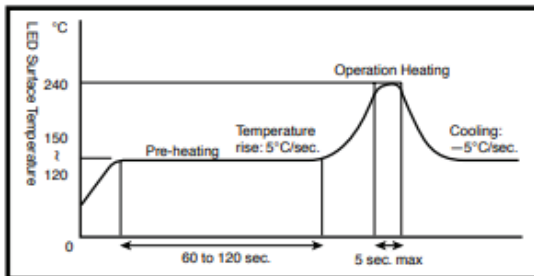

### 2. Cleaning:

- If cleaning is required, use the following solutions for less than 1 minute, at less than 40°C.
- Appropriate chemicals: Ethyl alcohol and isopropyl alcohol.
- Effect of ultrasonic cleaning on the LED resin body differs depending on such factors as the oscillator output, size of PCB and LED mounting method. The use of ultrasonic cleaning should be enforced at proper output after confirming there is no problem.

# Dimensions

7012X Series Solder Pad Geometry (Dimensions in mm)

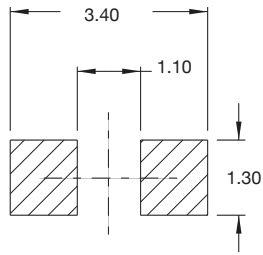

Direction of Feed

Reel Dimensions

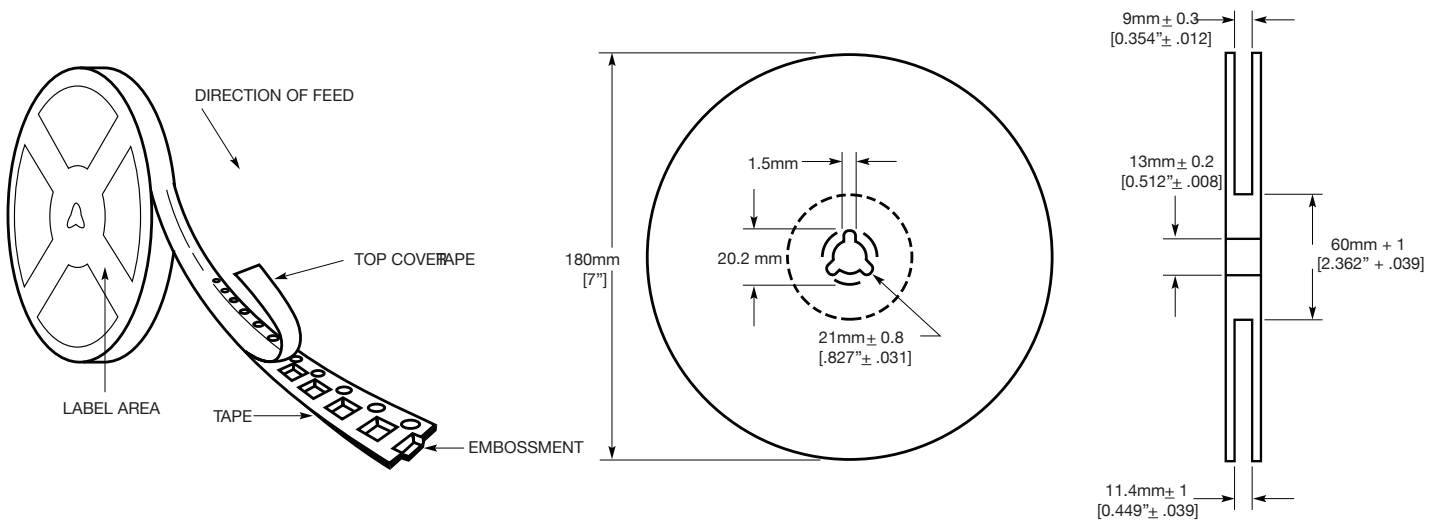

# Compliances and Approvals

