



February, 2016

Product Change Notice # 430-15086

Insulation Material Change of DF3 / DF13 Connector Series

1. Overview

This notification describes insulation material change of DF3 / DF13 series to a lower water-absorption material.

2. Reason for change

To improve mountability

3. Description of Change

Product Series	Description of Change	Before Change	After Change
DF3, DF13	Insulation case	PA46	PA9T
DF13	Absorption cap	(UL94V-0)	(UL94V-0)

4. Products Affected

* See attached P/N list "43015086_1_E.xls".

	Current Products	Products after the Change
DF3 Series with a boss	DF3Z-●P-2V(**) DF3Z-●P-2H(**)	DF3E-●P-2V(**) DF3E-●P-2H(**)
DF3 Series without a boss	DF3DZ-●P-2V(**) DF3DZ-●P-2H(**)	DF3EA-●P-2V(**) DF3EA-●P-2H(**)
DF13 Series with a boss	DF13-●DP-1.25V(**)	DF13E-●DP-1.25V(**)
DF13 Series without a boss	DF13A-●DP-1.25V(**)	DF13EA-●DP-1.25V(**)

5. Differences Resulting from the Change

(1) Change in product form

See attached Description of Change "43015086_2_E.xls".

(2) Difference in functions

We will guarantee the products after change have the same specification as existing parts.

1) Mating connectors can be used as usual after the material change of the products.

2) There is no material change on the mating connectors.

3) While products after change are RoHS compliant, chemical substances ratio have changed.
Please contact a Hirose sales representative concerning green procurement information.

(3) Discontinuation of products using moisture-proof packaging with silica gel

Since materials with a low water-absorbing property will be used after the change, we will discontinue the sales of products using the above packaging specification.

6. Schedule of Implementation

	Implemented on:
Last date for receiving orders for the current products	July 30, 2016
Start date for receiving orders for the new products	August 1, 2016
Last shipping date for the current products	January 31, 2017

End of Report

Attachment 1. List of Names of Products Before and After the Change

No.	Names of Products Affected by the Change		Product Name after Change		Remarks	
	Product Code	Product Name	Product Code	Product Name	Specification before change	Specification after change
1	CL543-1028-4-20	DF3Z-2P-2V(20)	CL543-0357-0-20	DF3E-2P-2V(20)	Tin plated Magazine packaging	Tin plated Magazine packaging
2	CL543-1029-7-20	DF3Z-3P-2V(20)	CL543-0358-0-20	DF3E-3P-2V(20)		
3	CL543-1030-6-20	DF3Z-4P-2V(20)	CL543-0359-0-20	DF3E-4P-2V(20)		
4	CL543-1031-9-20	DF3Z-5P-2V(20)	CL543-0360-0-20	DF3E-5P-2V(20)		
5	CL543-1032-1-20	DF3Z-6P-2V(20)	CL543-0361-0-20	DF3E-6P-2V(20)		
6	CL543-1033-4-20	DF3Z-7P-2V(20)	CL543-0362-0-20	DF3E-7P-2V(20)		
7	CL543-1034-7-20	DF3Z-8P-2V(20)	CL543-0363-0-20	DF3E-8P-2V(20)		
8	CL543-1035-0-20	DF3Z-9P-2V(20)	CL543-0364-0-20	DF3E-9P-2V(20)		
9	CL543-1036-2-20	DF3Z-10P-2V(20)	CL543-0365-0-20	DF3E-10P-2V(20)		
10	CL543-1038-8-20	DF3Z-12P-2V(20)	CL543-0367-0-20	DF3E-12P-2V(20)		
11	CL543-1056-0-20	DF3DZ-2P-2V(20)	CL543-0315-0-20	DF3EA-2P-2V(20)		
12	CL543-1058-5-20	DF3DZ-4P-2V(20)	CL543-0317-0-20	DF3EA-4P-2V(20)		
13	CL543-1060-7-20	DF3DZ-6P-2V(20)	CL543-0319-0-20	DF3EA-6P-2V(20)		
14	CL543-1061-0-20	DF3DZ-7P-2V(20)	CL543-0320-0-20	DF3EA-7P-2V(20)		
15	CL543-1042-5-20	DF3Z-2P-2H(20)	CL543-0343-0-20	DF3E-2P-2H(20)		
16	CL543-1043-8-20	DF3Z-3P-2H(20)	CL543-0344-0-20	DF3E-3P-2H(20)		
17	CL543-1044-0-20	DF3Z-4P-2H(20)	CL543-0345-0-20	DF3E-4P-2H(20)		
18	CL543-1045-3-20	DF3Z-5P-2H(20)	CL543-0346-0-20	DF3E-5P-2H(20)		
19	CL543-1046-6-20	DF3Z-6P-2H(20)	CL543-0347-0-20	DF3E-6P-2H(20)		
20	CL543-1047-9-20	DF3Z-7P-2H(20)	CL543-0348-0-20	DF3E-7P-2H(20)		
21	CL543-1050-3-20	DF3Z-10P-2H(20)	CL543-0351-0-20	DF3E-10P-2H(20)		
22	CL543-1054-4-20	DF3Z-14P-2H(20)	CL543-0355-0-20	DF3E-14P-2H(20)		
23	CL543-1070-0-20	DF3DZ-2P-2H(20)	CL543-0329-0-20	DF3EA-2P-2H(20)		
24	CL543-1071-3-20	DF3DZ-3P-2H(20)	CL543-0330-0-20	DF3EA-3P-2H(20)		
25	CL543-1072-6-20	DF3DZ-4P-2H(20)	CL543-0331-0-20	DF3EA-4P-2H(20)		
26	CL543-1028-4-21	DF3Z-2P-2V(21)	CL543-0357-0-21	DF3E-2P-2V(21)		
27	CL543-1029-7-21	DF3Z-3P-2V(21)	CL543-0358-0-21	DF3E-3P-2V(21)		
28	CL543-1030-6-21	DF3Z-4P-2V(21)	CL543-0359-0-21	DF3E-4P-2V(21)		
29	CL543-1031-9-21	DF3Z-5P-2V(21)	CL543-0360-0-21	DF3E-5P-2V(21)		
30	CL543-1032-1-21	DF3Z-6P-2V(21)	CL543-0361-0-21	DF3E-6P-2V(21)		
31	CL543-1034-7-21	DF3Z-8P-2V(21)	CL543-0363-0-21	DF3E-8P-2V(21)		
32	CL543-1036-2-21	DF3Z-10P-2V(21)	CL543-0365-0-21	DF3E-10P-2V(21)		
33	CL543-1037-5-21	DF3Z-11P-2V(21)	CL543-0366-0-21	DF3E-11P-2V(21)		
34	CL543-1056-0-21	DF3DZ-2P-2V(21)	CL543-0315-0-21	DF3EA-2P-2V(21)		
35	CL543-1057-2-21	DF3DZ-3P-2V(21)	CL543-0316-0-21	DF3EA-3P-2V(21)		
36	CL543-1058-5-21	DF3DZ-4P-2V(21)	CL543-0317-0-21	DF3EA-4P-2V(21)		
37	CL543-1059-8-21	DF3DZ-5P-2V(21)	CL543-0318-0-21	DF3EA-5P-2V(21)		
38	CL543-1060-7-21	DF3DZ-6P-2V(21)	CL543-0319-0-21	DF3EA-6P-2V(21)		
39	CL543-1061-0-21	DF3DZ-7P-2V(21)	CL543-0320-0-21	DF3EA-7P-2V(21)		
40	CL543-1062-2-21	DF3DZ-8P-2V(21)	CL543-0321-0-21	DF3EA-8P-2V(21)		
41	CL543-1063-5-21	DF3DZ-9P-2V(21)	CL543-0322-0-21	DF3EA-9P-2V(21)		
42	CL543-1064-8-21	DF3DZ-10P-2V(21)	CL543-0323-0-21	DF3EA-10P-2V(21)		
43	CL543-1065-0-21	DF3DZ-11P-2V(21)	CL543-0324-0-21	DF3EA-11P-2V(21)		
44	CL543-1066-3-21	DF3DZ-12P-2V(21)	CL543-0325-0-21	DF3EA-12P-2V(21)		
45	CL543-1067-6-21	DF3DZ-13P-2V(21)	CL543-0326-0-21	DF3EA-13P-2V(21)		
46	CL543-1068-9-21	DF3DZ-14P-2V(21)	CL543-0327-0-21	DF3EA-14P-2V(21)		
47	CL543-1069-1-21	DF3DZ-15P-2V(21)	CL543-0328-0-21	DF3EA-15P-2V(21)		
48	CL543-1042-5-21	DF3Z-2P-2H(21)	CL543-0343-0-21	DF3E-2P-2H(21)		
49	CL543-1043-8-21	DF3Z-3P-2H(21)	CL543-0344-0-21	DF3E-3P-2H(21)		
50	CL543-1044-0-21	DF3Z-4P-2H(21)	CL543-0345-0-21	DF3E-4P-2H(21)		
51	CL543-1046-6-21	DF3Z-6P-2H(21)	CL543-0347-0-21	DF3E-6P-2H(21)		
52	CL543-1047-9-21	DF3Z-7P-2H(21)	CL543-0348-0-21	DF3E-7P-2H(21)		
53	CL543-1048-1-21	DF3Z-8P-2H(21)	CL543-0349-0-21	DF3E-8P-2H(21)		
54	CL543-1050-3-21	DF3Z-10P-2H(21)	CL543-0351-0-21	DF3E-10P-2H(21)		
55	CL543-1070-0-21	DF3DZ-2P-2H(21)	CL543-0329-0-21	DF3EA-2P-2H(21)		
56	CL543-1071-3-21	DF3DZ-3P-2H(21)	CL543-0330-0-21	DF3EA-3P-2H(21)		
57	CL543-1072-6-21	DF3DZ-4P-2H(21)	CL543-0331-0-21	DF3EA-4P-2H(21)		
58	CL543-1073-9-21	DF3DZ-5P-2H(21)	CL543-0332-0-21	DF3EA-5P-2H(21)		
59	CL543-1074-1-21	DF3DZ-6P-2H(21)	CL543-0333-0-21	DF3EA-6P-2H(21)		
60	CL543-1075-4-21	DF3DZ-7P-2H(21)	CL543-0334-0-21	DF3EA-7P-2H(21)		
61	CL543-1076-7-21	DF3DZ-8P-2H(21)	CL543-0335-0-21	DF3EA-8P-2H(21)		
62	CL543-1077-0-21	DF3DZ-9P-2H(21)	CL543-0336-0-21	DF3EA-9P-2H(21)		
63	CL543-1078-2-21	DF3DZ-10P-2H(21)	CL543-0337-0-21	DF3EA-10P-2H(21)		
64	CL543-1079-5-21	DF3DZ-11P-2H(21)	CL543-0338-0-21	DF3EA-11P-2H(21)		
65	CL543-1080-4-21	DF3DZ-12P-2H(21)	CL543-0339-0-21	DF3EA-12P-2H(21)		
66	CL543-1081-7-21	DF3DZ-13P-2H(21)	CL543-0340-0-21	DF3EA-13P-2H(21)		
67	CL543-1082-0-21	DF3DZ-14P-2H(21)	CL543-0341-0-21	DF3EA-14P-2H(21)		
68	CL543-1083-2-21	DF3DZ-15P-2H(21)	CL543-0342-0-21	DF3EA-15P-2H(21)		

Attachment 1. List of Names of Products Before and After the Change

No.	Names of Products Affected by the Change		Product Name after Change		Remarks	
	Product Code	Product Name	Product Code	Product Name	Specification before change	Specification after change
69	CL543-1028-4-50	DF3Z-2P-2V(50)	CL543-0357-0-50	DF3E-2P-2V(50)	Gold plated Magazine packaging	Gold plated Magazine packaging
70	CL543-1029-7-50	DF3Z-3P-2V(50)	CL543-0358-0-50	DF3E-3P-2V(50)		
71	CL543-1030-6-50	DF3Z-4P-2V(50)	CL543-0359-0-50	DF3E-4P-2V(50)		
72	CL543-1031-9-50	DF3Z-5P-2V(50)	CL543-0360-0-50	DF3E-5P-2V(50)		
73	CL543-1032-1-50	DF3Z-6P-2V(50)	CL543-0361-0-50	DF3E-6P-2V(50)		
74	CL543-1033-4-50	DF3Z-7P-2V(50)	CL543-0362-0-50	DF3E-7P-2V(50)		
75	CL543-1034-7-50	DF3Z-8P-2V(50)	CL543-0363-0-50	DF3E-8P-2V(50)		
76	CL543-1036-2-50	DF3Z-10P-2V(50)	CL543-0365-0-50	DF3E-10P-2V(50)		
77	CL543-1038-8-50	DF3Z-12P-2V(50)	CL543-0367-0-50	DF3E-12P-2V(50)		
78	CL543-1041-2-50	DF3Z-15P-2V(50)	CL543-0370-0-50	DF3E-15P-2V(50)		
79	CL543-1056-0-50	DF3DZ-2P-2V(50)	CL543-0315-0-50	DF3EA-2P-2V(50)		
80	CL543-1057-2-50	DF3DZ-3P-2V(50)	CL543-0316-0-50	DF3EA-3P-2V(50)		
81	CL543-1060-7-50	DF3DZ-6P-2V(50)	CL543-0319-0-50	DF3EA-6P-2V(50)		
82	CL543-1042-5-50	DF3Z-2P-2H(50)	CL543-0343-0-50	DF3E-2P-2H(50)		
83	CL543-1043-8-50	DF3Z-3P-2H(50)	CL543-0344-0-50	DF3E-3P-2H(50)		
84	CL543-1044-0-50	DF3Z-4P-2H(50)	CL543-0345-0-50	DF3E-4P-2H(50)		
85	CL543-1045-3-50	DF3Z-5P-2H(50)	CL543-0346-0-50	DF3E-5P-2H(50)		
86	CL543-1046-6-50	DF3Z-6P-2H(50)	CL543-0347-0-50	DF3E-6P-2H(50)		
87	CL543-1048-1-50	DF3Z-8P-2H(50)	CL543-0349-0-50	DF3E-8P-2H(50)		
88	CL543-1050-3-50	DF3Z-10P-2H(50)	CL543-0351-0-50	DF3E-10P-2H(50)		
89	CL543-1072-6-50	DF3DZ-4P-2H(50)	CL543-0331-0-50	DF3EA-4P-2H(50)		
90	CL543-1076-7-50	DF3DZ-8P-2H(50)	CL543-0335-0-50	DF3EA-8P-2H(50)		
91	CL543-1081-7-50	DF3DZ-13P-2H(50)	CL543-0340-0-50	DF3EA-13P-2H(50)		
92	CL543-1083-2-50	DF3DZ-15P-2H(50)	CL543-0342-0-50	DF3EA-15P-2H(50)		
93	CL543-1028-4-51	DF3Z-2P-2V(51)	CL543-0357-0-51	DF3E-2P-2V(51)		
94	CL543-1029-7-51	DF3Z-3P-2V(51)	CL543-0358-0-51	DF3E-3P-2V(51)		
95	CL543-1030-6-51	DF3Z-4P-2V(51)	CL543-0359-0-51	DF3E-4P-2V(51)		
96	CL543-1031-9-51	DF3Z-5P-2V(51)	CL543-0360-0-51	DF3E-5P-2V(51)		
97	CL543-1032-1-51	DF3Z-6P-2V(51)	CL543-0361-0-51	DF3E-6P-2V(51)		
98	CL543-1033-4-51	DF3Z-7P-2V(51)	CL543-0362-0-51	DF3E-7P-2V(51)		
99	CL543-1034-7-51	DF3Z-8P-2V(51)	CL543-0363-0-51	DF3E-8P-2V(51)		
100	CL543-1036-2-51	DF3Z-10P-2V(51)	CL543-0365-0-51	DF3E-10P-2V(51)		
101	CL543-1056-0-51	DF3DZ-2P-2V(51)	CL543-0315-0-51	DF3EA-2P-2V(51)		
102	CL543-1057-2-51	DF3DZ-3P-2V(51)	CL543-0316-0-51	DF3EA-3P-2V(51)		
103	CL543-1058-5-51	DF3DZ-4P-2V(51)	CL543-0317-0-51	DF3EA-4P-2V(51)		
104	CL543-1059-8-51	DF3DZ-5P-2V(51)	CL543-0318-0-51	DF3EA-5P-2V(51)		
105	CL543-1060-7-51	DF3DZ-6P-2V(51)	CL543-0319-0-51	DF3EA-6P-2V(51)		
106	CL543-1061-0-51	DF3DZ-7P-2V(51)	CL543-0320-0-51	DF3EA-7P-2V(51)		
107	CL543-1062-2-51	DF3DZ-8P-2V(51)	CL543-0321-0-51	DF3EA-8P-2V(51)		
108	CL543-1063-5-51	DF3DZ-9P-2V(51)	CL543-0322-0-51	DF3EA-9P-2V(51)		
109	CL543-1064-8-51	DF3DZ-10P-2V(51)	CL543-0323-0-51	DF3EA-10P-2V(51)		
110	CL543-1065-0-51	DF3DZ-11P-2V(51)	CL543-0324-0-51	DF3EA-11P-2V(51)		
111	CL543-1066-3-51	DF3DZ-12P-2V(51)	CL543-0325-0-51	DF3EA-12P-2V(51)		
112	CL543-1067-6-51	DF3DZ-13P-2V(51)	CL543-0326-0-51	DF3EA-13P-2V(51)		
113	CL543-1068-9-51	DF3DZ-14P-2V(51)	CL543-0327-0-51	DF3EA-14P-2V(51)		
114	CL543-1069-1-51	DF3DZ-15P-2V(51)	CL543-0328-0-51	DF3EA-15P-2V(51)		
115	CL543-1042-5-51	DF3Z-2P-2H(51)	CL543-0343-0-51	DF3E-2P-2H(51)		
116	CL543-1044-0-51	DF3Z-4P-2H(51)	CL543-0345-0-51	DF3E-4P-2H(51)		
117	CL543-1046-6-51	DF3Z-6P-2H(51)	CL543-0347-0-51	DF3E-6P-2H(51)		
118	CL543-1047-9-51	DF3Z-7P-2H(51)	CL543-0348-0-51	DF3E-7P-2H(51)		
119	CL543-1055-7-51	DF3Z-15P-2H(51)	CL543-0356-0-51	DF3E-15P-2H(51)		
120	CL543-1070-0-51	DF3DZ-2P-2H(51)	CL543-0329-0-51	DF3EA-2P-2H(51)		
121	CL543-1071-3-51	DF3DZ-3P-2H(51)	CL543-0330-0-51	DF3EA-3P-2H(51)		
122	CL543-1072-6-51	DF3DZ-4P-2H(51)	CL543-0331-0-51	DF3EA-4P-2H(51)		
123	CL543-1073-9-51	DF3DZ-5P-2H(51)	CL543-0332-0-51	DF3EA-5P-2H(51)		
124	CL543-1074-1-51	DF3DZ-6P-2H(51)	CL543-0333-0-51	DF3EA-6P-2H(51)		
125	CL543-1075-4-51	DF3DZ-7P-2H(51)	CL543-0334-0-51	DF3EA-7P-2H(51)		
126	CL543-1076-7-51	DF3DZ-8P-2H(51)	CL543-0335-0-51	DF3EA-8P-2H(51)		
127	CL543-1077-0-51	DF3DZ-9P-2H(51)	CL543-0336-0-51	DF3EA-9P-2H(51)		
128	CL543-1078-2-51	DF3DZ-10P-2H(51)	CL543-0337-0-51	DF3EA-10P-2H(51)		
129	CL543-1079-5-51	DF3DZ-11P-2H(51)	CL543-0338-0-51	DF3EA-11P-2H(51)		
130	CL543-1080-4-51	DF3DZ-12P-2H(51)	CL543-0339-0-51	DF3EA-12P-2H(51)		
131	CL543-1081-7-51	DF3DZ-13P-2H(51)	CL543-0340-0-51	DF3EA-13P-2H(51)		
132	CL543-1082-0-51	DF3DZ-14P-2H(51)	CL543-0341-0-51	DF3EA-14P-2H(51)		
133	CL543-1083-2-51	DF3DZ-15P-2H(51)	CL543-0342-0-51	DF3EA-15P-2H(51)		
134	CL543-1071-3-59	DF3DZ-3P-2H(59)	CL543-0330-0-59	DF3EA-3P-2H(59)	Gold plated Pin extraction Embossed tape packaging (moisture-proof)	Gold plated Pin extraction Embossed tape packaging
135	CL543-1030-6-72	DF3Z-4P-2V(72)	CL543-0359-0-72	DF3E-4P-2V(72)	Tin plated Absorption tape attached Embossed tape packaging (moisture-proof)	Tin plated Absorption tape attached Embossed tape packaging
136	CL543-1031-9-72	DF3Z-5P-2V(72)	CL543-0360-0-72	DF3E-5P-2V(72)		

Attachment 1. List of Names of Products Before and After the Change

No.	Names of Products Affected by the Change		Product Name after Change		Remarks	
	Product Code	Product Name	Product Code	Product Name	Specification before change	Specification after change
137	CL543-1056-0-73	DF3DZ-2P-2V(73)	CL543-0315-0-51	DF3EA-2P-2V(51)	Gold plated Labeled Embossed tape packaging (Aluminum moisture-proof packaging)	Gold plated Embossed tape packaging
138	CL543-1058-5-73	DF3DZ-4P-2V(73)	CL543-0317-0-51	DF3EA-4P-2V(51)		
139	CL543-1060-7-73	DF3DZ-6P-2V(73)	CL543-0319-0-51	DF3EA-6P-2V(51)		
140	CL543-1064-8-73	DF3DZ-10P-2V(73)	CL543-0323-0-51	DF3EA-10P-2V(51)		
141	CL543-1066-3-73	DF3DZ-12P-2V(73)	CL543-0325-0-51	DF3EA-12P-2V(51)		
142	CL543-1069-1-73	DF3DZ-15P-2V(73)	CL543-0328-0-51	DF3EA-15P-2V(51)		
143	CL543-1070-0-73	DF3DZ-2P-2H(73)	CL543-0329-0-51	DF3EA-2P-2H(51)		
144	CL543-1074-1-73	DF3DZ-6P-2H(73)	CL543-0333-0-51	DF3EA-6P-2H(51)	Tin plated Labeled Embossed tape packaging (Aluminum moisture-proof packaging)	Tin plated Embossed tape packaging
145	CL543-1042-5-74	DF3Z-2P-2H(74)	CL543-0343-0-21	DF3E-2P-2H(21)		
146	CL543-1043-8-74	DF3Z-3P-2H(74)	CL543-0344-0-21	DF3E-3P-2H(21)	Tin plated Embossed tape packaging (Aluminum moisture-proof packaging)	Tin plated Embossed tape packaging
147	CL543-1056-0-75	DF3DZ-2P-2V(75)	CL543-0315-0-21	DF3EA-2P-2V(21)		
148	CL543-1057-2-75	DF3DZ-3P-2V(75)	CL543-0316-0-21	DF3EA-3P-2V(21)		
149	CL543-1058-5-75	DF3DZ-4P-2V(75)	CL543-0317-0-21	DF3EA-4P-2V(21)		
150	CL543-1060-7-75	DF3DZ-6P-2V(75)	CL543-0319-0-21	DF3EA-6P-2V(21)		
151	CL543-1062-2-75	DF3DZ-8P-2V(75)	CL543-0321-0-21	DF3EA-8P-2V(21)		
152	CL543-1070-0-75	DF3DZ-2P-2H(75)	CL543-0329-0-21	DF3EA-2P-2H(21)		
153	CL543-1072-6-75	DF3DZ-4P-2H(75)	CL543-0331-0-21	DF3EA-4P-2H(21)	Gold plated Embossed tape packaging (Aluminum moisture-proof packaging)	Gold plated Embossed tape packaging
154	CL543-1074-1-75	DF3DZ-6P-2H(75)	CL543-0333-0-21	DF3EA-6P-2H(21)		
155	CL543-1076-7-75	DF3DZ-8P-2H(75)	CL543-0335-0-21	DF3EA-8P-2H(21)		
156	CL543-1056-0-76	DF3DZ-2P-2V(76)	CL543-0315-0-51	DF3EA-2P-2V(51)	Gold plated Embossed tape packaging (Aluminum moisture-proof packaging)	Gold plated Embossed tape packaging
157	CL543-1059-8-76	DF3DZ-5P-2V(76)	CL543-0318-0-51	DF3EA-5P-2V(51)		
158	CL543-1071-3-76	DF3DZ-3P-2H(76)	CL543-0330-0-51	DF3EA-3P-2H(51)		
159	CL543-1073-9-76	DF3DZ-5P-2H(76)	CL543-0332-0-51	DF3EA-5P-2H(51)		
160	CL543-1058-5-77	DF3DZ-4P-2V(77)	CL543-0317-0-77	DF3EA-4P-2V(77)	Thick gold plated Embossed tape packaging (moisture-proof)	Thick gold plated Embossed tape packaging
161	CL543-1044-0-78	DF3Z-4P-2H(78)	CL543-0345-0-78	DF3E-4P-2H(78)	Gold plated Labeled Embossed tape packaging (moisture-proof)	Gold plated Labeled Embossed tape packaging
162	CL543-1034-7-94	DF3Z-8P-2V(94)	CL543-0363-0-94	DF3E-8P-2V(94)	Tin plated Insertion/extraction force reinforced Embossed tape packaging (moisture-proof)	Tin plated Insertion/extraction force reinforced Embossed tape packaging
163	CL543-1062-2-94	DF3DZ-8P-2V(94)	CL543-0321-0-94	DF3EA-8P-2V(94)		
164	CL543-1076-7-94	DF3DZ-8P-2H(94)	CL543-0335-0-94	DF3EA-8P-2H(94)		
165	CL543-1062-2-95	DF3DZ-8P-2V(95)	CL543-0321-0-95	DF3EA-8P-2V(95)	Gold plated Insertion/extraction force reinforced Embossed tape packaging (moisture-proof)	Gold plated Insertion/extraction force reinforced Embossed tape packaging
166	CL536-0510-8-25	DF13-10DP-1.25V(25)	CL536-0566-0-25	DF13E-10DP-1.25V(25)	Tin-copper plated Magazine packaging	Tin-copper plated Magazine packaging
167	CL536-0515-1-25	DF13-20DP-1.25V(25)	CL536-0567-0-25	DF13E-20DP-1.25V(25)		
168	CL536-0605-2-25	DF13A-20DP-1.25V(25)	CL536-0571-0-25	DF13EA-20DP-1.25V(25)	Tin-copper plated Embossed tape packaging (moisture-proof)	Tin-copper plated Embossed tape packaging
169	CL536-0510-8-95	DF13-10DP-1.25V(95)	CL536-0566-0-21	DF13E-10DP-1.25V(21)		
170	CL536-0515-1-95	DF13-20DP-1.25V(95)	CL536-0567-0-21	DF13E-20DP-1.25V(21)		
171	CL536-0520-1-95	DF13-30DP-1.25V(95)	CL536-0568-0-21	DF13E-30DP-1.25V(21)		
172	CL536-0600-9-95	DF13A-10DP-1.25V(95)	CL536-0570-0-21	DF13EA-10DP-1.25V(21)		
173	CL536-0605-2-95	DF13A-20DP-1.25V(95)	CL536-0571-0-21	DF13EA-20DP-1.25V(21)		
174	CL536-0610-2-95	DF13A-30DP-1.25V(95)	CL536-0572-0-21	DF13EA-30DP-1.25V(21)		
175	CL536-0615-6-95	DF13A-40DP-1.25V(95)	CL536-0573-0-21	DF13EA-40DP-1.25V(21)	Gold plated Magazine packaging	Gold plated Magazine packaging
176	CL536-0510-8-55	DF13-10DP-1.25V(55)	CL536-0566-0-55	DF13E-10DP-1.25V(55)		
177	CL536-0515-1-55	DF13-20DP-1.25V(55)	CL536-0567-0-55	DF13E-20DP-1.25V(55)		
178	CL536-0520-1-55	DF13-30DP-1.25V(55)	CL536-0568-0-55	DF13E-30DP-1.25V(55)		
179	CL536-0525-5-55	DF13-40DP-1.25V(55)	CL536-0569-0-55	DF13E-40DP-1.25V(55)		
180	CL536-0600-9-55	DF13A-10DP-1.25V(55)	CL536-0570-0-55	DF13EA-10DP-1.25V(55)	Gold plated Embossed tape packaging (moisture-proof)	Gold plated Embossed tape packaging
181	CL536-0605-2-55	DF13A-20DP-1.25V(55)	CL536-0571-0-55	DF13EA-20DP-1.25V(55)		
182	CL536-0610-2-55	DF13A-30DP-1.25V(55)	CL536-0572-0-55	DF13EA-30DP-1.25V(55)		
183	CL536-0615-6-55	DF13A-40DP-1.25V(55)	CL536-0573-0-55	DF13EA-40DP-1.25V(55)		
184	CL536-0510-8-91	DF13-10DP-1.25V(91)	CL536-0566-0-51	DF13E-10DP-1.25V(51)		
185	CL536-0515-1-91	DF13-20DP-1.25V(91)	CL536-0567-0-51	DF13E-20DP-1.25V(51)		
186	CL536-0520-1-91	DF13-30DP-1.25V(91)	CL536-0568-0-51	DF13E-30DP-1.25V(51)		
187	CL536-0525-5-91	DF13-40DP-1.25V(91)	CL536-0569-0-51	DF13E-40DP-1.25V(51)		
188	CL536-0600-9-91	DF13A-10DP-1.25V(91)	CL536-0570-0-51	DF13EA-10DP-1.25V(51)		
189	CL536-0605-2-91	DF13A-20DP-1.25V(91)	CL536-0571-0-51	DF13EA-20DP-1.25V(51)		
190	CL536-0610-2-91	DF13A-30DP-1.25V(91)	CL536-0572-0-51	DF13EA-30DP-1.25V(51)		
191	CL536-0615-6-91	DF13A-40DP-1.25V(91)	CL536-0573-0-51	DF13EA-40DP-1.25V(51)	Gold plated Plastic reel Embossed tape packaging (moisture-proof)	Gold plated Plastic reel Embossed tape packaging
192	CL536-0520-1-82	DF13-30DP-1.25V(82)	CL536-0568-0-82	DF13E-30DP-1.25V(82)		
193	CL536-0525-5-82	DF13-40DP-1.25V(82)	CL536-0569-0-82	DF13E-40DP-1.25V(82)		
194	CL536-0610-2-82	DF13A-30DP-1.25V(82)	CL536-0572-0-82	DF13EA-30DP-1.25V(82)		
195	CL536-0615-6-82	DF13A-40DP-1.25V(82)	CL536-0573-0-82	DF13EA-40DP-1.25V(82)		
196	CL536-0600-9-82	DF13A-10DP-1.25V(82)	CL536-0570-0-82	DF13EA-10DP-1.25V(82)		
197	CL536-0605-2-82	DF13A-20DP-1.25V(82)	CL536-0571-0-82	DF13EA-20DP-1.25V(82)		
198	CL536-0605-2-93	DF13A-20DP-1.25V(93)	CL536-0571-0-93	DF13EA-20DP-1.25V(93)		

■ Description of form change of DF3 series connectors

1. Addition of round shapes and wider opening will make housing's break-resistant property against load at the time of tilted insertion even.

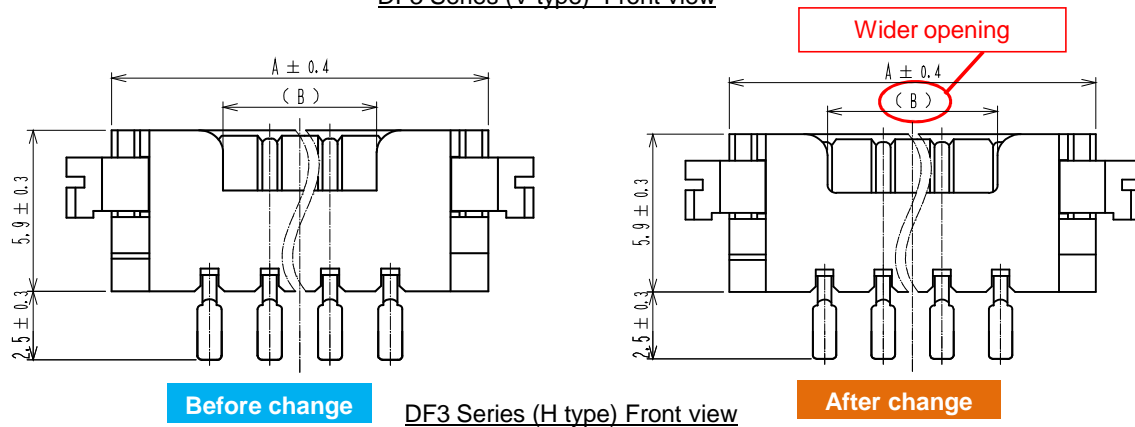
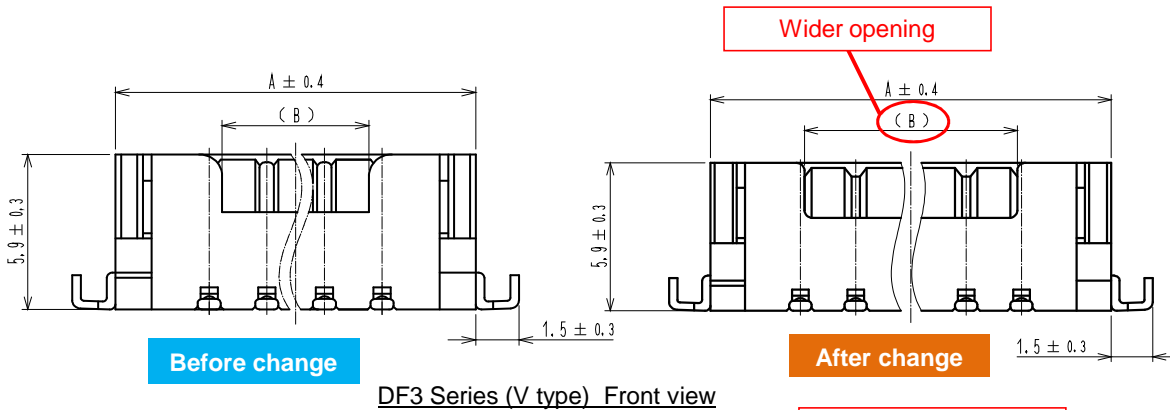

Unit: mm

# of pins	Before change		After change	
	Dimension A	Dimension B	Dimension A	Dimension B
2	6.5	1.05	6.5	1.75
3	8.5	3.05	8.5	3.75
4	10.5	5.05	10.5	5.75
5	12.5	7.05	12.5	7.75
6	14.5	9.05	14.5	9.75
7	16.5	11.05	16.5	11.75
8	18.5	13.05	18.5	13.75
9	20.5	15.05	20.5	15.75
10	22.5	17.05	22.5	17.75
11	24.5	19.05	24.5	19.75
12	26.5	21.05	26.5	21.75
13	28.5	23.05	28.5	23.75
14	30.5	25.05	30.5	25.75
15	32.5	27.05	32.5	27.75

2. We will achieve molding stability by adding lightening parts to make the thickness of the resin more even. There will be no change in the recommended PCB pattern drawing.

< DF3 Series (V type) >

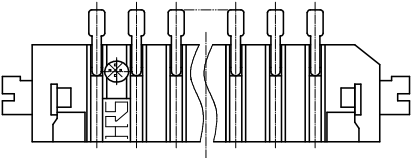
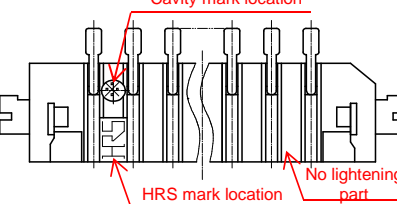
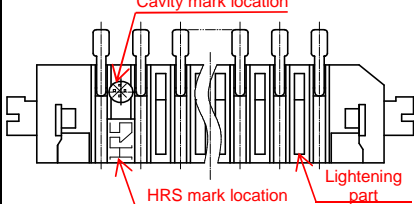
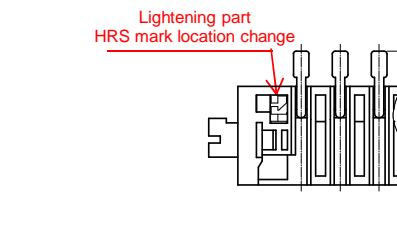
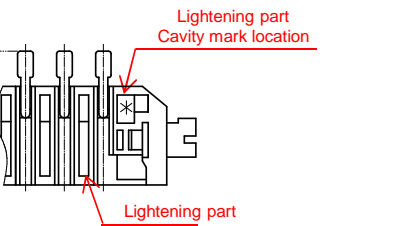
	2 to 6 pins	7 to 10 pins	11 to 15 pins
Before change	 <p>DF3 Series (V type) bottom face</p>		
After change			
Difference	No difference	<ul style="list-style-type: none"> • Lightening parts added • HRS/cavity mark location change 	<ul style="list-style-type: none"> • Lightening parts added • HRS/cavity mark location change

< DF3 series (H type) >

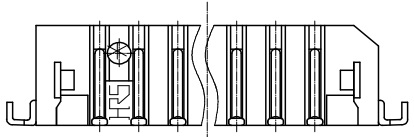
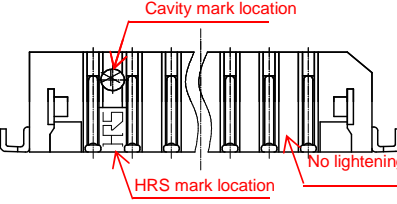
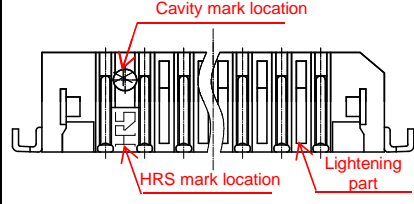
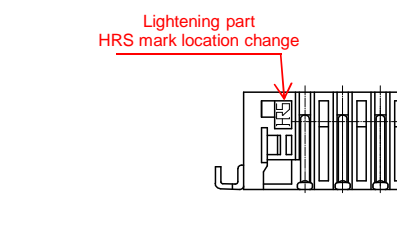
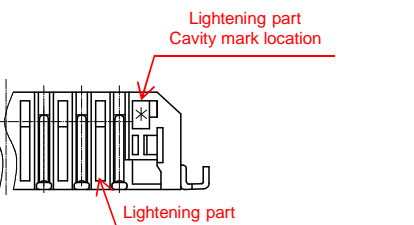
	2 to 6 pins	7 to 10 pins	11 to 15 pins
Before change	 <p>DF3 series (H type) back face</p>		
After change			
Difference	No difference	<ul style="list-style-type: none"> • Lightening parts added • HRS/cavity mark location change 	<ul style="list-style-type: none"> • Lightening parts added • HRS/cavity mark location change

■ Description of form change in DF13 series connectors

- We will change the form of the lock to improve operability at the time of extraction.

