



**Please note that Cypress is an Infineon Technologies Company.**

The document following this cover page is marked as “Cypress” document as this is the company that originally developed the product. Please note that Infineon will continue to offer the product to new and existing customers as part of the Infineon product portfolio.

**Continuity of document content**

The fact that Infineon offers the following product as part of the Infineon product portfolio does not lead to any changes to this document. Future revisions will occur when appropriate, and any changes will be set out on the document history page.

**Continuity of ordering part numbers**

Infineon continues to support existing part numbers. Please continue to use the ordering part numbers listed in the datasheet for ordering.

## 3ch DC/DC Converter IC for Automotive Cluster

S6BP501A/S6BP502A is a three channel output power management IC. This IC includes one high voltage buck DC/DC controller (DD3V), one buck DC/DC converter with built-in FETs (DD1V) and one boost DC/DC converter with built-in FETs (DD5V). Current mode architecture is used for fast load transient response. At no load, the input supply current is reduced to 15  $\mu$ A (Typ). It is possible to provide stable output voltage under an automotive cold cranking condition until the input voltage falls to 2.5V. This IC is suitable for power supply solutions of automotive and Industrial applications. Each output voltage can be adjusted by external resistors. Both DD1V and DD5V support the switching frequencies up to 2.4 MHz to allow use of small size inductors, which can reduce a part mounting area. To decrease EMI, this IC equips a SYNC function that synchronizes to an external clock signal and a spread spectrum clock generator (SSCG). When not inputting an external clock, it operates by an internal clock. The SSCG is valid both internal clock and external clock. Moreover, this IC has power good (PG) monitors for each output and a thermal-warning indicator.

### Features

- Wide input voltage range : 2.5V to 42V (DD3V)
- Adjustable output voltage with pairs of resistors
  - DD1V : 1.0V to 1.3V
  - DD3V : 3.2V to 3.4V
  - DD5V : 5.0V to 5.2V
- Switching frequency range (synchronizable to external clock by SYNC function)
  - DD1V, DD5V
    - Internal clock operation : 2.1 MHz (Typ)
    - External clock operation : 1.8 MHz to 2.4 MHz
  - DD3V (one-fifth-divided clock)
    - Internal clock operation : 420 kHz (Typ)
    - External clock operation : 360 kHz to 480 kHz
- Super-high efficiency by PFM operation (DD3V, DD5V : When fixing SYNC pin to a low level)
- Automatic PWM/PFM switching and fixed PWM operations are settable by SYNC pin (DD3V, DD5V)
- Operable on up to 100% duty (DD3V)
- Built-in phase compensators
- Built-in SSCG (spread spectrum clock generator)
- Synchronous rectification current mode architecture
- Shutdown current : 1  $\mu$ A (Typ)
- Quiescent current : 15  $\mu$ A (Typ)
- Load-independent soft-start
- Power good monitors for each output
  - OVD (over voltage detection)
  - UVD (under voltage detection)
- Enhanced protection functions
  - UVLO (under voltage lockout)
  - OVP (over voltage protection)
  - OCP (over current protection)
  - TSD (thermal shutdown)
  - TWI (thermal warning indicator)
- Wettable QFN-32 package : 5 mm  $\times$  5 mm
- AEC-Q100 compliant (Grade-2)

### Applications

- Instrument cluster
- Automotive applications
- Industrial applications

### Block Diagram

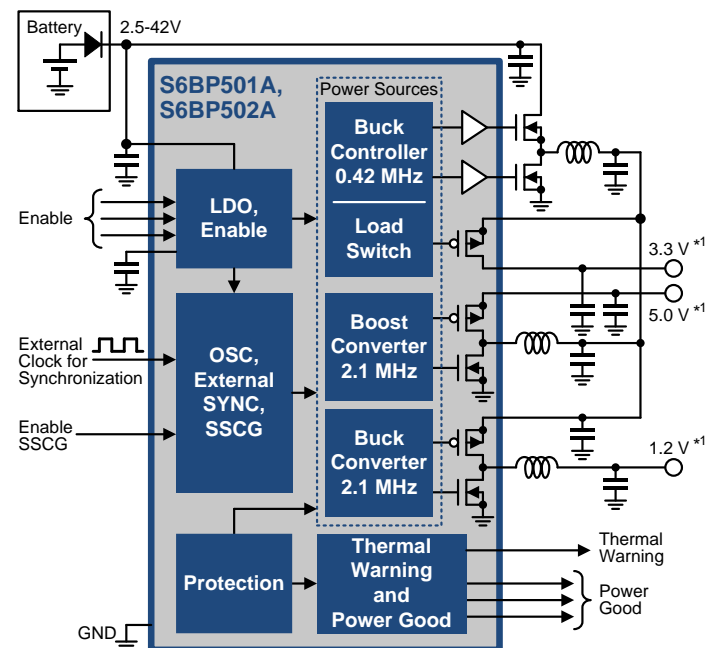

\*1: Output voltages are finely adjustable with external resistive dividers

## More Information

Cypress provides a wealth of data at [www.cypress.com/pmic](http://www.cypress.com/pmic) to help you to select the right PMIC device for your design, and to help you to quickly and effectively integrate the device into your design. Following is an abbreviated list for S6BP501A and S6BP502A:

- Overview: [Automotive PMIC Portfolio](#), [Automotive PMIC Roadmap](#)
- Product Selector:
  - [S6BP501A, S6BP502A](#):  
3ch Automotive PMIC for Instrument Cluster
- Application Notes: Cypress offers S6BP501A and S6BP502A application notes. Recommended application notes for getting started with S6BP501A and S6BP502A are:
  - [AN99435](#): Designing a Power Management System
  - [AN201006](#): Thermal Considerations and Parameters
- Evaluation Kit Operation Manual:
  - [S6SBP501A00VA1001, S6SBP502A00VA1001](#):  
Power block of automotive instrument cluster
- Related Products:
  - [S6BP201A, S6BP202A, S6BP203A](#):  
1ch Buck-Boost Automotive PMIC
  - [S6BP401A](#):  
6ch Automotive PMIC for ADAS

## Contents

<b>Features</b> .....	<b>1</b>
<b>Applications</b> .....	<b>1</b>
<b>Block Diagram</b> .....	<b>1</b>
<b>More Information</b> .....	<b>2</b>
<b>1. Product Lineup</b> .....	<b>4</b>
<b>2. Pin Assignment</b> .....	<b>4</b>
<b>3. Pin Descriptions</b> .....	<b>5</b>
<b>4. Architecture Block Diagram</b> .....	<b>7</b>
<b>5. Absolute Maximum Ratings</b> .....	<b>8</b>
<b>6. Recommended Operating Conditions</b> .....	<b>9</b>
<b>7. Electrical Characteristics</b> .....	<b>10</b>
<b>8. Functional Description</b> .....	<b>14</b>
8.1 Operation Sequence.....	14
8.2 Each Function Block.....	15
8.3 Output State and Protection Function Table.....	18
<b>9. Application Circuit Example and Parts List</b> .....	<b>19</b>
<b>10. Application Note</b> .....	<b>21</b>
10.1 Setting the Operation Conditions.....	21
<b>11. Reference Data</b> .....	<b>24</b>
<b>12. Usage Precaution</b> .....	<b>31</b>
<b>13. RoHS Compliance Information</b> .....	<b>31</b>
<b>14. Ordering Information</b> .....	<b>31</b>
<b>15. Package Dimensions</b> .....	<b>32</b>
<b>Document History</b> .....	<b>33</b>
<b>Sales, Solutions, and Legal Information</b> .....	<b>36</b>

## 1. Product Lineup

To order a product, select an item from the product lineup blow. For information on the ordering part number, please see "14. Ordering Information".

Product Name	S6BP501A	S6BP502A	
Pin count	32		
Power supply voltage range	2.5V to 42V		
Output voltage range	DD1V	1.0V to 1.3V	
	DD3V	3.2V to 3.4V	
	DD5V	5.0V to 5.2V	
Maximum output current	DD1V	1.4A	2.0A
	SW3V (*1)	1.6A	1.9A
	DD5V	1.3A	1.3A
Package	QFN-32 (VNG032)		

\*1: Load switch for DD3V. Each value is the maximum output current via SW3V.

## 2. Pin Assignment

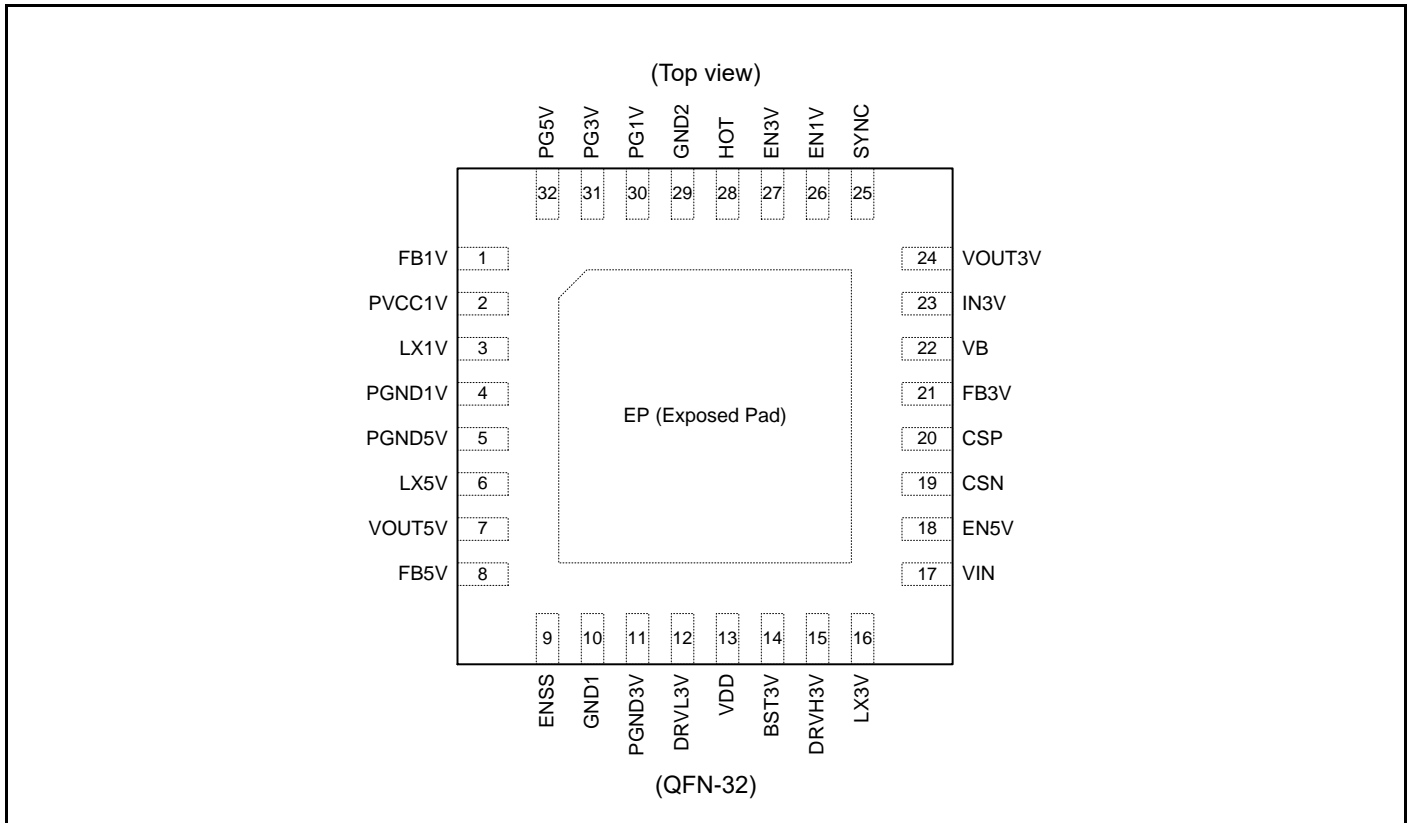

### 3. Pin Descriptions

**Table 3-1 Pin Descriptions**

Pin No.	Pin Name	I/O	Description
1	FB1V	I	Feedback pin for DD1V output voltage
2	PVCC1V	-	Power supply pin for DD1V
3	LX1V	O	Inductor connection pin for DD1V
4	PGND1V	-	Power ground pin for DD1V
5	PGND5V	-	Power ground pin for DD5V
6	LX5V	O	Inductor connection pin for DD5V
7	VOU5V	O	Voltage output pin for DD5V
8	FB5V	I	Feedback pin for DD5V output voltage
9	ENSS	I	Enable pin for SSCG (When not being used, connect this pin to ground pin. For the pin setting, see "Table 8-1 SSCG Pin Setting".)
10	GND1	-	Ground pin
11	PGND3V	-	Power ground for DD3V
12	DRVL3V	O	Low-side FET gate driver output pin for DD3V
13	VDD	I	Power supply pin for gate driver for DD3V
14	BST3V	I	Boost capacitor connection pin for DD3V
15	DRVH3V	O	High-side FET gate driver output pin for DD3V
16	LX3V	O	Inductor connection pin for DD3V
17	VIN	I	Power supply pin connecting battery
18	EN5V	I	Enable pin for DD3V and DD5V
19	CSN	I	Negative current sense pin
20	CSP	I	Positive current sense pin
21	FB3V	I	Feedback pin for DD3V output voltage
22	VB	O	Bias voltage output pin and power supply pin for logic Do NOT connect any loads to this pin
23	IN3V	I	Power supply pin for load switch (SW3V) and DD1V
24	VOU3V	O	Voltage output pin for DD3V via load switch (SW3V)
25	SYNC	I	External clock input / SYNC function setting pin (For the pin setting, see "Table 8-2 SYNC Pin Setting".)
26	EN1V	I	Enable pin for DD1V. Apply by connecting with EN3V.
27	EN3V	I	Enable pin for SW3V load switch (SW3V). Apply by connecting with EN1V.
28	HOT	O	Open drain type power good output pin for thermal warning indicator (When not being used, connect this pin to ground pin)
29	GND2	-	Ground pin
30	PG1V	O	Open drain type power good output pin for DD1V (When not being used, connect this pin to ground pin)
31	PG3V	O	Open drain type power good output pin for DD3V (When not being used, connect this pin to ground pin)
32	PG5V	O	Open drain type power good output pin for DD5V (When not being used, connect this pin to ground pin)

**Figure 3-1 I/O Pin Equivalent Circuit Diagram**

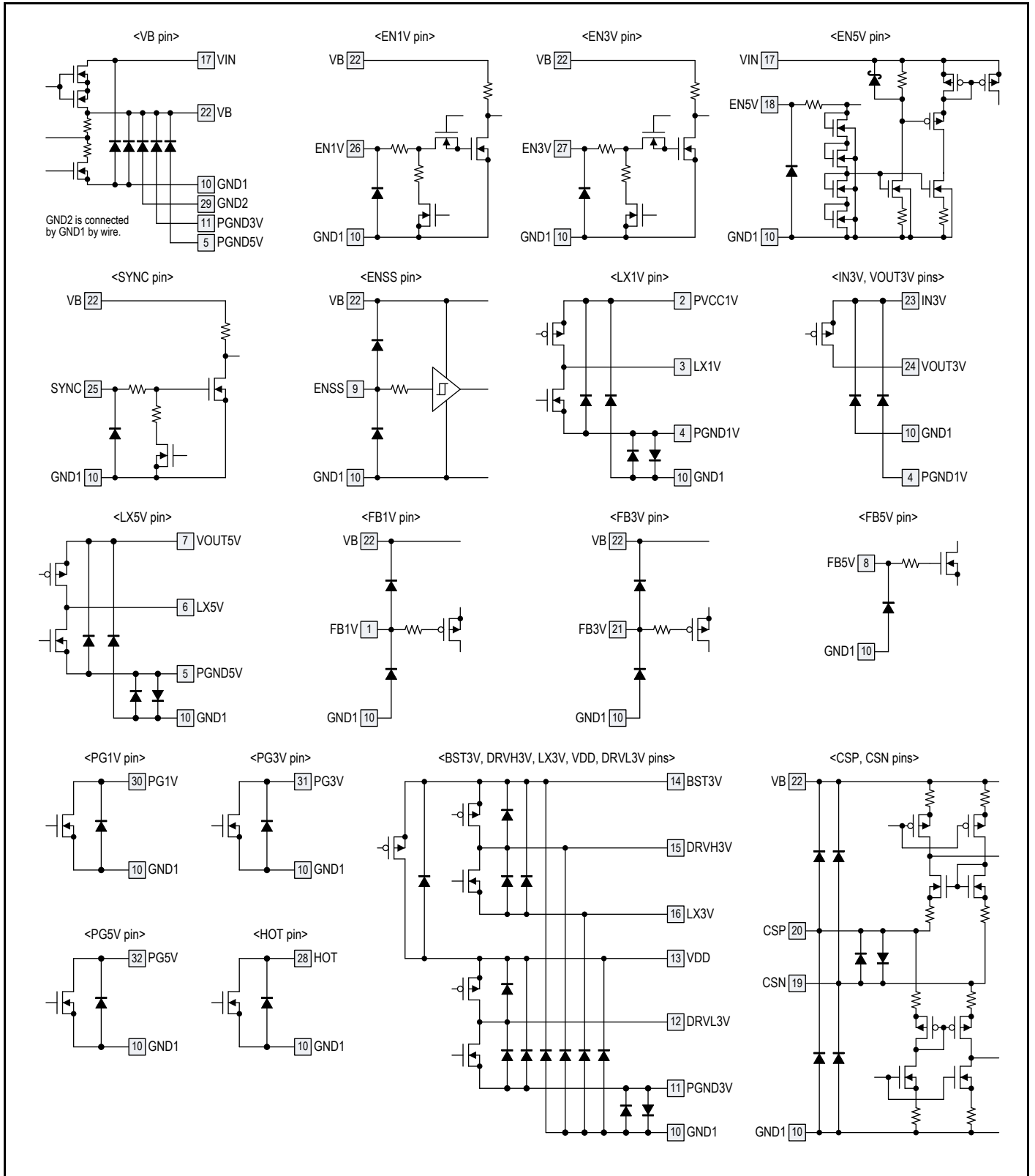

### 4. Architecture Block Diagram

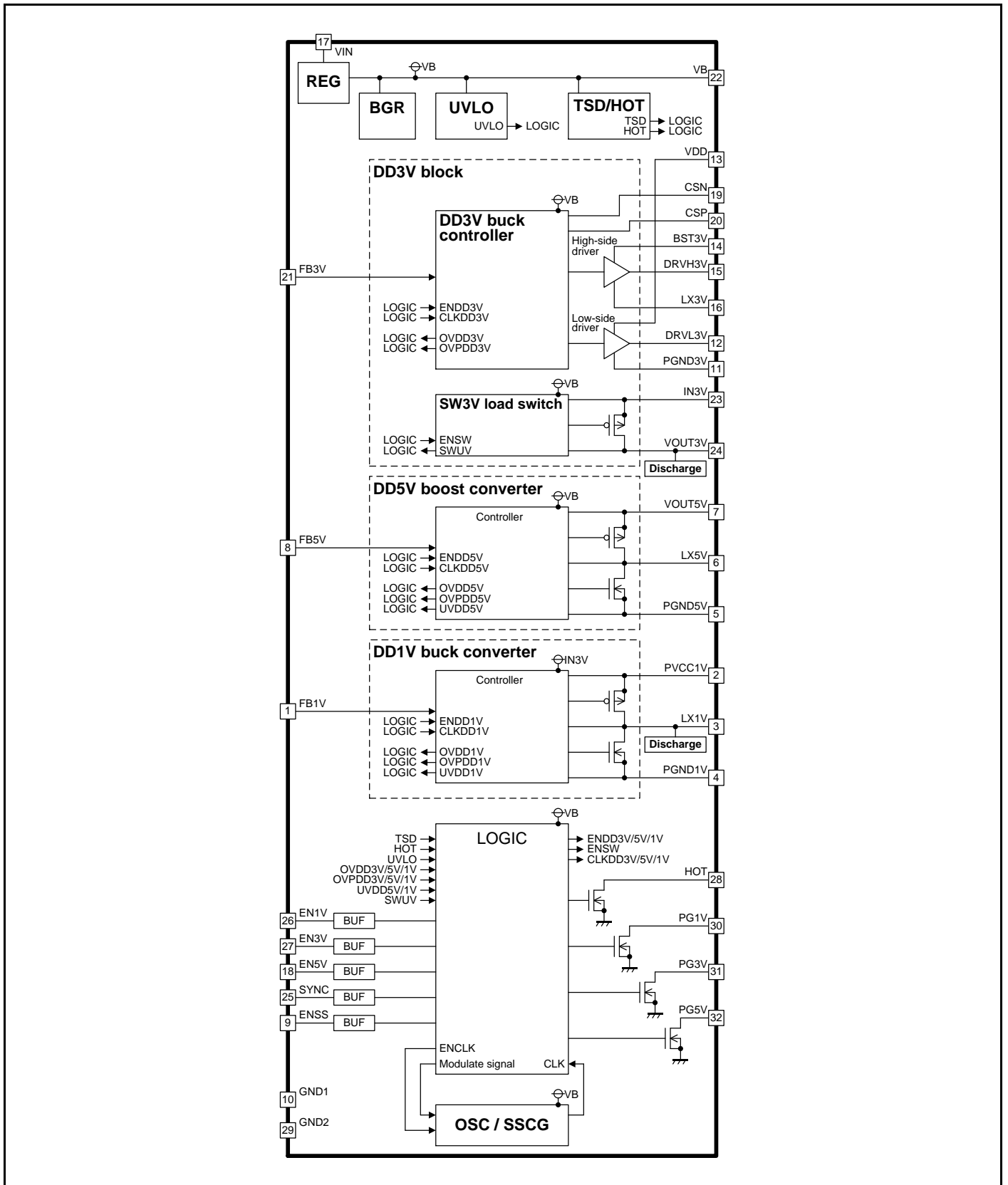



## 5. Absolute Maximum Ratings

Parameter	Symbol	Condition	Rating		Unit
			Min	Max	
Power supply voltage (*1)	V <sub>VIN</sub>	VIN pin	-0.3	+48	V
	V <sub>VB</sub>	VB pin	-0.3	+6.9	V
	V <sub>VDD</sub>	VDD pin	-0.3	+6.9	V
	V <sub>PVCC1V</sub>	PVCC1V pin	-0.3	+6.9	V
Pin voltage (*1)	V <sub>IN3V</sub>	IN3V pin	-0.3	+6.9	V
	V <sub>BST3V</sub>	BST3V pin	-0.3	+48	V
	V <sub>CSN</sub>	CSN pin	-0.3	V <sub>VB</sub>	V
	V <sub>CSP</sub>	CSP pin	-0.3	V <sub>VB</sub>	V
	V <sub>FB1V</sub>	FB1V pin	-0.3	V <sub>VB</sub>	V
	V <sub>FB3V</sub>	FB3V pin	-0.3	V <sub>VB</sub>	V
	V <sub>FB5V</sub>	FB5V pin	-0.3	+6.9	V
	V <sub>EN1V</sub>	EN1V pin	-0.3	+6.9	V
	V <sub>EN3V</sub>	EN3V pin	-0.3	+6.9	V
	V <sub>EN5V</sub>	EN5V pin	-0.3	+48	V
	V <sub>PG1V</sub>	PG1V pin	-0.3	+6.9	V
	V <sub>PG3V</sub>	PG3V pin	-0.3	+6.9	V
	V <sub>PG5V</sub>	PG5V pin	-0.3	+6.9	V
	V <sub>HOT</sub>	HOT pin	-0.3	+6.9	V
	V <sub>ENSS</sub>	ENSS pin	-0.3	V <sub>VB</sub>	V
V <sub>SYNC</sub>	SYNC pin	-0.3	+6.9	V	
LX voltage (*1)	V <sub>LX1V</sub>	LX1V pin	-0.3	+6.9	V
	V <sub>LX3V</sub>	LX3V pin	-0.3	+48	V
	V <sub>LX5V</sub>	LX5V pin	-0.3	+6.9	V
Difference voltage	V <sub>BST3V_LX3V</sub>	BST3V to LX3V	-0.3	+6.9	V
	V <sub>DRVH3V_LX3V</sub>	DRVH3V to LX3V	-0.3	+6.9	V
	V <sub>DRVL3V_PGND3V</sub>	DRVL3V to PGND3V	-0.3	+6.9	V
	V <sub>LX5V_VOUT5V</sub>	LX5V to VOUT5V	-0.3	+6.9	V
	V <sub>LX1_PVCC1V</sub>	LX1 to PVCC1V	-0.3	+6.9	V
	V <sub>PGND1_GND</sub>	PGND1V to GND1, PGND1V to GND2	-0.3	+0.3	V
	V <sub>PGND3_GND</sub>	PGND3V to GND1, PGND3V to GND2	-0.3	+0.3	V
	V <sub>PGND5_GND</sub>	PGND5V to GND1, PGND5V to GND2	-0.3	+0.3	V
	V <sub>VIN_EN5V</sub>	VIN to EN5V	-0.3	+48	V
Output current	I <sub>PG</sub>	PG1V, PG3V, PG5V sink current	-3	0	mA
	I <sub>HOT</sub>	HOT sink current	-3	0	mA
Power dissipation (*1)	P <sub>D</sub>	T <sub>a</sub> ≤ ±25°C	0	4280 (*2)	mW
Storage temperature	T <sub>STG</sub>	-	-55	+150	°C

\*1: PGND1V = PGND3V = PGND5V = GND1 = GND2 = 0V

\*2: When the product is mounted on 76.2 mm × 114.3 mm, four-layer FR-4 board

### Warning:

- Semiconductor devices may be permanently damaged by application of stress (including, without limitation, voltage, current or temperature) in excess of absolute maximum ratings. Do not exceed any of these ratings.

## 6. Recommended Operating Conditions

Parameter	Symbol	Condition		Value			Unit
				Min	Typ	Max	
Power supply voltage (*1)	V <sub>VIN_START</sub>	VIN pin	At initial start-up	+6.8	–	–	V
	V <sub>VIN</sub>	VIN pin	After start-up	+4.5	+12	+42	V
			After start-up, Ta = 25°C	+3.7	+12	+42	V
			After start-up, Ta = 25°C, VOUT5V current = 1 mA, V <sub>EN1V</sub> = V <sub>EN3V</sub> = 0V	+2.5	+12	+42	V
	V <sub>VDD</sub>	VDD pin		–	V <sub>VOUT5V</sub>	–	V
	V <sub>PVCC1V</sub>	PVCC1V pin		–	+3.3	–	V
V <sub>IN3V</sub>	IN3V pin		–	+3.3	–	V	
Pin voltage (*1)	V <sub>EN1V</sub>	EN1V pin		0	–	+5.5	V
	V <sub>EN3V</sub>	EN3V pin		0	–	+5.5	V
	V <sub>EN5V</sub>	EN5V pin		0	–	V <sub>VIN</sub>	V
	V <sub>PG1V</sub>	PG1V pin		0	–	+5.5	V
	V <sub>PG3V</sub>	PG3V pin		0	–	+5.5	V
	V <sub>PG5V</sub>	PG5V pin		0	–	+5.5	V
	V <sub>HOT</sub>	HOT pin		0	–	+5.5	V
	V <sub>ENSS</sub>	ENSS pin		0	–	V <sub>VB</sub>	V
	V <sub>SYNC</sub>	SYNC pin		0	–	+5.5	V
Input clock frequency	F <sub>SYNC</sub>	SYNC pin		1.8	2.1	2.4	MHz
Input clock duty range	D <sub>SYNC</sub>	SYNC pin		48	50	52	%
LX voltage (*1)	V <sub>LX5V</sub>	LX5V pin		0	–	+5.5	V
DD1V output voltage (*1)	V <sub>VOUT1V</sub>	Voltage of DD1V output capacitor		1.0	–	1.3	V
DD3V output voltage (*1)	V <sub>IN3V</sub> (*2)	Voltage of DD3V output capacitor, IN3V pin		3.2	–	3.4	V
DD5V output voltage (*1)	V <sub>VOUT5V</sub>	VOUT5V pin		5.0	–	5.2	V
BST capacitance	C <sub>BST</sub>	BST3V to LX3V		0.068	0.1	0.47	μF
VB capacitance	C <sub>VB</sub>	VB to GND		2.2	4.7	10	μF
Operating ambient temperature	Ta	–		–40	+25	+105	°C

\*1: PGND1V = PGND3V = PGND5V = GND1 = GND2 = 0V

\*2: V<sub>IN3V</sub> is defined as DD3V output voltage, and V<sub>VOUT3V</sub> (VOUT3V pin voltage) is defined as the DD3V output voltage via SW3V.

### Warning:

1. The recommended operating conditions are required in order to ensure the normal operation of the semiconductor device. All of the device's electrical characteristics are warranted when the device is operated under these conditions.
2. Any use of semiconductor devices will be under their recommended operating condition.
3. Operation under any conditions other than these conditions may adversely affect reliability of device and could result in device failure.
4. No warranty is made with respect to any use, operating conditions or combinations not represented on this data sheet. If you are considering application under any conditions other than listed herein, please contact sales representatives beforehand.

## 7. Electrical Characteristics

$$V_{VIN} = V_{EN5V} = 12V, V_{PVCC1V} = 3.3V, V_{VB} = V_{VDD} = V_{EN1V} = V_{EN3V} = 5.0V$$

(Unless specified otherwise, these are the electrical characteristics under the recommended operating environment.)

Parameter		Symbol	Condition	Value			Unit	
				Min	Typ	Max		
Supply current	Shutdown current	I <sub>SHDN</sub>	V <sub>VIN</sub> pin current, V <sub>VIN</sub> = 12V, V <sub>EN1V</sub> = V <sub>EN3V</sub> = V <sub>EN5V</sub> = 0V	-	1.0	2.0	μA	
	Quiescent current	I <sub>q</sub>	V <sub>VIN</sub> pin current, V <sub>VIN</sub> = 12V, V <sub>SYNC</sub> = 0V, V <sub>EN1V</sub> = V <sub>EN3V</sub> = 0V, V <sub>EN5V</sub> = 12V, All DC/DC converters with no load, External FET: NVTFS5826NL	-	15 (*1)	25 (*1)	μA	
	VB supply current	I <sub>VB</sub>	VB pin current, V <sub>VB</sub> = 5V, V <sub>SYNC</sub> = V <sub>VB</sub> , V <sub>EN1V</sub> = V <sub>EN3V</sub> = 5V, V <sub>EN5V</sub> = 12V, All DC/DC converters with no load	-	20	25	mA	
UVLO block	IC operation start voltage	V <sub>UVLO_START</sub>	VB pin, V <sub>VB</sub> rising	4.3	4.4	4.5	V	
	IC shutdown voltage	V <sub>UVLO_SHDN</sub>	VB pin, V <sub>VB</sub> falling	4.2	4.3	4.4	V	
DD1V block	Feedback voltage	V <sub>FB1V</sub>	FB1V pin	0.591 (-1.5%)	0.6	0.609 (+1.5%)	V	
	Output regulation	-	DD1V output voltage (V <sub>OUT1V</sub> ), V <sub>PVCC1V</sub> = V <sub>IN3V</sub> = 3.3V, I <sub>OUT1V</sub> = 0 to 2.0A	-1.5 (*1)	-	+1.5 (*1)	%	
	Over voltage protection (OVP) voltage	V <sub>OVPR_1V</sub>	Monitoring V <sub>FB1V</sub> rising	128.0	131.5	135.0	%	
	Over voltage protection release voltage	V <sub>OVPF_1V</sub>	Monitoring V <sub>LX1V</sub> falling	-	-	0.94 (*1)	V	
	High-side FET ON resistance	R <sub>ONH_1V</sub>	I <sub>LX1V</sub> = 50 mA (PVCC1V to LX1V)	-	130	260	mΩ	
	Low-side FET ON resistance	R <sub>ONL_1V</sub>	I <sub>LX1V</sub> = -50 mA (LX1V to PGND1V)	-	100	200	mΩ	
	FET leak current	I <sub>LEAK_1V</sub>	V <sub>PVCC1V</sub> = 5.0V, V <sub>EN1V</sub> = 0V	-	-	3	μA	
	Maximum output current	I <sub>OUTMAX_1V</sub>	L = 1.5 μH	S6BP501A	1.4 (*1)	-	-	A
				S6BP502A	2.0 (*1)	-	-	A
	Over current protection current (LX peak current)	I <sub>LXPEAK_1V</sub>	L = 1.5 μH	S6BP501A	1.75 (*1)	-	-	A
				S6BP502A	2.5 (*1)	-	-	A
Discharge resistance	R <sub>DIS_1V</sub>	LX1V pin	280	400	520	Ω		
Soft-start time	t <sub>SS_1V</sub>	-	0.5	1.0	2.0	ms		
DD3V block	Feedback voltage	V <sub>FB3V</sub>	FB3V pin	0.8865 (-1.5%)	0.9	0.9135 (+1.5%)	V	
	Output regulation	-	IN3V pin, V <sub>VIN</sub> = 4.5V to 42V, I <sub>IN3V</sub> = 0A to 5.1A	-1.25 (*1)	-	+1.25 (*1)	%	
	PWM/PFM switching current	I <sub>PWMPFM_3V</sub>	-	-	1000 (*1)	-	mA	
	Over voltage protection (OVP) voltage	V <sub>OVPR_3V</sub>	Monitoring V <sub>CSN</sub> rising	3.70	3.85	4.00	V	
	Over voltage protection release voltage	V <sub>OVPF_3V</sub>	Monitoring V <sub>IN3V</sub> falling	-	-	0.94 (*1)	V	
	Dead time	t <sub>DEAD_3V</sub>	-	10	20	-	ns	
	Maximum duty cycle	D <sub>MAX_3V</sub>	V <sub>VIN</sub> < V <sub>IN3V</sub>	-	-	100	%	
	Soft-start time	t <sub>SS_3V</sub>	-	0.5	1.0	2.0	ms	

$V_{VIN} = V_{EN5V} = 12V$ ,  $V_{PVCC1V} = 3.3V$ ,  $V_{VB} = V_{VDD} = V_{EN1V} = V_{EN3V} = 5.0V$

(Unless specified otherwise, these are the electrical characteristics under the recommended operating environment.)

Parameter		Symbol	Condition	Value			Unit	
				Min	Typ	Max		
DD3V block	High-side output driver	ON resistance	$R_{ONH\_3V}$	DRVH3V pin current = 10 mA, (BST3V to DRVH3V)	-	15	30	$\Omega$
			$R_{ONL\_3V}$	DRVH3V pin current = -50 mA, (DRVH3V to LX3V)	-	1	3	$\Omega$
	Low-side output driver	ON resistance	$R_{ONH\_3V}$	DRVL3V pin current = 50 mA, (LX3V to DRVL3V)	-	1.5	4	$\Omega$
			$R_{ONL\_3V}$	DRVL3V pin current = -50 mA, (DRVL3V to LX3V)	-	0.75	2	$\Omega$
	Boost switch	ON resistance	$R_{ON\_BSTSW}$	$I_{BST3V} = 10\text{ mA}$	-	8	24	$\Omega$
		Leak current	$I_{R\_BSTSW}$	$V_{BST3V} = 47V$	-	-	2	$\mu A$
	Output current monitor	Over current limit	-	$V_{CSP} - V_{CSN}$	60	80	100	mV
		CSP input current	$I_{CSP}$	Fixed PWM operation	-	2	5	$\mu A$
		CSN input current	$I_{CSN}$	Fixed PWM operation	-	8	20	$\mu A$
	SW3V block	ON resistance	$R_{ON\_SW3V}$	$I_{N3V} \text{ to } V_{OUT3V} \text{ current} = 50\text{ mA}$	-	-	100	m $\Omega$
		Maximum output current	$I_{LOAD\_SW3V}$	S6BP501A	1.6 (*1)	-	-	A
				S6BP502A	1.9 (*1)	-	-	A
		Leak current	$I_{LEAK\_SW3V}$	$V_{IN3V} = 3.3V$ , $V_{EN3V} = 0V$	-	-	3	$\mu A$
		Discharge resistance	$R_{DIS\_SW3V}$	-	280	400	520	$\Omega$
Soft-start time	$t_{SS\_SW3V}$	-	1.0	2.0	4.0	ms		
DD5V block	Feedback voltage	$V_{FB5V}$	FB5V pin	1.182 (-1.5%)	1.2	1.218 (+1.5%)	V	
	Output regulation	-	DD5V output voltage ( $V_{VOUT5V}$ ), $V_{IN3V} = 3.3V$ , $I_{VOUT5V} = 0A \text{ to } 1.3A$	-3.0 (*1)	-	+3.0 (*1)	%	
	PWM/PFM switching current	$I_{PWMPFM\_5V}$	-	-	300 (*1)	-	mA	
	Over voltage protection (OVP) voltage	$V_{OVPR\_5V}$	Monitoring $V_{VOUT5V}$ rising	5.6	5.8	6.0	V	
	Over voltage protection release voltage	$V_{OVPR\_5V}$	Monitoring $V_{VOUT5V}$ falling	-	-	0.94 (*1)	V	
	High-side FET ON resistance	$R_{ONH\_5V}$	$I_{LX5V} = 50\text{ mA}$ ( $V_{OUT5V}$ to $LX5V$ )	-	130	260	m $\Omega$	
	Low-side FET ON resistance	$R_{ONL\_5V}$	$I_{LX5V} = -50\text{ mA}$ ( $LX5V$ to $PGND5V$ )	-	100	200	m $\Omega$	
	FET leak current	$I_{LEAK\_5V}$	$V_{VOUT5V} = 5.0V$ , $V_{EN5V} = 0V$	-	-	3	$\mu A$	
	Maximum output current	$I_{OUT\_MAX5V}$	L = 1.5 $\mu H$	S6BP501A	1.3 (*1)	-	-	A
				S6BP502A	1.3 (*1)	-	-	A
	Over current protection current (LX peak current)	$I_{LX\_PEAK5V}$	L = 1.5 $\mu H$	S6BP501A	2.5 (*1)	-	-	A
				S6BP502A	2.5 (*1)	-	-	A
Soft-start time	$t_{SS\_5V}$	$V_{VOUT5V} = 3.3V > 5.0V$	0.2	0.5	1.0	ms		

$V_{VIN} = V_{EN5V} = 12V$ ,  $V_{PVCC1V} = 3.3V$ ,  $V_{VB} = V_{VDD} = V_{EN1V} = V_{EN3V} = 5.0V$

(Unless specified otherwise, these are the electrical characteristics under the recommended operating environment.)

Parameter		Symbol	Condition	Value			Unit
				Min	Typ	Max	
EN1V pin	ON condition	$V_{ON\_EN1V}$	–	2.0	–	–	V
	OFF condition	$V_{OFF\_EN1V}$	–	–	–	0.4	V
	Input current	$I_{ON\_EN1V}$	$V_{EN1V} = 5.0V$	–	50	100	$\mu A$
	Pull down resistance	$R_{PULL\_EN1V}$	–	50	100	150	k $\Omega$
EN3V pin	ON condition	$V_{ON\_EN3V}$	–	2.0	–	–	V
	OFF condition	$V_{OFF\_EN3V}$	–	–	–	0.4	V
	Input current	$I_{ON\_EN3V}$	$V_{EN3V} = 5.0V$	–	50	100	$\mu A$
	Pull down resistance	$R_{PULL\_EN3V}$	–	50	100	150	k $\Omega$
EN5V pin	ON condition	$V_{ON\_EN5V}$	–	2.5	–	–	V
	OFF condition	$V_{OFF\_EN5V}$	–	–	–	0.2	V
	Input current	$I_{ON\_EN5V}$	$V_{EN5V} = 12.0V$	–	1	3	$\mu A$
		$I_{OFF\_EN5V}$	$V_{EN5V} = 0V$	–	0	1	$\mu A$
PG1V pin	Over voltage detection (OVD) voltage	$V_{OVDR\_PG1V}$	Monitoring $V_{FB1V}$ rising	105.0	106.5	108.0	%
	Over voltage detection release voltage	$V_{OVDF\_PG1V}$	Monitoring $V_{FB1V}$ falling	–	105.5	–	%
	Under voltage detection (UVD) voltage	$V_{UVDF\_PG1V}$	Monitoring $V_{FB1V}$ falling	92.5	94.0	95.5	%
	Under voltage detection release voltage	$V_{UVDR\_PG1V}$	Monitoring $V_{FB1V}$ rising	–	95.0	–	%
	Leak current	$I_{LEAK\_PG1V}$	$V_{PG1V} = 5.0V$	–	–	1	$\mu A$
	Low level voltage	$V_{LOW\_PG1V}$	$I_{PG1V} = 3\text{ mA}$	–	0.15	0.30	V
	Power-on reset time	$t_{POR\_PG1V}$	$V_{SYNC} = 0V$	8	10	12	ms
PG3V pin	Over voltage detection (OVD) voltage	$V_{OVDR\_PG3V}$	Monitoring $V_{FB3V}$ rising	104.5	106.0	107.5	%
	Over voltage detection release voltage	$V_{OVDF\_PG3V}$	Monitoring $V_{FB3V}$ falling	–	105.0	–	%
	Under voltage detection (UVD) voltage	$V_{UVDF\_PG3V}$	Monitoring $V_{VOUT3V}$ falling	3.004	3.050	3.096	V
	Under voltage detection release voltage	$V_{UVDR\_PG3V}$	Monitoring $V_{VOUT3V}$ rising	–	3.080	–	V
	Leak current	$I_{LEAK\_PG3V}$	$V_{PG3V} = 5.0V$	–	–	1	$\mu A$
	Low level voltage	$V_{LOW\_PG3V}$	$I_{PG3V} = 3\text{ mA}$	–	0.15	0.30	V
	Power-on reset time	$t_{POR\_PG3V}$	$V_{SYNC} = 0V$	8	10	12	ms
PG5V pin	Over voltage detection (OVD) voltage	$V_{OVDR\_PG5V}$	Monitoring $V_{FB5V}$ rising	106.0	108.0	110.0	%
	Over voltage detection release voltage	$V_{OVDF\_PG5V}$	Monitoring $V_{FB5V}$ falling	–	107.0	–	%
	Under voltage detection (UVD) voltage	$V_{UVDF\_PG5V}$	Monitoring $V_{FB5V}$ falling	90.0	92.0	94.0	%
	Under voltage detection release voltage	$V_{UVDR\_PG5V}$	Monitoring $V_{FB5V}$ rising	–	93.0	–	%
	Leak current	$I_{LEAK\_PG5V}$	$V_{PG5V} = 5.0V$	–	–	1	$\mu A$
	Low level voltage	$V_{LOW\_PG5V}$	$I_{PG5V} = 3\text{ mA}$	–	0.15	0.30	V
	Power-on reset time	$t_{POR\_PG5V}$	$V_{SYNC} = 0V$	8	10	12	ms

$V_{IN} = V_{EN5V} = 12V$ ,  $V_{PVC1V} = 3.3V$ ,  $V_{VB} = V_{VDD} = V_{EN1V} = V_{EN3V} = 5.0V$

(Unless specified otherwise, these are the electrical characteristics under the recommended operating environment.)

Parameter		Symbol	Condition	Value			Unit
				Min	Typ	Max	
TSD block	Operation shutdown temperature	$T_{TSDR}$	$T_j$ (*2) rising	-	+165 (*1)	-	°C
	Operation restart temperature	$T_{TSDF}$	$T_j$ (*2) falling	-	+155 (*1)	-	°C
HOT pin	Thermal warning indicator temperature	$T_{TWIR\_HOT}$	$T_j$ (*2) rising	-	+140 (*1)	-	°C
	Thermal warning indicator release temperature	$T_{TWIF\_HOT}$	$T_j$ (*2) falling	-	+130 (*1)	-	°C
	Leak current	$I_{LEAK\_HOT}$	$V_{HOT} = 5.0V$	-	-	1	µA
	Low level voltage	$V_{LOW\_HOT}$	$I_{PG} = 3\text{ mA}$	-	0.15	0.30	V
OSC block	Switching frequency	$F_{OSC1}$	DD1V, DD5V, In internal clock operation	1.9	2.1	2.3	MHz
		$F_{OSC2}$	DD3V, $F_{OSC2} = F_{OSC1} / 5$ , In internal clock operation	0.38	0.42	0.46	MHz
SYNC Pin/ SYNC block	High level voltage	$V_{HIGH\_SYNC}$	In external clock input	2.0	-	-	V
	Low level voltage	$V_{LOW\_SYNC}$	In external clock input	-	-	0.4	V
	Input current	$I_{IN\_SYNC}$	$V_{SYNC} = 5.0V$	-	50	100	µA
	Pull down resistance	$R_{PULL\_SYNC}$	-	50	100	150	kΩ
	Input frequency	$F_{IN\_SYNC}$	In external clock input	1.8	-	2.4	MHz
	Switching frequency	$F_{OSC1\_SYNC}$	DD1V, DD5V, $F_{OSC1\_SYNC} = F_{IN\_SYNC}$ , In external clock operation	1.8	-	2.4	MHz
		$F_{OSC2\_SYNC}$	DD3V, $F_{OSC2\_SYNC} = F_{IN\_SYNC} / 5$ , In external clock operation	0.36	-	0.48	MHz
SSCG block	Modulation range	-	$V_{ENSS} = V_{VB}$	3	6 (*1)	9	%
	Modulation frequency	$F_{MOD}$	Composite modulation method is used Average of modulation frequency	3	4	5	kHz
ENSS pin	ON condition	$V_{ON\_ENSS}$	SSCG function ON	$V_{VB} \times 0.8$	-	-	V
	OFF condition	$V_{OFF\_ENSS}$	SSCG function OFF	-	-	$V_{VB} \times 0.2$	V
	Input current	$I_{ENSS}$	-	-0.1	-	+0.1	µA

\*1: The electrical characteristic is ensured by statistical characterization and indirect tests.

\*2: Junction temperature

## 8. Functional Description

### 8.1 Operation Sequence

The operation sequence of this IC is described in this section.

**Figure 8-1 Turn On and Turn Off Sequence**

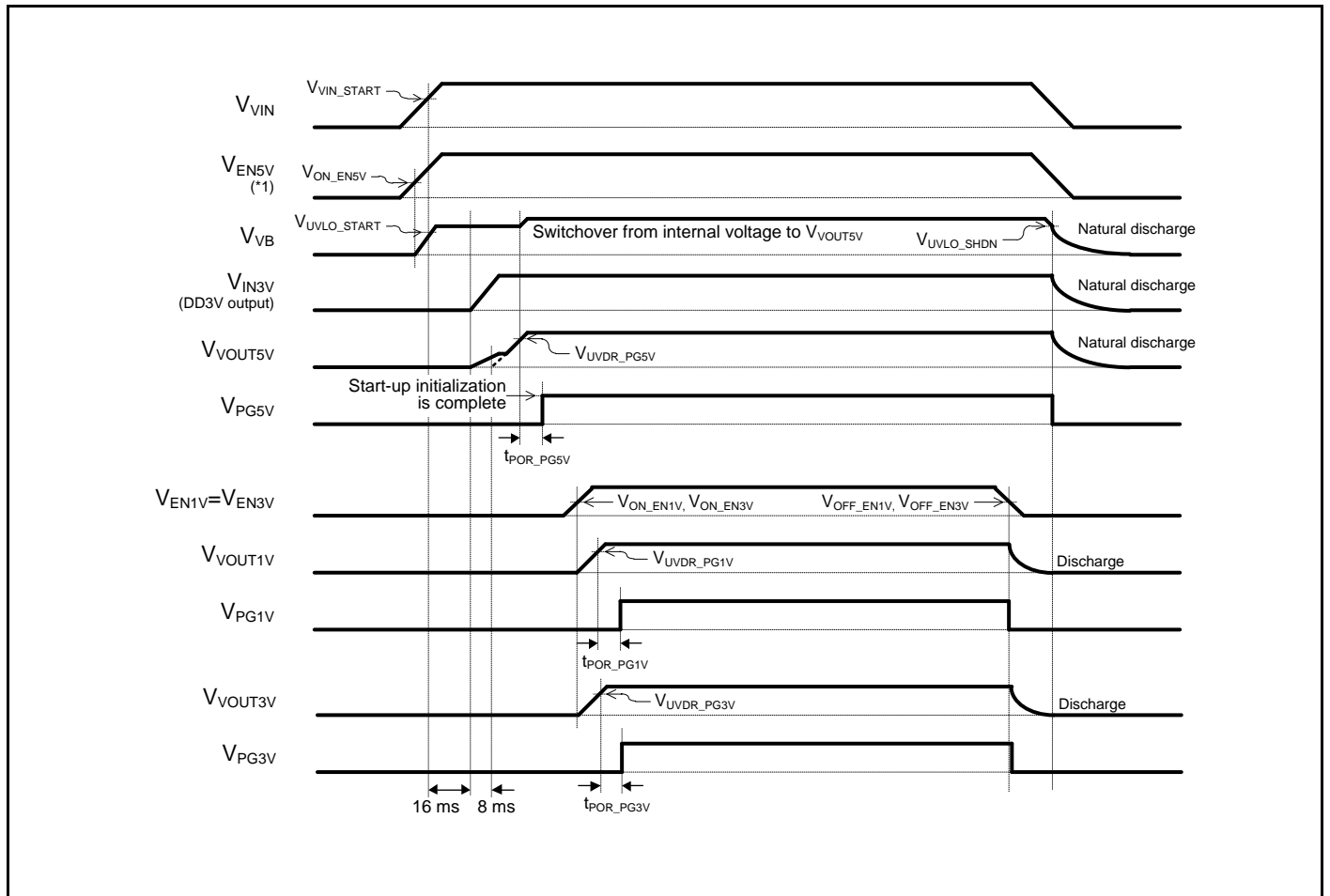

\*1: When the  $V_{EN5V}$  drops to the  $V_{OFF\_EN5V}$  while supplying a power to the VIN pin, the voltages,  $V_{PG1V}$ ,  $V_{PG3V}$ ,  $V_{PG5V}$  and  $V_{HOT}$ , are undefined.

## 8.2 Each Function Block

Each function block is described in this section.

### Under Voltage Lockout (UVLO)

This IC equips an UVLO function in order to prevent itself from operating unintentionally and from destructing or deteriorating its subsequent devices. The UVLO block monitors the VB voltage. Once VB unintentionally drops below the IC shutdown voltage ( $V_{UVLO\_SHDN}$ ), UVLO block prohibits the regulators and controllers switching FETs until VB becomes higher than the IC operation start voltage ( $V_{UVLO\_START}$ ).

### Over Voltage Detection and Protection (OVD, OVP)

When an output voltage exceeds the over voltage detection (OVD) voltage, the corresponding PG is asserted the low level. In case any output voltage exceeds the over voltage protection (OVP) voltage, all output channels stop working to protect the connected devices. When all output voltage fall below the over voltage protection release voltage, this IC returns to the normal operation.

Figure 8-2 Over Voltage Detection and Over Voltage Protection Sequence

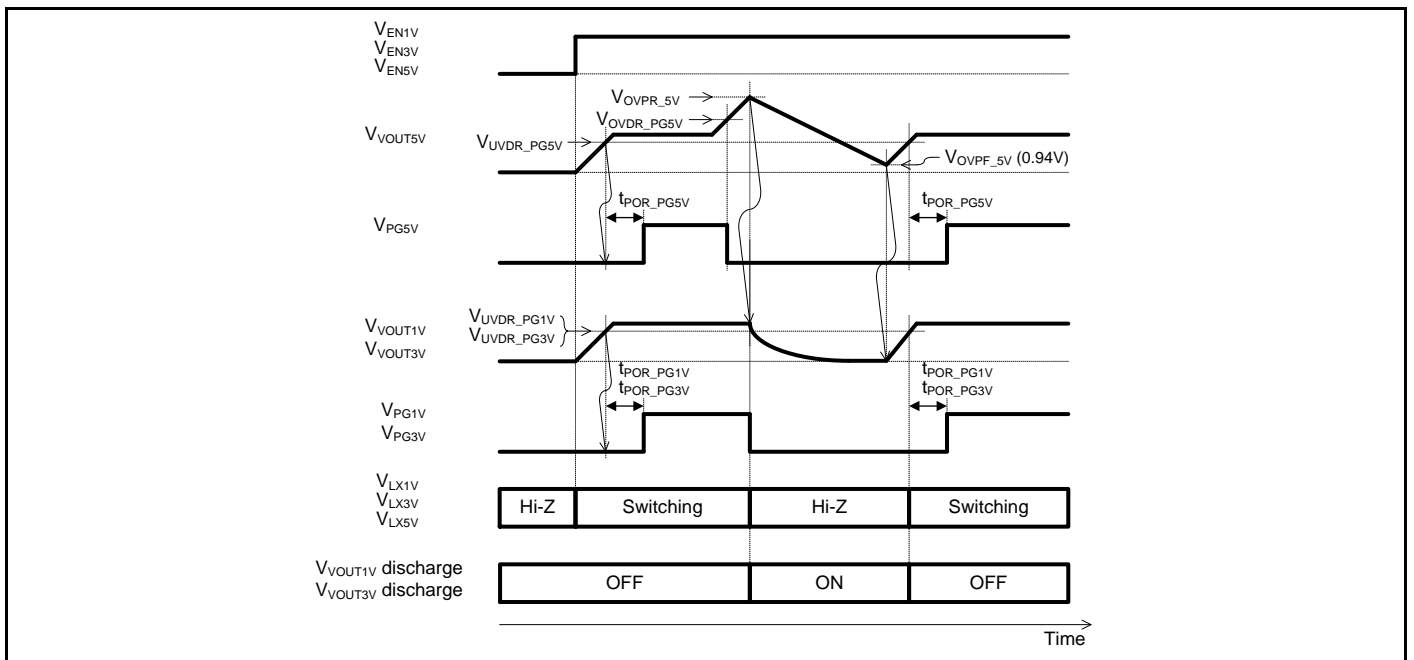

### Under Voltage Detection (UVD)

When an output voltage falls below the under voltage detection (UVD) voltage, the corresponding PG pin is asserted the low level while the corresponding output channel keeps working. When the output voltage exceeds the under voltage detection release voltage, each PG will be recovered Hi-Z.



Figure 8-3 Under Voltage Detection Sequence

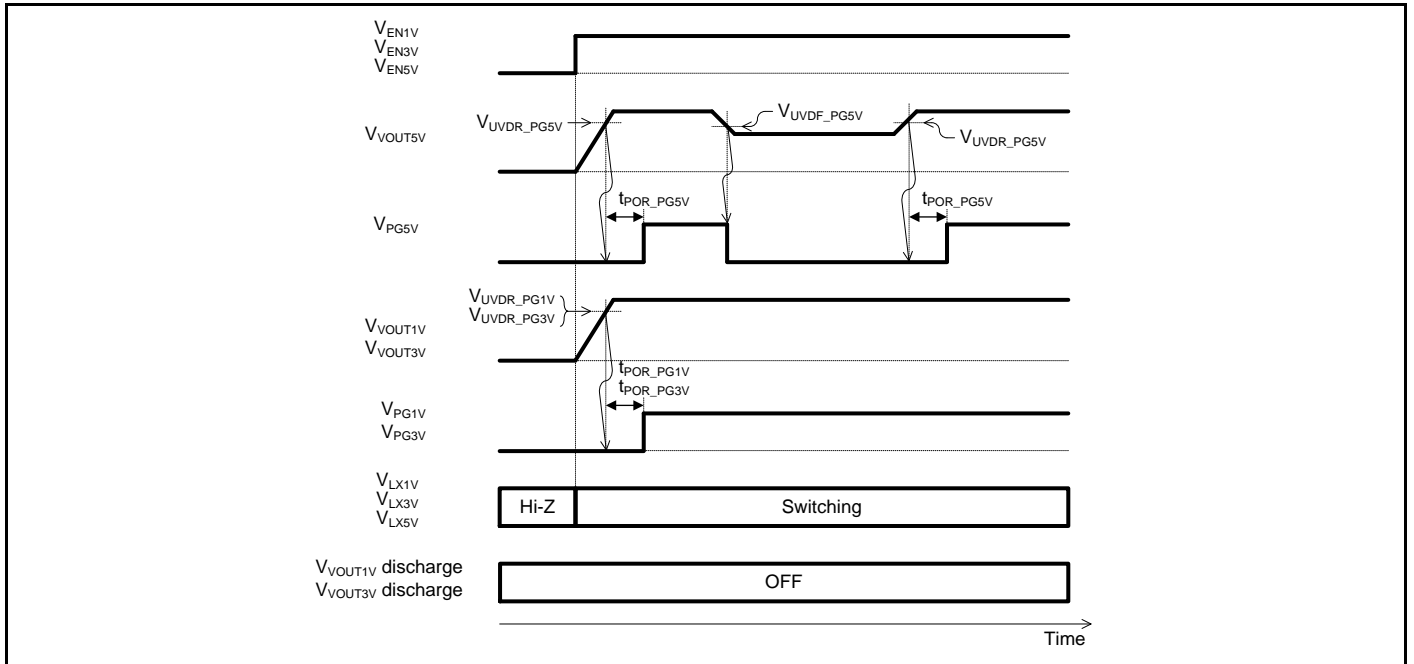

**Over Current Protection (OCP)**

In order to protect FETs from an excessive current, each output channel equips the OCP (over current protection) that sets current limits by monitoring the corresponding over current protection current (LX peak current).

**Thermal Shutdown (TSD)**

The Thermal shutdown prevents this IC from a thermal destruction. If the junction temperature exceeds +165°C, all DC/DC converters stop working. When the junction temperature falls below +155°C, this IC returns to the normal operation.

**Thermal Warning Indicator (HOT)**

Prior to TSD, this IC is able to notice its subsequent devices that it is close to the limit temperature. The HOT pin is an open-drain output. If the junction temperature reaches +140°C, the HOT pin is asserted the low level. When the junction temperature falls below +130°C, the HOT pin will be recovered Hi-Z.

**Figure 8-4 Thermal Shutdown and Thermal Warning Indicator Sequence**

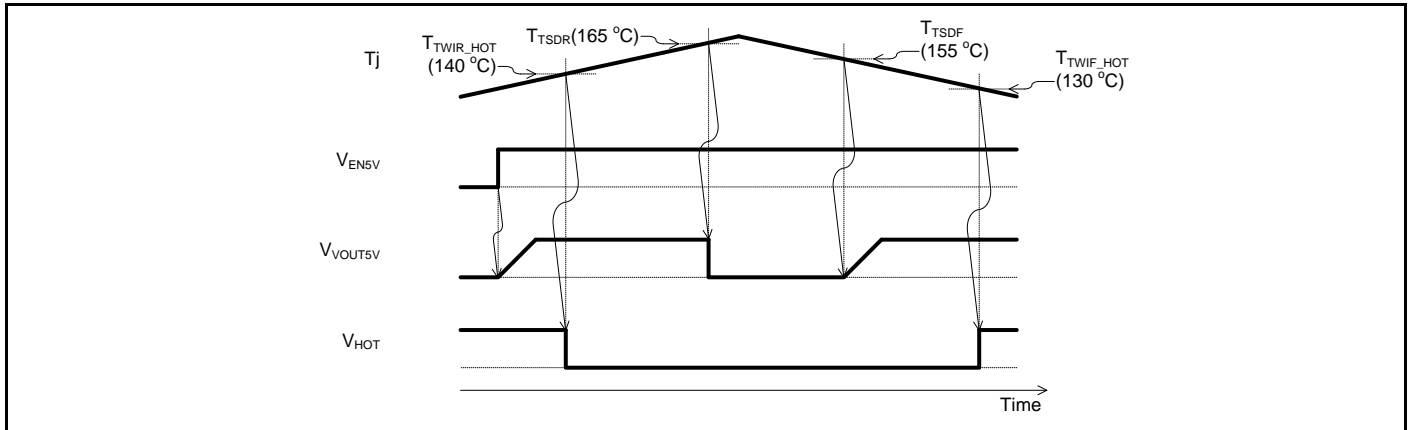

### SSCG

This IC equips a SSCG (spread spectrum clock generator) function. When SSCG function turns on, it decreases EMI noise immediately. SSCG function modulates the clock signal by 0% to +6%, which clock signal can be sourced from the internal oscillator or an external clock source.

**Table 8-1 SSCG Pin Setting**

ENSS Pin Setting (*1)	SSCG Operation
L	SSCG function turns off. DD1V, DD3V and DD5V are provided with non-modulated clock
H	SSCG function turns on. DD1V, DD3V and DD5V are provided modulated.

\*1: The H means  $V_{ENSS} > V_{ON\_ENSS}$ . The L means  $V_{ENSS} < V_{OFF\_ENSS}$ .

### SYNC

This IC equips a SYNC function that is to synchronize with an external clock signal supplied from SYNC. Also, the switching between the automatic PWM/PFM switching operation or the fixed PWM operation is set by the SYNC pin. The Table 8-2 shows the state corresponding to each operation by the SYNC pin setting. Please refer to the Table 8-3 for the switching signals to be inputted to the SYNC pin and the availability. The switching frequency of the DD3V ( $F_{Osc2}$ ) is a signal obtained by one-fifth dividing an internal clock or an inputted external clock.

**Table 8-2 SYNC Pin Setting**

SYNC Pin Setting	DD1V Operation	DD3V Operation	DD5V Operation
L	Fixed PWM operation with internal clock	Automatic PWM/PFM switching operation with internal clock	Automatic PWM/PFM switching operation with internal clock
H	Fixed PWM operation with internal clock		
CLK	Fixed PWM operation synchronized with external clock		

**Table 8-3 Switching signals to be inputted to the SYNC pin**

Signals to be inputted to SYNC pin	Enable Pin Setting		Availability
	EN1V = EN3V	EN5V	
L ↔ CLK	L	H	Prohibited
L ↔ H	H	H	Available
H ↔ CLK	L or H	H	Available

**Figure 8-5 SYNC Function Sequence**

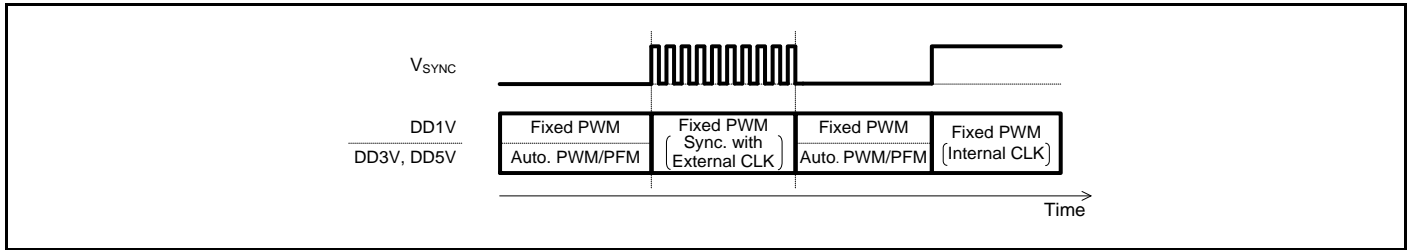

### 8.3 Output State and Protection Function Table

The following table shows the state of each output and each protection function.

**Table 8-4 Output State and Protection Function Table**

State	Enable Pin Setting (*1)		Output State (*2)				PG Pin Output (*3)			Remarks
	EN1V = EN3V	EN5V	DD1V	DD3V	SW3V	DD5V	PG1V	PG3V	PG5V	
DD1V, SW3V, DD5V are inactive	X	L	INA	INA	INA	INA	L	L	L	-
DD5V is active	L	H	INA	A	INA	A	L	L	Hi-Z	-
DD1V, SW3V, DD5V are active	H	H	A	A	A	A	Hi-Z	Hi-Z	Hi-Z	-
V <sub>VOUT1V</sub> OVD	H	H	A	A	A	A	L	Hi-Z	Hi-Z	V <sub>VOUT1V</sub> > V <sub>OVD</sub> PG1V
V <sub>VOUT3V</sub> OVD	H	H	A	A	A	A	Hi-Z	L	Hi-Z	V <sub>VOUT3V</sub> > V <sub>OVD</sub> PG3V
V <sub>VOUT5V</sub> OVD	H	H	A	A	A	A	Hi-Z	Hi-Z	L	V <sub>VOUT5V</sub> > V <sub>OVD</sub> PG5V
V <sub>VOUT1V</sub> OVP	H	H	INA	INA	INA	INA	L	L	L	V <sub>VOUT1V</sub> > V <sub>OVP</sub> 1V
V <sub>VOUT3V</sub> OVP	H	H	INA	INA	INA	INA	L	L	L	V <sub>VOUT3V</sub> > V <sub>OVP</sub> 3V
V <sub>VOUT5V</sub> OVP	X	H	INA	INA	INA	INA	L	L	L	V <sub>VOUT5V</sub> > V <sub>OVP</sub> 5V
V <sub>VOUT1V</sub> UVD	H	H	A	A	A	A	L	Hi-Z	Hi-Z	V <sub>VOUT1V</sub> < V <sub>UVD</sub> PG5V
V <sub>VOUT3V</sub> UVD	H	H	A	A	A	A	Hi-Z	L	Hi-Z	V <sub>VOUT3V</sub> < V <sub>UVD</sub> PG3V
V <sub>VOUT5V</sub> UVD	H	H	A	A	A	A	Hi-Z	Hi-Z	L	V <sub>VOUT5V</sub> < V <sub>UVD</sub> PG5V
TSD	X	H	INA	INA	INA	INA	L	L	L	T <sub>j</sub> > T <sub>TSD</sub>

\*1: The H means that each enable pin voltage is  $V_{EN1V} > V_{ON\_EN1V}$ ,  $V_{EN3V} > V_{ON\_EN3V}$ ,  $V_{EN5V} > V_{ON\_EN5V}$ .

The L means that each enable pin voltage is  $V_{EN1V} < V_{OFF\_EN1V}$ ,  $V_{EN3V} < V_{OFF\_EN3V}$ ,  $V_{EN5V} < V_{OFF\_EN5V}$ .

The X means that each enable pin voltage is the high level or the low level.

\*2: The A means the active state. The INA means the inactive state.

\*3: Each of the PG pins is formed as an open drain structure. In outputting the Hi-Z, the internal MOSFET is in the OFF state.

## 9. Application Circuit Example and Parts List

Figure 9-1 Application Circuit Example

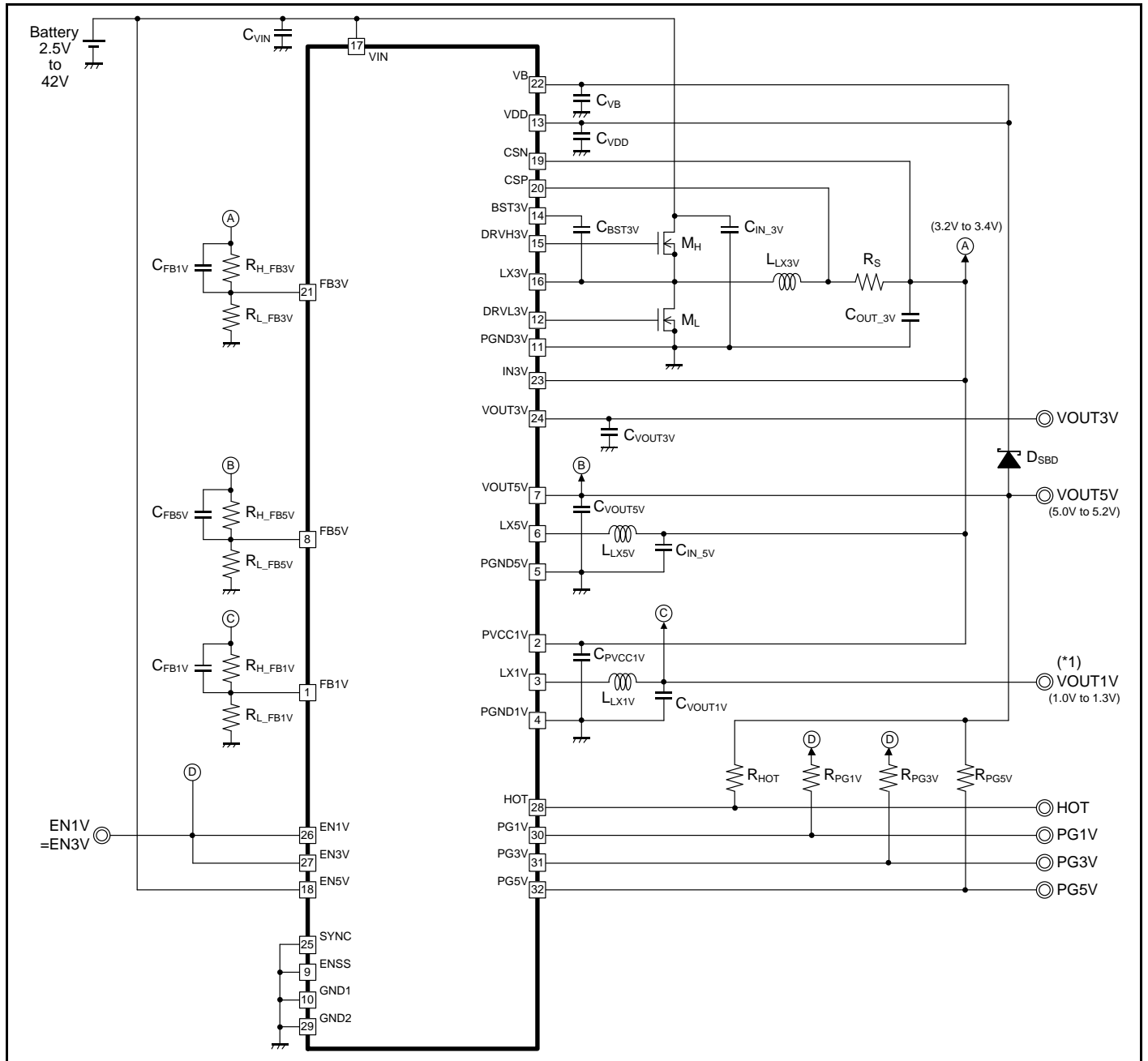

\*1: The VOUT1V is a pin name only for this circuit.

**Table 9-1 Parts List**

Block	Symbol	Item	Value	Part Number	Vendor	Size [mm]	Remarks
Common	C <sub>VIN</sub>	Capacitor	0.1 μF	CGA3E2X7R1H104K080AA	TDK	1.6 × 0.8 × 0.8	X7R, Rated voltage: 50 V <sub>DC</sub>
	C <sub>VB</sub>	Capacitor	4.7 μF	CGA4J3X7R1C475K125AB	TDK	2.0 × 1.2 × 1.25	X7R, Rated voltage: 16 V <sub>DC</sub>
	C <sub>VDD</sub>	Capacitor	0.1 μF	CGA3E2X7R1E104K080AA	TDK	1.6 × 0.8 × 0.8	X7R, Rated voltage: 25 V <sub>DC</sub>
	D <sub>SBD</sub>	SBD	V <sub>F</sub> : 0.5V	RB521S30T1G	ON	1.6 × 0.8 × 0.6	V <sub>R</sub> : 30 V <sub>DC</sub> , I <sub>F</sub> : 200 mA, I <sub>FSM</sub> : 1.0A
DD1V	R <sub>H_FB1V</sub>	Resistor	270 kΩ (*1)	RK73H1JTTD2703F	KOA	1.6 × 0.8 × 0.45	Rated power: 0.1W
	R <sub>L_FB1V</sub>	Resistor	270 kΩ (*1)	RK73H1JTTD2703F	KOA	1.6 × 0.8 × 0.45	Rated power: 0.1W
	C <sub>FB1V</sub>	Capacitor	12 pF	CGA3E2C0G1H120J080AA	TDK	1.6 × 0.8 × 0.8	C0G, Rated voltage: 50 V <sub>DC</sub>
	LL <sub>X1V</sub>	Inductor	1.5 μH	CLF6045NI-1R5N-D	TDK	7.4 × 7.0 × 4.8	DCR: 13 mΩ, I <sub>DC_MAX</sub> : 4.5A
	CP <sub>VCC1V</sub>	Capacitor	4.7 μF	CGA4J3X7R1C475K125AB	TDK	2.0 × 1.2 × 1.25	X7R, Rated voltage: 16 V <sub>DC</sub>
	CV <sub>OUT1V</sub>	Capacitor	22 μF × 2	CGA6P1X7R1C226M250AC	TDK	3.2 × 2.5 × 2.5	X7R, Rated voltage: 16 V <sub>DC</sub>
DD3V	R <sub>H_FB3V</sub>	Resistor	200 kΩ (*2)	RK73H1JTTD2003F	KOA	1.6 × 0.8 × 0.45	Rated power: 0.1W
		Resistor	120 kΩ (*2)	RK73H1JTTD1203F	KOA	1.6 × 0.8 × 0.45	Rated power: 0.1W
	R <sub>L_FB3V</sub>	Resistor	120 kΩ (*2)	RK73H1JTTD1203F	KOA	1.6 × 0.8 × 0.45	Rated power: 0.1W
	C <sub>FB3V</sub>	Capacitor	-	-	-	-	Unnecessary for this circuit
	LL <sub>X3V</sub>	Inductor	4.7 μH	CLF12577NIT-4R7N-D	TDK	12.8 × 12.5 × 8	DCR: 8.7 mΩ, I <sub>DC_MAX</sub> : 9.6A
	C <sub>IN_3V</sub>	Capacitor	10 μF	CGA9N3X7R1H106K230KB	TDK	5.7 × 5.0 × 2.3	X7R, Rated voltage: 50 V <sub>DC</sub>
	C <sub>OUT_3V</sub>	Capacitor	47 μF × 10	CGA9N3X7R1C476M230KB	TDK	5.7 × 5.0 × 2.4	X7R, Rated voltage: 16 V <sub>DC</sub>
	M <sub>H</sub>	N-ch MOSFET	R <sub>ON_MAX</sub> : 32 mΩ	NVTFS5826NL	ON	3.3 × 3.3 × 0.75	V <sub>DS</sub> : 60V, I <sub>D</sub> : 10A
	M <sub>L</sub>	N-ch MOSFET	R <sub>ON_MAX</sub> : 32 mΩ	NVTFS5826NL	ON	3.3 × 3.3 × 0.75	V <sub>DS</sub> : 60V, I <sub>D</sub> : 10A
	C <sub>BST3V</sub>	Capacitor	0.1 μF	CGA3E2X7R1H104K080AA	TDK	1.6 × 0.8 × 0.8	X7R, Rated voltage: 50 V <sub>DC</sub>
R <sub>S</sub>	Resistor	10 mΩ	KRL2012-M-R010-F-T1	KOA	2.0 × 1.25 × 0.5	Rated power: 1W	
SW3V	CV <sub>OUT3V</sub>	Capacitor	22 μF	CGA6P1X7R1C226M250AC	TDK	3.2 × 1.6 × 1.6	X7R, Rated voltage: 16 V <sub>DC</sub>
DD5V	R <sub>H_FB5V</sub>	Resistor	2 MΩ (*3)	RK73H1JTTD2004F	KOA	1.6 × 0.8 × 0.45	Rated power: 0.1W
		Resistor	1.8 MΩ (*3)	RK73H1JTTD1804F	KOA	1.6 × 0.8 × 0.45	Rated power: 0.1W
	R <sub>L_FB5V</sub>	Resistor	1.2 MΩ (*3)	RK73H1JTTD1204F	KOA	1.6 × 0.8 × 0.45	Rated power: 0.1W
	C <sub>FB5V</sub>	Capacitor	3 pF	CGA3E2C0G1H030C080AA	TDK	1.6 × 0.8 × 0.8	C0G, Rated voltage: 50 V <sub>DC</sub>
	LL <sub>X5V</sub>	Inductor	1.5 μH	CLF6045NI-1R5N-D	TDK	7.4 × 7.0 × 4.8	DCR: 13 mΩ, I <sub>DC_MAX</sub> : 4.5A
	C <sub>IN_5V</sub>	Capacitor	4.7 μF	CGA4J3X7R1C475K125AB	TDK	2.0 × 1.2 × 1.25	X7R, Rated voltage: 16 V <sub>DC</sub>
CV <sub>OUT5V</sub>	Capacitor	47 μF × 5	CGA9N3X7R1C476M230KB	TDK	5.7 × 5.0 × 2.4	X7R, Rated voltage: 16 V <sub>DC</sub>	
HOT/ PG pins	R <sub>HOT</sub>	Resistor	100 kΩ	RK73H1JTTD1003F	KOA	1.6 × 0.8 × 0.45	Rated power: 0.1W
	R <sub>PG1V</sub>	Resistor	100 kΩ	RK73H1JTTD1003F	KOA	1.6 × 0.8 × 0.45	Rated power: 0.1W
	R <sub>PG3V</sub>	Resistor	100 kΩ	RK73H1JTTD1003F	KOA	1.6 × 0.8 × 0.45	Rated power: 0.1W
	R <sub>PG5V</sub>	Resistor	100 kΩ	RK73H1JTTD1003F	KOA	1.6 × 0.8 × 0.45	Rated power: 0.1W

Capacitor: Ceramic capacitor, SBD: Schottky barrier diode

\*1: V<sub>OUT1V</sub> setting ≈ 1.2V

\*2: V<sub>IN3V</sub> setting ≈ 3.3V

\*3: V<sub>OUT5V</sub> setting ≈ 5.0V

TDK: TDK Corporation

KOA: KOA Corporation

ON: ON Semiconductor Corporation

**Note:**

- The values of capacitors and resistors are subjects to consider according to a subsequent system. The values shown in the table are very dependable system whose current consumption varies dynamically from 0A to the full-load condition (maximum output current) in 10 μs.

## 10. Application Note

### 10.1 Setting the Operation Conditions

#### DD1V Output Voltage

The DD1V output voltage ( $V_{VOUT1V}$ ) of this IC can be adjusted by changing the external resistors connecting the FB1V pin.

Figure 10-1 DD1V Output Voltage Setting

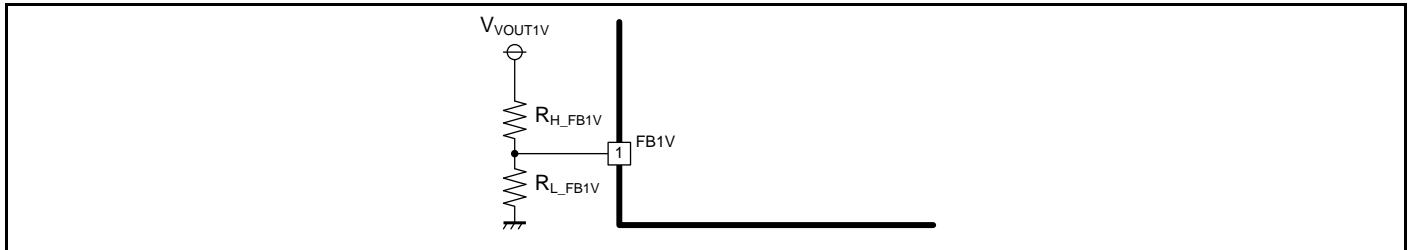

The DD1V output voltage ( $V_{VOUT1V}$ ) can be calculated using the formula below.

$$V_{VOUT1V} [V] = \frac{R_{H\_FB1V} + R_{L\_FB1V}}{R_{L\_FB1V}} \times V_{FB1V}$$

#### DD3V Output Voltage

The DD3V output voltage ( $V_{IN3V}$ ) of this IC can be adjusted by changing the external resistors connecting the FB3V pin.

Figure 10-2 DD3V Output Voltage Setting

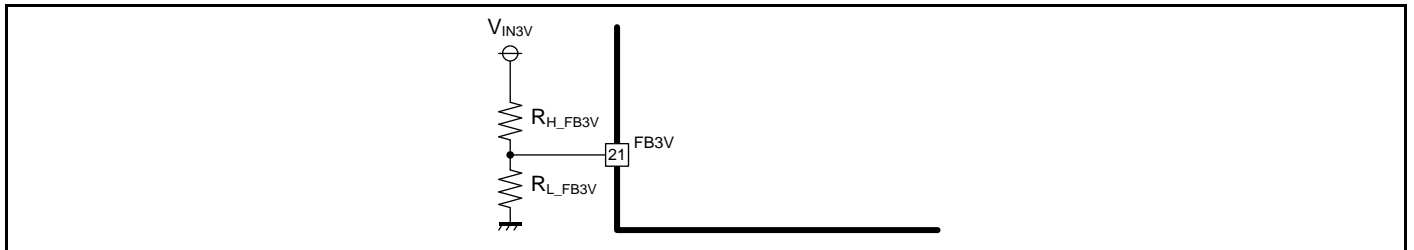

The DD3V output voltage ( $V_{IN3V}$ ) can be calculated using the formula below.

$$V_{IN3V} [V] = \frac{R_{H\_FB3V} + R_{L\_FB3V}}{R_{L\_FB3V}} \times V_{FB3V}$$

#### DD5V Output Voltage

The DD5V output voltage ( $V_{VOUT5V}$ ) of this IC can be adjusted by changing the external resistors connecting the FB5V pin.

Figure 10-3 DD5V Output Voltage Setting

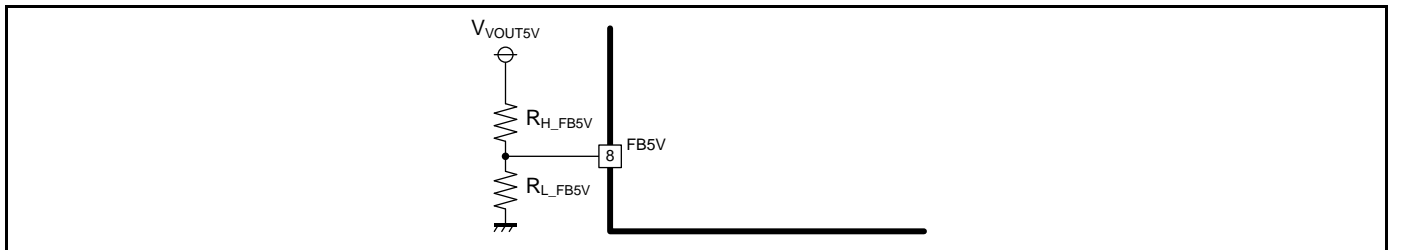

The DD5V output voltage ( $V_{VOUT5V}$ ) can be calculated using the formula below.

$$V_{VOUT5V} [V] = \frac{R_{H\_FB5V} + R_{L\_FB5V}}{R_{L\_FB5V}} \times V_{FB5V}$$

## C<sub>BST3V</sub> Capacitor

To drive the gate of the DD3V high-side FET (M<sub>H</sub>), the bootstrap capacitor (C<sub>BST3V</sub>) must have enough stored charge. The C<sub>BST3V</sub> capacitor is set to satisfy conditions of the following formula to hold electric charge above the threshold voltage (V<sub>FET</sub> [V]) of the high-side FET.

$$C_{BST3V} [F] \geq \frac{(6.79 \times 10^2 \times C_{OUT\_3V}^2 - 0.595 \times C_{OUT\_3V} + 280 \times 10^{-6}) \times C_{OUT\_3V}}{(5 - V_{FET}) \times \left(0.1 \times 10^{-3} + I_{OUT\_MIN5V} + \frac{V_{IN3V}}{R_{H\_FB3V} + R_{L\_FB3V}}\right) \times 10^3}$$

- C<sub>BST3V</sub> [F] : Bootstrap capacitor
  - C<sub>OUT\_3V</sub> [F] : DD3V output capacitor
  - V<sub>FET</sub> [V] : DD3V high-side FET threshold voltage
  - I<sub>OUT\_MIN5V</sub> [A] : DD5V output current
  - V<sub>IN3V</sub> [V] : DD3V output voltage
  - R<sub>H\_FB3V</sub> [Ω] : DD3V high-side output voltage setting resistor
  - R<sub>L\_FB3V</sub> [Ω] : DD3V low-side output voltage setting resistor
- (See [Figure 9-1 Application Circuit Example](#) for more information)

**Figure 10-4 C<sub>BST3V</sub> setting (C<sub>BST3V</sub> vs C<sub>OUT\_3V</sub>)**

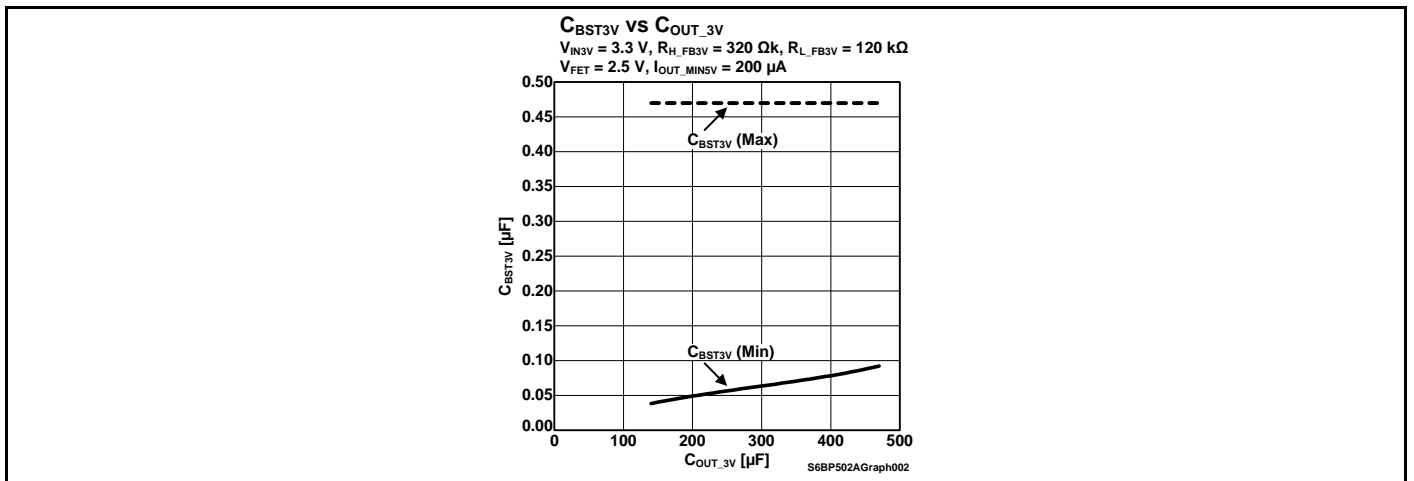

In addition, when the VIN voltage lowers down to the DD3V output voltage, the on-duty of the switching becomes 100% (D<sub>MAX\_3V</sub>) and the DD3V high-side FET keeps the turn-on state. The electric charge to the C<sub>BST3V</sub> capacitor is not performed in the turn-on state, then the gate voltage of the high-side FET cannot be maintained. Confirm that the time period during which the VIN voltage drops (below +3.7 V) is less than the high-side FET on-duration time (T<sub>ONDT</sub>). T<sub>ONDT</sub> can be calculated using the formula below.

$$T_{ONDT} [s] \geq \left\{1.675 - 2 \times \ln\left(\frac{1.34 + V_{FET}}{3.45}\right)\right\} \times C_{BST3V} \times 10^6$$

- T<sub>ONDT</sub> [s] : DD3V high-side FET On-duration time
- V<sub>FET</sub> [V] : DD3V high-side FET threshold voltage
- C<sub>BST3V</sub> [F] : Bootstrap capacitor

**Figure 10-5 High-side FET On-duration Time vs  $C_{BST3V}$**

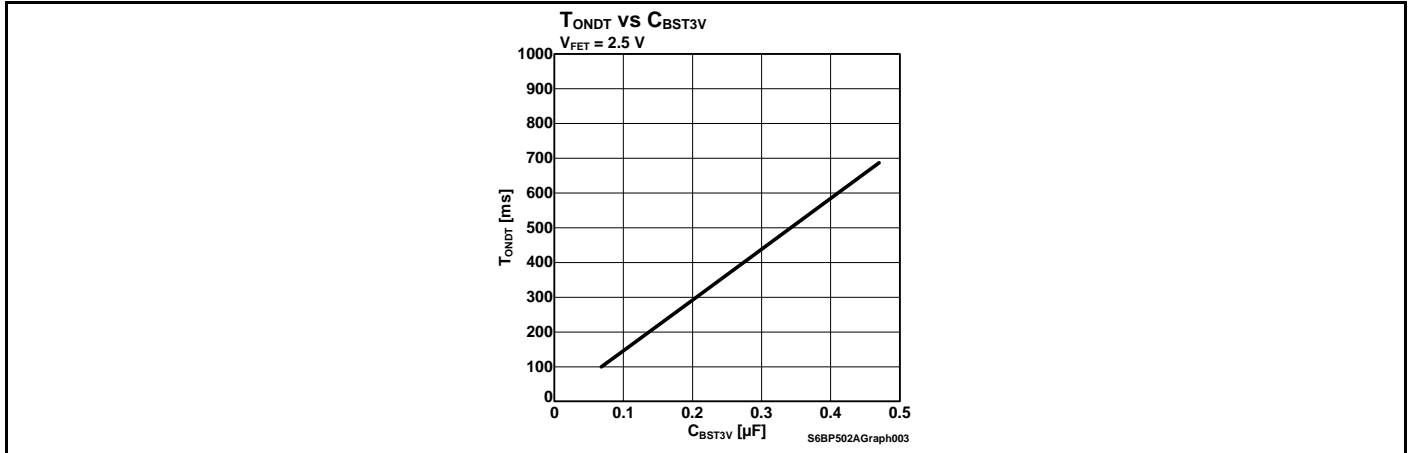



## 11. Reference Data

The following data are measured by an evaluation board mounting S6BP502A00SN2B000 under the conditions shown in "9. Application Circuit Example and Parts List". When measuring the efficiency, load regulation, line regulation and the temperature characteristics, the pull-up resistors,  $R_{PG1V}$ ,  $R_{PG3V}$ ,  $R_{PG5V}$  and  $R_{HOT}$ , are removed. Some data are measured under the condition of separated EN1V and EN3V for reference. However, EN1V and EN3V are recommended to be connected together.

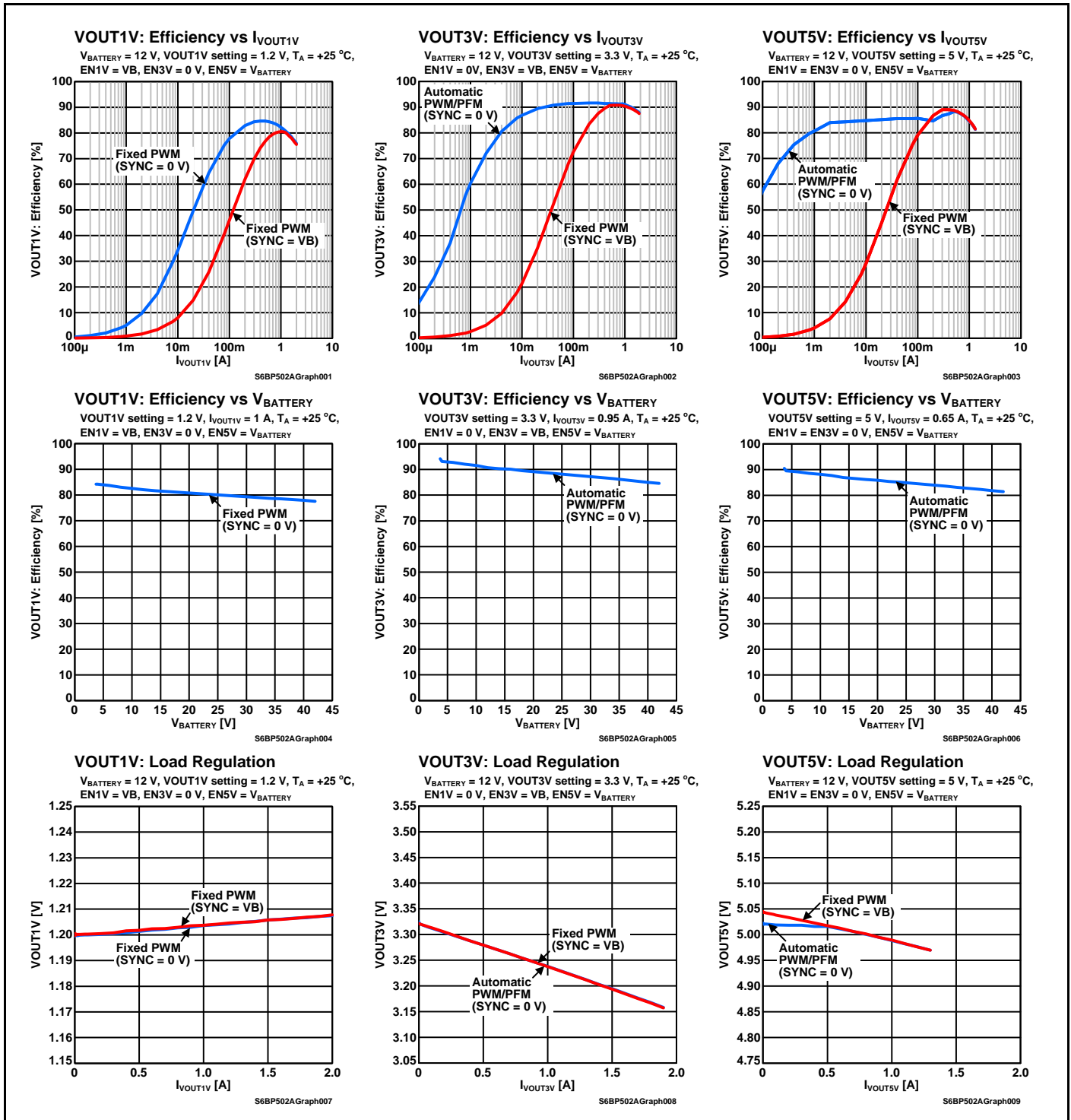

**VOUT1V: Line Regulation**

V<sub>BATTERY</sub> = 12 V, I<sub>VOUT1V</sub> = 1 A, T<sub>A</sub> = +25 °C,  
 EN1V = VB, EN3V = 0 V, EN5V = V<sub>BATTERY</sub>

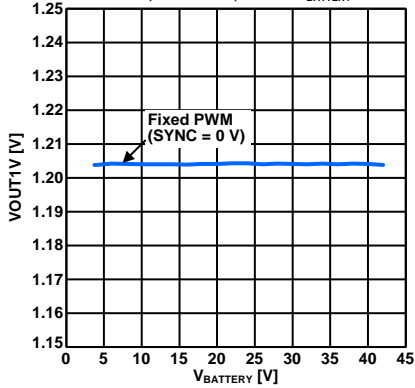

S6BP502AGraph010

**VOUT3V: Line Regulation**

VOUT3V setting = 3.3 V, I<sub>VOUT3V</sub> = 0.95 A, T<sub>A</sub> = +25 °C,  
 EN1V = 0 V, EN3V = VB, EN5V = V<sub>BATTERY</sub>

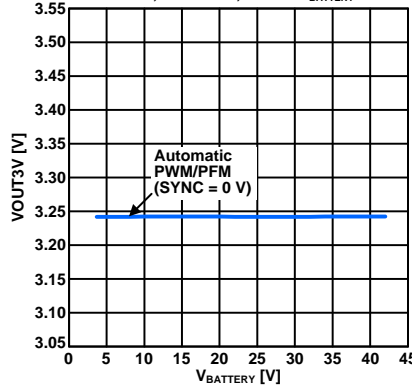

S6BP502AGraph011

**VOUT5V: Line Regulation**

VOUT5V setting = 5 V, I<sub>VOUT5V</sub> = 0.65 A, T<sub>A</sub> = +25 °C,  
 EN1V = EN3V = 0 V, EN5V = V<sub>BATTERY</sub>

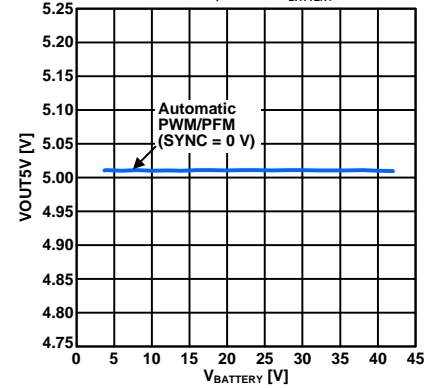

S6BP502AGraph012

**VOUT1V vs Ambient Temperature**

V<sub>BATTERY</sub> = 12 V, VOUT1V setting = 1.2 V, I<sub>VOUT1V</sub> = 1 A,  
 EN1V = VB, EN3V = 0 V, EN5V = V<sub>BATTERY</sub>

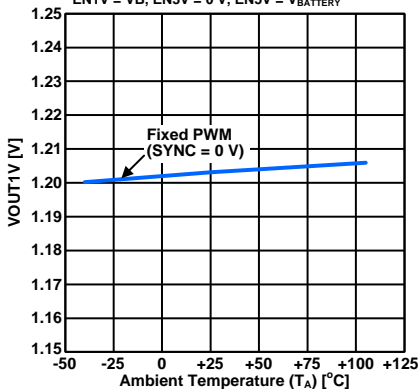

S6BP502AGraph013

**VOUT3V vs Ambient Temperature**

V<sub>BATTERY</sub> = 12 V, VOUT3V setting = 3.3 V, I<sub>VOUT3V</sub> = 0.95 A,  
 EN1V = 0 V, EN3V = VB, EN5V = V<sub>BATTERY</sub>

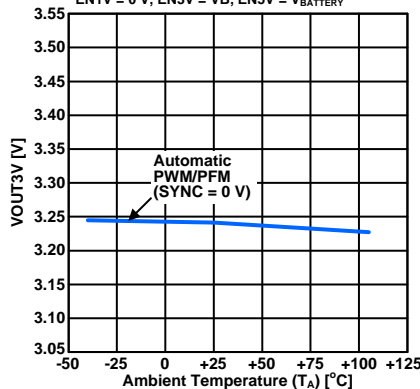

S6BP502AGraph014

**VOUT5V vs Ambient Temperature**

V<sub>BATTERY</sub> = 12 V, VOUT5V setting = 5 V, I<sub>VOUT5V</sub> = 0.65 A,  
 EN1V = EN3V = 0 V, EN5V = V<sub>BATTERY</sub>

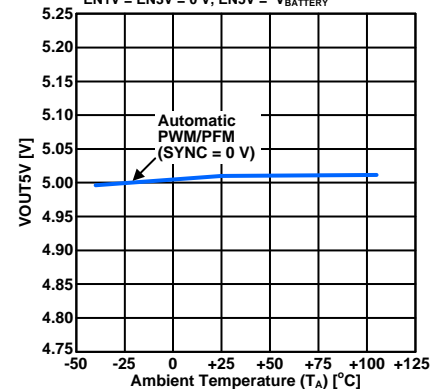

S6BP502AGraph015

**VOUT1V: Turn On Response**

V<sub>BATTERY</sub> = 12 V, I<sub>VOUT1V</sub> = I<sub>VOUT5V</sub> = 0 A, T<sub>A</sub> = +25 °C,  
 EN3V = EN1V, EN5V = V<sub>BATTERY</sub>,  
 SYNC = 0 V (DD1V: Fixed PWM)

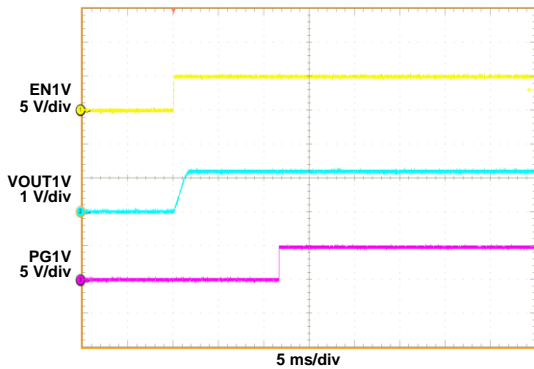

S6BP502AGraph016

**VOUT1V: Turn Off Response**

V<sub>BATTERY</sub> = 12 V, I<sub>VOUT1V</sub> = I<sub>VOUT5V</sub> = 0 A, T<sub>A</sub> = +25 °C,  
 EN3V = EN1V, EN5V = V<sub>BATTERY</sub>,  
 SYNC = 0 V (DD1V: Fixed PWM)

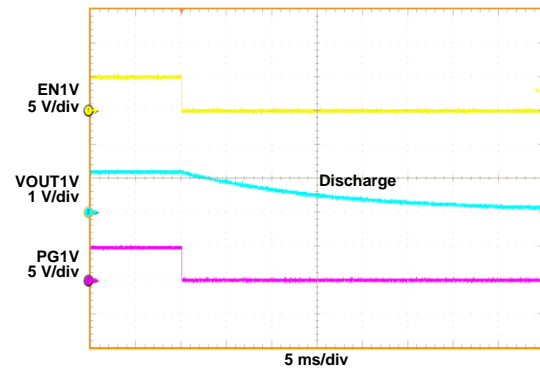

S6BP502AGraph017

### VOUT3V: Turn On Response

$V_{BATTERY} = 12\text{ V}$ ,  $I_{VOUT3V} = I_{VOUT5V} = 0\text{ A}$ ,  $T_A = +25\text{ }^\circ\text{C}$ ,  
 $EN1V = EN3V$ ,  $EN5V = V_{BATTERY}$ ,  
 $SYNC = 0\text{ V}$  (DD3V: Automatic PWM/PFM)

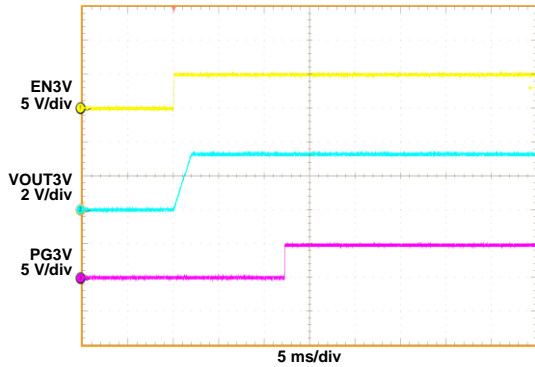

### VOUT3V: Turn Off Response

$V_{BATTERY} = 12\text{ V}$ ,  $I_{VOUT3V} = I_{VOUT5V} = 0\text{ A}$ ,  $T_A = +25\text{ }^\circ\text{C}$ ,  
 $EN1V = EN3V$ ,  $EN5V = V_{BATTERY}$ ,  
 $SYNC = 0\text{ V}$  (DD3V: Automatic PWM/PFM)

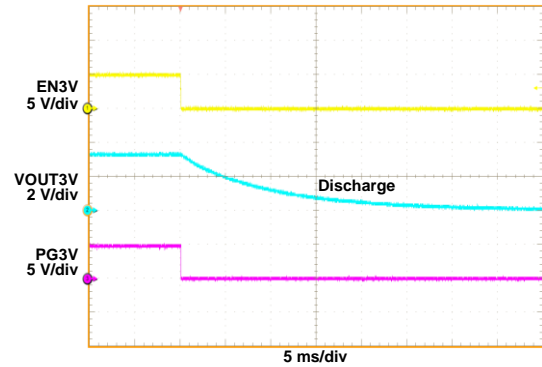

### VOUT5V: Turn On Response

$I_{VOUT5V} = 0\text{ A}$ ,  $T_A = +25\text{ }^\circ\text{C}$ ,  
 $EN1V = EN3V = 0\text{ V}$ ,  $EN5V = V_{BATTERY}$ ,  
 $SYNC = 0\text{ V}$  (DD5V: Automatic PWM/PFM)

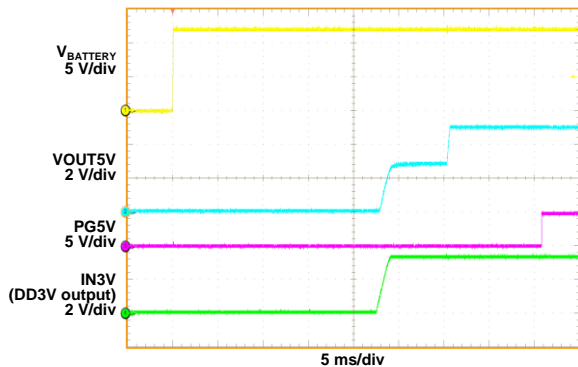

### VOUT5V: Turn Off Response

$I_{VOUT5V} = 0\text{ A}$ ,  $T_A = +25\text{ }^\circ\text{C}$ ,  
 $EN1V = EN3V = 0\text{ V}$ ,  $EN5V = V_{BATTERY}$ ,  
 $SYNC = 0\text{ V}$  (DD5V: Automatic PWM/PFM)

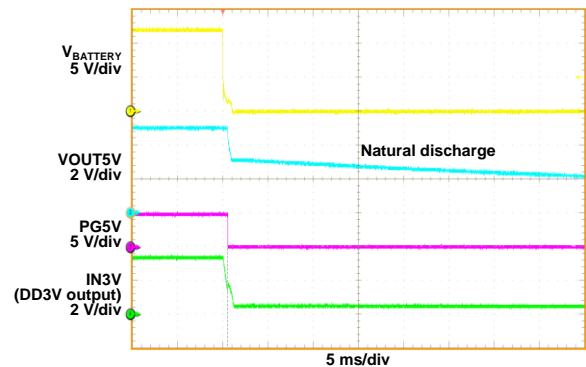

### LX3V Output Spectrum vs Frequency

$V_{BATTERY} = 12\text{ V}$ ,  $I_{VOUT3V} = 1.9\text{ A}$ ,  $I_{VOUT5V} = 0\text{ A}$ ,  
 $EN1V = 0\text{ V}$ ,  $EN3V = VB$ ,  $EN5V = V_{BATTERY}$ ,  
 $SYNC = 0\text{ V}$  (DD3V: Automatic PWM/PFM), RBW: 1 kHz, VBW: 100 kHz

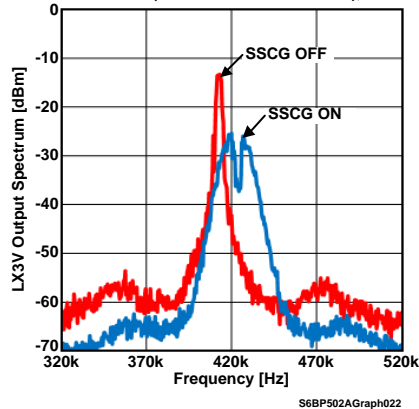

### LX1V: Switching Waveform

$V_{BATTERY} = 12\text{ V}$ ,  $I_{VOUT1V} = 2\text{ A}$ ,  $T_A = +25\text{ }^\circ\text{C}$ ,  
 $EN1V = EN3V = VB$ ,  $EN5V = V_{BATTERY}$ ,  
 $SYNC = 0\text{ V}$  (DD1V: Fixed PWM)

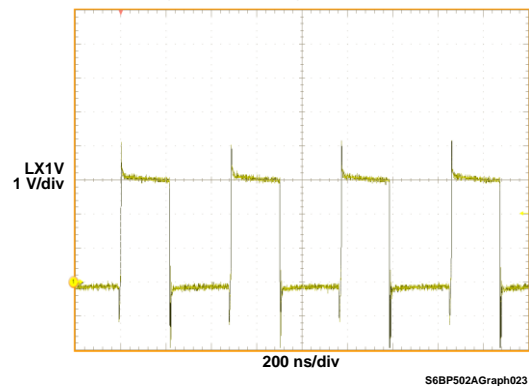

**LX3V: Switching Waveform**

$V_{BATTERY} = 12\text{ V}$ ,  $I_{VOUT3V} = 100\text{ mA}$ ,  $T_A = +25\text{ }^\circ\text{C}$ ,  
EN3V = EN1V = VB, EN5V =  $V_{BATTERY}$ ,  
SYNC = 0 V (DD3V: Automatic PWM/PFM)

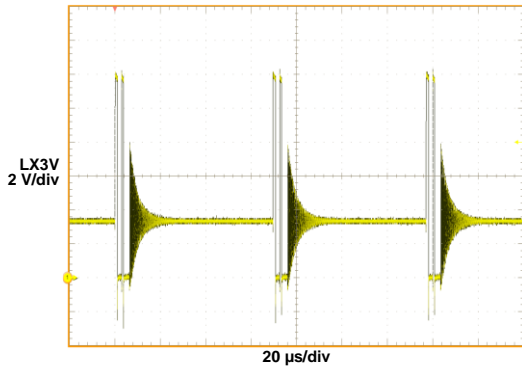

**LX3V: Switching Waveform**

$V_{BATTERY} = 12\text{ V}$ ,  $I_{VOUT3V} = 1.9\text{ A}$ ,  $T_A = +25\text{ }^\circ\text{C}$ ,  
EN3V = EN1V = VB, EN5V =  $V_{BATTERY}$ ,  
SYNC = 0 V (DD3V: Automatic PWM/PFM)

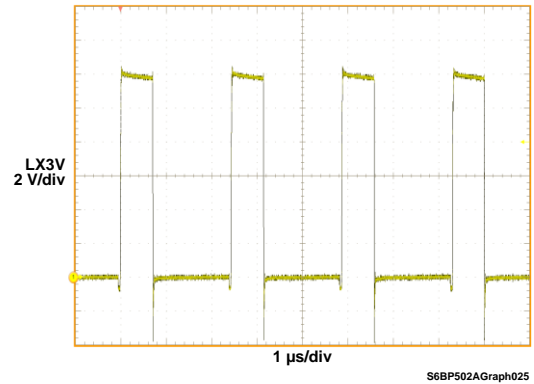

**LX5V: Switching Waveform**

$V_{BATTERY} = 12\text{ V}$ ,  $I_{VOUT5V} = 50\text{ mA}$ ,  $T_A = +25\text{ }^\circ\text{C}$ ,  
EN1V = EN3V = 0 V, EN5V =  $V_{BATTERY}$ ,  
SYNC = 0 V (DD5V: Automatic PWM/PFM)

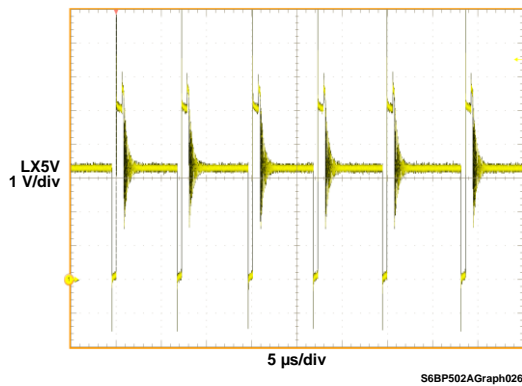

**LX5V: Switching Waveform**

$V_{BATTERY} = 12\text{ V}$ ,  $I_{VOUT5V} = 1.3\text{ A}$ ,  $T_A = +25\text{ }^\circ\text{C}$ ,  
EN1V = EN3V = 0 V, EN5V =  $V_{BATTERY}$ ,  
SYNC = 0 V (DD5V: Automatic PWM/PFM)

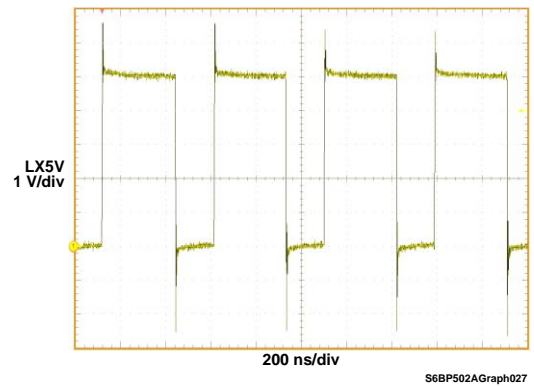

**VOUT1V: Ripple Waveform**

$V_{BATTERY} = 12\text{ V}$ ,  $I_{VOUT1V} = 2\text{ A}$ ,  $I_{VOUT3V} = I_{VOUT5V} = 0\text{ A}$ ,  $T_A = +25\text{ }^\circ\text{C}$ ,  
EN1V = EN3V = VB, EN5V =  $V_{BATTERY}$ ,  
SYNC = 0 V (DD1V: Fixed PWM)

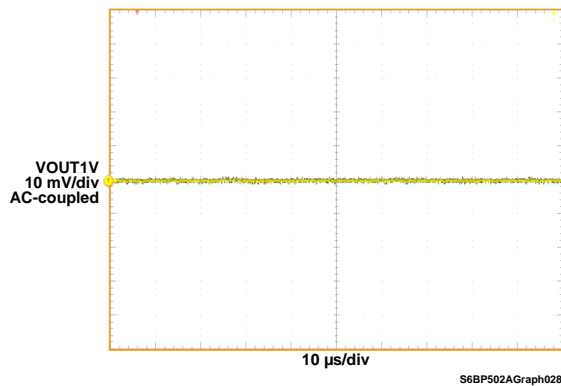

**VOUT3V: Ripple Waveform**

$V_{BATTERY} = 12\text{ V}$ ,  $I_{VOUT1V} = 0\text{ A}$ ,  $I_{VOUT3V} = 1.9\text{ A}$ ,  $I_{VOUT5V} = 0\text{ A}$ ,  $T_A = +25\text{ }^\circ\text{C}$ ,  
EN1V = EN3V = VB, EN5V =  $V_{BATTERY}$ ,  
SYNC = 0 V (DD3V: Automatic PWM/PFM)

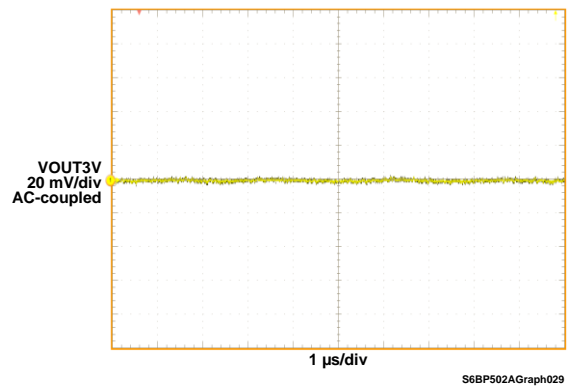

### VOUT5V: Ripple Waveform

$V_{BATTERY} = 12\text{ V}$ ,  $I_{VOUT1V} = I_{VOUT3V} = 0\text{ A}$ ,  $I_{VOUT5V} = 1.3\text{ A}$ ,  $T_A = +25\text{ }^\circ\text{C}$ ,  
 $EN1V = EN3V = VB$ ,  $EN5V = V_{BATTERY}$ ,  
 $SYNC = 0\text{ V}$  (DD5V: Automatic PWM/PFM)

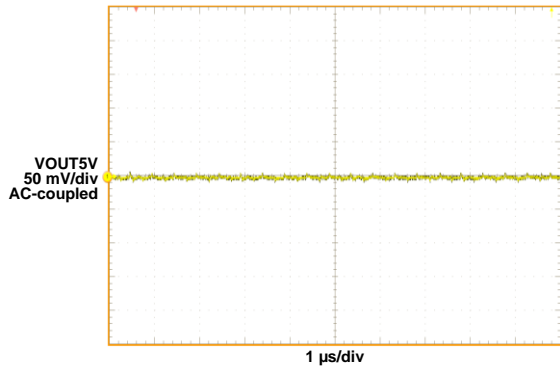

### VOUT1V, VOUT3V, VOUT5V: Ripple Waveform

$V_{BATTERY} = 12\text{ V}$ ,  $I_{VOUT1V} = I_{VOUT3V} = I_{VOUT5V} = 0\text{ A}$ ,  $T_A = +25\text{ }^\circ\text{C}$ ,  
 $EN1V = EN3V = VB$ ,  $EN5V = V_{BATTERY}$ ,  
 $SYNC = 0\text{ V}$  (DD1V: Fixed PWM, DD3V & DD5V: Automatic PWM/PFM)

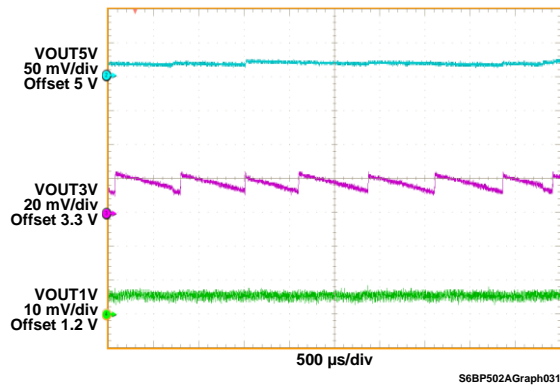

### VOUT1V, VOUT3V, VOUT5V: Ripple Waveform

$V_{BATTERY} = 12\text{ V}$ ,  $I_{VOUT1V} = I_{VOUT3V} = I_{VOUT5V} = 0\text{ A}$ ,  $T_A = +25\text{ }^\circ\text{C}$ ,  
 $EN1V = EN3V = VB$ ,  $EN5V = V_{BATTERY}$ ,  
 $SYNC = VB$  (DD1V & DD3V & DD5V: Fixed PWM)

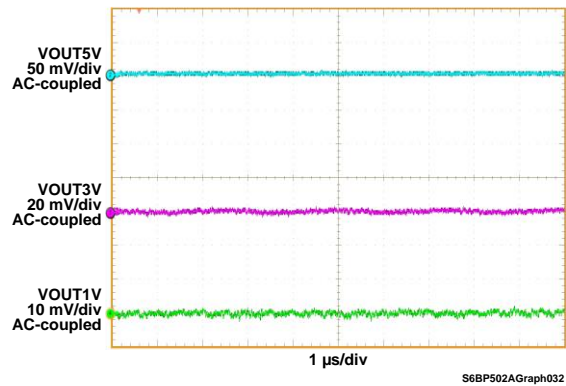

### VOUT1V: Load Transient Response

$V_{BATTERY} = 12\text{ V}$ ,  $I_{VOUT3V} = I_{VOUT5V} = 0\text{ A}$ ,  $T_A = +25\text{ }^\circ\text{C}$ ,  
 $EN1V = EN3V = VB$ ,  $EN5V = V_{BATTERY}$ ,  
 $SYNC = 0\text{ V}$  (DD1V: Fixed PWM)

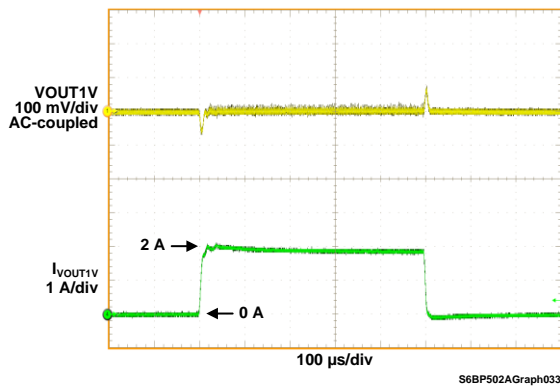

### VOUT3V: Load Transient Response

$V_{BATTERY} = 12\text{ V}$ ,  $I_{VOUT1V} = I_{VOUT5V} = 0\text{ A}$ ,  $T_A = +25\text{ }^\circ\text{C}$ ,  
 $EN1V = EN3V = VB$ ,  $EN5V = V_{BATTERY}$ ,  
 $SYNC = 0\text{ V}$  (DD3V: Automatic PWM/PFM)

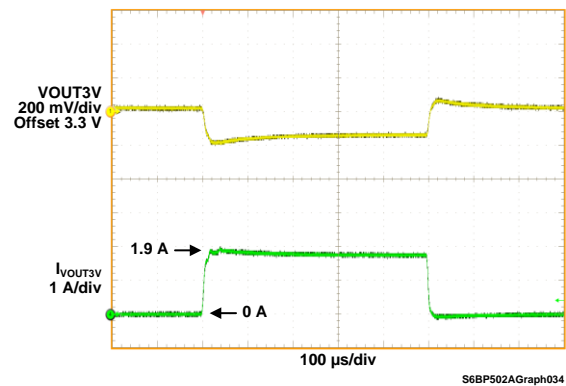

### VOUT5V: Load Transient Response

$V_{BATTERY} = 12\text{ V}$ ,  $I_{VOUT1V} = I_{VOUT3V} = 0\text{ A}$ ,  $T_A = +25\text{ }^\circ\text{C}$ ,  
 $EN1V = EN3V = VB$ ,  $EN5V = V_{BATTERY}$ ,  
 $SYNC = 0\text{ V}$  (DD5V: Automatic PWM/PFM)

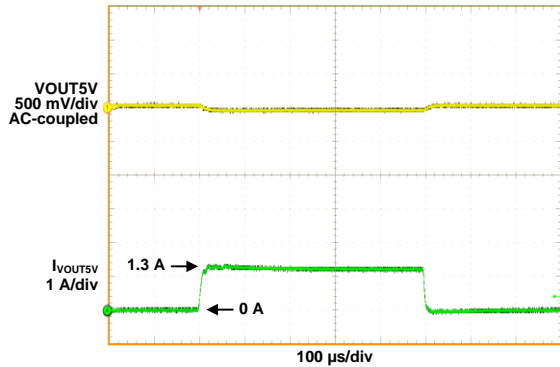

### VOUT1V, VOUT3V, VOUT5V: Line Transient Response

$I_{VOUT1V} = 1\text{ A}$ ,  $I_{VOUT3V} = 0.95\text{ A}$ ,  $I_{VOUT5V} = 0.65\text{ A}$ ,  $T_A = +25\text{ }^\circ\text{C}$ ,  
 $EN1V = EN3V = VB$ ,  $EN5V = V_{BATTERY}$ ,  
 $SYNC = 0\text{ V}$  (DD1V: Fixed PWM, DD3V & DD5V: Automatic PWM/PFM)

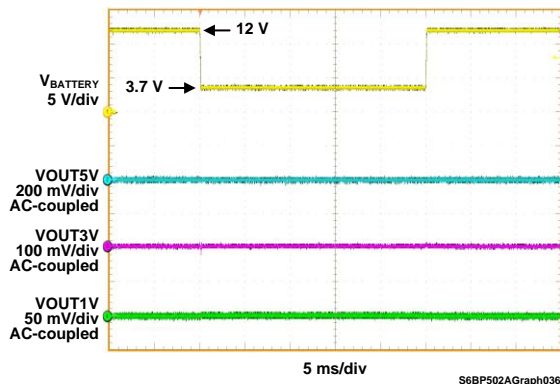

### VOUT1V, VOUT3V, VOUT5V: Line Transient Response

$I_{VOUT1V} = 1\text{ A}$ ,  $I_{VOUT3V} = 0.95\text{ A}$ ,  $I_{VOUT5V} = 0.65\text{ A}$ ,  $T_A = +25\text{ }^\circ\text{C}$ ,  
 $EN1V = EN3V = VB$ ,  $EN5V = V_{BATTERY}$ ,  
 $SYNC = 0\text{ V}$  (DD1V: Fixed PWM, DD3V & DD5V: Automatic PWM/PFM)

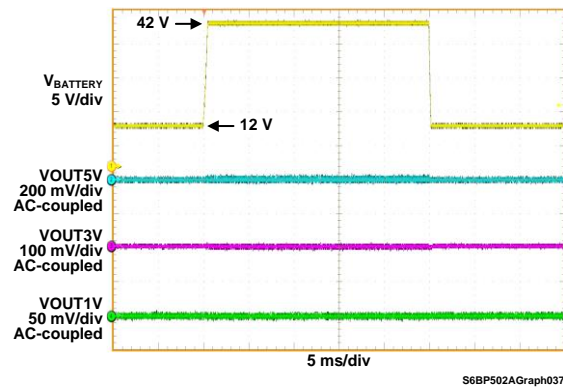

### DD1V: Over Current Protection Waveform

$V_{BATTERY} = 12\text{ V}$ ,  $I_{VOUT5V} = 0\text{ A}$ ,  $T_A = +25\text{ }^\circ\text{C}$ ,  
 $EN1V = EN3V = VB$ ,  $EN5V = V_{BATTERY}$ ,  
 $SYNC = 0\text{ V}$  (DD1V: Fixed PWM)

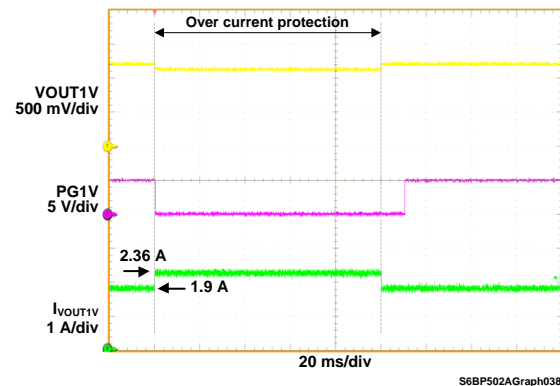

### DD1V: Gain, Phase Characteristics

$V_{BATTERY} = 12\text{ V}$ ,  $I_{VOUT1V} = 2\text{ A}$ ,  $I_{VOUT5V} = 0\text{ A}$ ,  $T_A = +25\text{ }^\circ\text{C}$ ,  
 $EN1V = VB$ ,  $EN3V = 0\text{ V}$ ,  $EN5V = V_{BATTERY}$ ,  
 $SYNC = 0\text{ V}$  (DD1V: Fixed PWM)

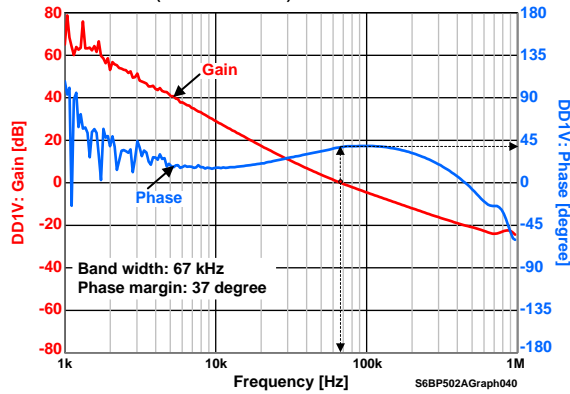

### DD3V: Gain, Phase Characteristics

$V_{BATTERY} = 12\text{ V}$ ,  $I_{VOUT3V} = 1.9\text{ A}$ ,  $I_{VOUT5V} = 0\text{ A}$ ,  $T_A = +25\text{ }^\circ\text{C}$ ,  
 $EN1V = 0\text{ V}$ ,  $EN3V = VB$ ,  $EN5V = V_{BATTERY}$ ,  
 $SYNC = 0\text{ V}$  (DD3V: Automatic PWM/PFM)

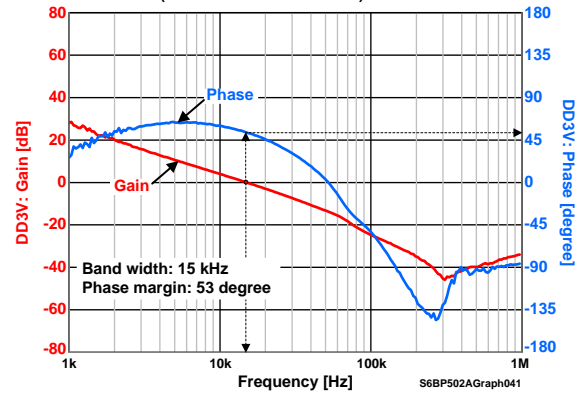

### DD5V: Gain, Phase Characteristics

$V_{BATTERY} = 12\text{ V}$ ,  $I_{VOUT5V} = 1.3\text{ A}$ ,  $T_A = +25\text{ }^\circ\text{C}$ ,  
 $EN1V = EN3V = 0\text{ V}$ ,  $EN5V = V_{BATTERY}$ ,  
 $SYNC = 0\text{ V}$  (DD5V: Automatic PWM/PFM)

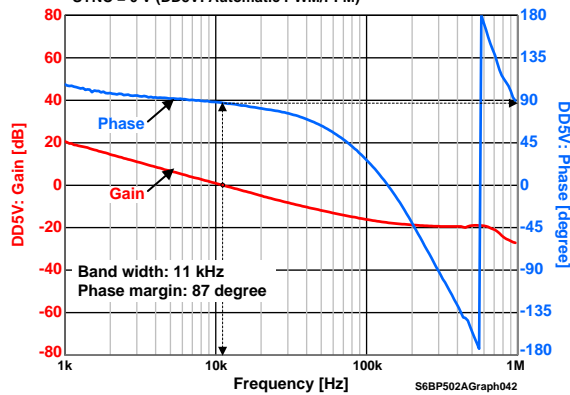

## 12. Usage Precaution

Printed circuit board ground lines should be set up with consideration for common impedance.

### Take appropriate measures against static electricity.

- Containers for semiconductor materials should have anti-static protection or be made of conductive material.
- After mounting, printed circuit boards should be stored and shipped in conductive bags or containers.
- Work platforms, tools, and instruments should be properly grounded.
- Working personnel should be grounded with resistance of 250 kΩ to 1 MΩ in serial body and ground.

### Do not apply negative voltages.

The use of negative voltages below -0.3 V may make the parasitic transistor activated to the LSI, and can cause malfunctions.

## 13. RoHS Compliance Information

This product has observed the standard of lead, cadmium, mercury, Hexavalent chromium, polybrominated biphenyls (PBB), and polybrominated diphenyl ethers (PBDE).

## 14. Ordering Information

Part Number (MPN)	Package
S6BP501A00SN2B000	Plastic, Wettable QFN (0.50 mm pitch), 32-pin (VNG032)
S6BP502A00SN2B000	

MPN: Marketing Part Number

Figure 14-1 Ordering Part Number Definitions

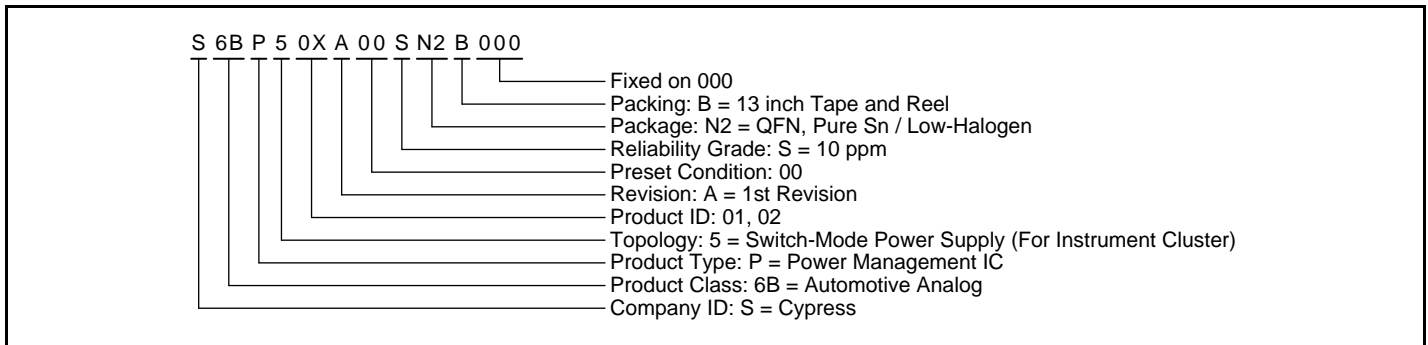



## 15. Package Dimensions

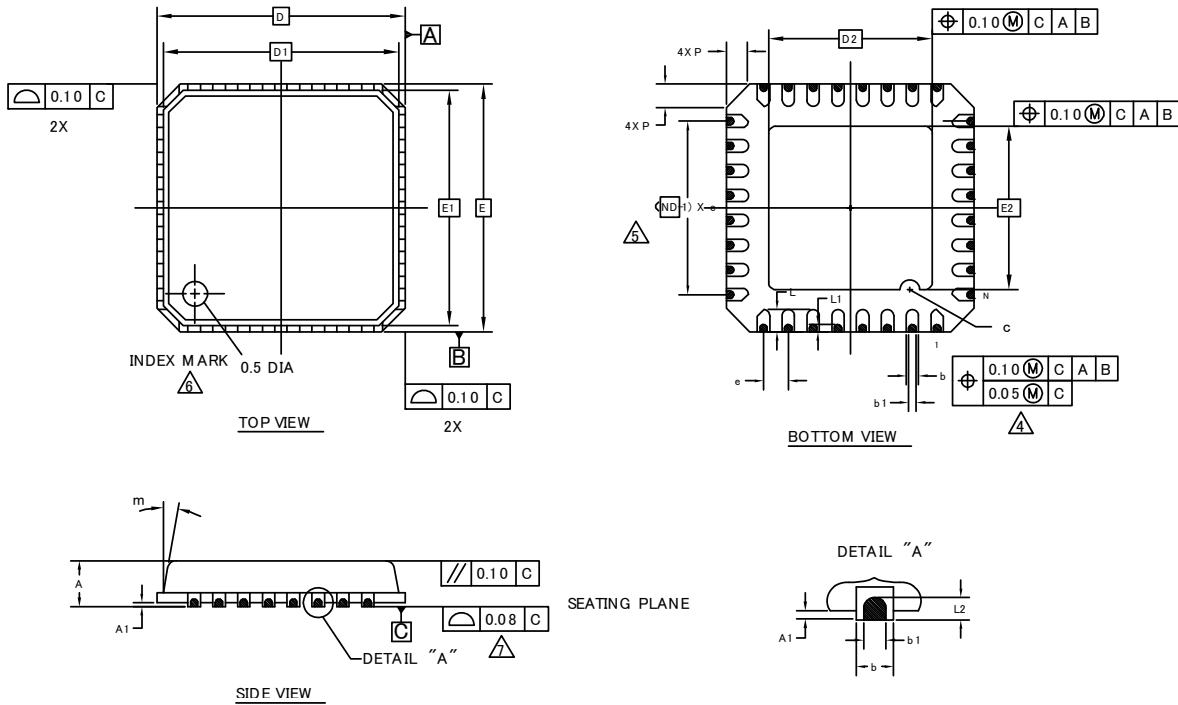

SYMBOL	DIMENSIONS			NOTE
	MIN.	NOM.	MAX.	
A	—	—	0.90	PROFILE
A1	0.00	—	0.05	
D	5.00 BSC			
E	5.00 BSC			
D1	4.75 BSC			
E1	4.75 BSC			
b	0.18	0.25	0.30	TERMINAL WIDTH
b1	0.10	0.15	0.20	DIMPLE WIDTH
D2	3.30 BSC			EXPOSED PAD SIZE
E2	3.30 BSC			EXPOSED PAD SIZE
e	0.50 BSC			TERMINAL PITCH
L	0.35	0.45	0.55	TERMINAL LENGTH
L1	0.05	0.15	0.25	DIMPLE LENGTH
L2	0.09 REF			DIMPLE HEIGHT
c	R0.20			PIN #1 ID
m	0	—	12°	
P	—	—	0.60	
N	32			TERMINAL COUNT

### NOTES

- ALL DIMENSIONS ARE IN MILLIMETERS.
- DIMENSIONING AND TOLERANCING CONFORMS TO ASME Y14.5-1994.
- N IS THE TOTAL NUMBER OF TERMINALS.
- DIMENSION "b" APPLIES TO METALLIZED TERMINAL AND IS MEASURED BETWEEN 0.15 AND 0.30mm FROM TERMINAL TIP. IF THE TERMINAL HAS THE OPTIONAL RADIUS ON THE OTHER END OF THE TERMINAL THE DIMENSION "b" SHOULD NOT BE MEASURED IN THAT RADIUS AREA.
- ND REFER TO THE NUMBER OF TERMINALS ON D OR E SIDE.
- PIN #1 ID ON TOP WILL BE LOCATED WITHIN INDICATED ZONE.
- UNILATERAL COPLANARITY ZONE APPLIES TO THE EXPOSED HEAT SINK SLUG AS WELL AS THE TERMINALS.

002-13490 Rev. \*\*

PACKAGE OUTLINE, 32 LEAD W QFN  
5.0X5.0X0.9 MM VNG032 3.3X3.3 MM EPAD (SAWN) REV\*\*

## Document History

Document Title: **S6BP501A, S6BP502A 3ch DC/DC Converter IC for Automotive Cluster**

Document Number: 002-03396

Revision	ECN	Submission Date	Description of Change
**	4921966	09/16/2015	New Spec.
*A	4998578	11/02/2015	Added Errata.
*B	5107300	01/26/2016	<p>Updated the description for the pin name, IN3V in the <a href="#">Table 3-1</a>.            Updated the following <a href="#">Electrical Characteristics</a>.</p> <p>I<sub>LEAK_1V</sub>: Condition            I<sub>LXPEAK_1V</sub>: Min values            t<sub>SS_3V</sub>: Typ value            R<sub>ONH_3V</sub>: Typ value            R<sub>ON_BSTSW</sub>: Typ and Max values            I<sub>R_BSTSW</sub>: Condition and Max value            I<sub>LOAD_SW3V</sub>: Min values            I<sub>LEAK_SW3V</sub>: Condition            t<sub>SS_SW3V</sub>: Typ value            I<sub>PWMPPM_5V</sub>: Typ value            I<sub>LEAK_5V</sub>: Condition            I<sub>LX_PEA5V</sub>: Typ value            V<sub>OVDF_PG1V</sub>: Typ value            SSCG block (Modulation range): Typ value</p> <p>Updated the description and the <a href="#">Table 8-2</a> of the SYNC in the Section 8.2.            Added the remarks for the DD5V output in the <a href="#">Table 8-3</a>.            Updated the following parts in the <a href="#">Table 9-1</a>..</p> <p>C<sub>VDD</sub>: value, part number and remarks            R<sub>H_FB3V</sub>: value and part number            R<sub>L_FB3V</sub>: value and part number            R<sub>S</sub>: value</p> <p>Added "Development Support"            Updated Errata.</p>
*C	5198555	05/16/2016	<p>Added "AEC-Q100 compliant (Grade-2)" in <a href="#">Features</a>.            Updated <a href="#">Architecture Block Diagram</a>.            Deleted Errata item1, item2, item4, and item5 from <a href="#">Errata</a>.            Errata item3 in <a href="#">Errata</a> is under confirmation with Rev.2 silicon.</p>
*D	5325274	09/09/2016	<p>Added <a href="#">Block Diagram</a>            Added <a href="#">More Information</a>            Updated the values in <a href="#">Electrical Characteristics</a></p> <p>DD3V block: Boost switch</p> <p>R<sub>ONH_3V</sub>: Condition (DRVH3V pin current = 50 mA → 10 mA),            Typ value (8.5Ω → 15Ω)            R<sub>ON_BSTSW</sub>: Typ value (3Ω → 8Ω), Max value (10Ω → 24Ω)            I<sub>R_BSTSW</sub>: Max value (3 μA → 2 μA)</p> <p>Deleted "Development Support"            Added <a href="#">Figure 14-1 Ordering Part Number Definitions</a>            Deleted <a href="#">Errata</a></p>

Revision	ECN	Submission Date	Description of Change
*E	5522611	11/18/2016	<p>Updated the values in <a href="#">Electrical Characteristics</a></p> <p>Supply current:  <math>I_{SHDN}</math>: Added Max value (2 <math>\mu</math>A)  <math>I_{VB}</math>: Added Max value (25 mA)</p> <p>DD1V block:  <math>R_{ONH\_1V}</math>: Added Max value (260 m<math>\Omega</math>)  <math>R_{ONL\_1V}</math>: Added Max value (200 m<math>\Omega</math>)  <math>R_{DIS\_1V}</math>: Added Min value (280<math>\Omega</math>), Added Max value (520<math>\Omega</math>)  <math>t_{SS\_1V}</math>: Added Min value (0.5 ms), Added Max value (2 ms)</p> <p>DD3V block:  <math>t_{SS\_3V}</math>: Added Min value (0.5 ms), Added Max value (2 ms)  <math>R_{ONH\_3V}</math>: Added Max value (30 <math>\Omega</math>)  <math>R_{ONL\_3V}</math>: Added Max value (3 <math>\Omega</math>)  <math>R_{ONH\_3V}</math>: Added Max value (4 <math>\Omega</math>)  <math>R_{ONL\_3V}</math>: Added Max value (2 <math>\Omega</math>)  <math>R_{DIS\_3V}</math>: Added Min value (280<math>\Omega</math>), Added Max value (520<math>\Omega</math>)  <math>t_{SS\_3V}</math>: Added Min value (1 ms), Added Max value (4 ms)</p> <p>DD5V block:  <math>R_{ONH\_5V}</math>: Added Max value (260 m<math>\Omega</math>)  <math>R_{ONL\_5V}</math>: Added Max value (200 m<math>\Omega</math>)  <math>t_{SS\_5V}</math>: Added Min value (0.2 ms), Added Max value (1 ms)</p> <p>EN1V pin: <math>I_{ON\_EN1V}</math>: Added Max value (100 <math>\mu</math>A)  EN3V pin: <math>I_{ON\_EN3V}</math>: Added Max value (100 <math>\mu</math>A)  EN5V pin: <math>I_{OFF\_EN5V}</math>: Added Max value (1 <math>\mu</math>A)  SYNC Pin / SYNC block: <math>I_{IN\_SYNC}</math>: Added Max value (100 <math>\mu</math>A)  SSCG block:  Modulation range: Added Min value (3 %), Added Max value (9%)  <math>F_{MOD}</math>: Added comments in condition.  Added Min value (3 kHz), Added Max value (5 kHz)</p> <p>Updated <a href="#">Figure 8-1 Turn On and Turn Off Sequence</a>  Added a comment "Start-up initialization is complete".</p>
*F	5626998	02/13/2017	<p>Changed the values in <a href="#">Electrical Characteristics</a></p> <p>OSC block: Switching frequency  <math>F_{OSC1}</math>: Changed Min value (2.0 MHz <math>\rightarrow</math> 1.9 MHz)  Changed Max value (2.2 MHz <math>\rightarrow</math> 2.3 MHz)  <math>F_{OSC2}</math>: Changed Min value (0.40 MHz <math>\rightarrow</math> 0.38 MHz)  Changed Max value (0.44 MHz <math>\rightarrow</math> 0.46 MHz)</p> <p>Added the setting of <math>C_{BST3V}</math> Capacitor in <a href="#">Application Note</a></p>
*G	5764719	06/20/2017	<p>Updated <a href="#">Block Diagram</a>  Corrected a typo (FET symbol of the load switch): "NMOS" <math>\rightarrow</math> "PMOS"</p> <p>Updated <a href="#">Architecture Block Diagram</a>  Corrected a typo (FET symbol of the load switch): "NMOS" <math>\rightarrow</math> "PMOS"</p> <p>Updated <a href="#">Absolute Maximum Ratings</a>  Corrected a typo (Symbol of "DRVL3V to PGND3V" at the difference voltage):  "<math>V_{DRVH3V\_LX3V}</math>" <math>\rightarrow</math> "<math>V_{DRVL3V\_PGND3V}</math>"</p> <p>Updated the conditions in <a href="#">Electrical Characteristics</a>  DD1V block, <math>V_{OVPF\_1V}</math>: Added "Monitoring <math>V_{LX1V}</math> falling"  DD3V block, <math>V_{OVPR\_3V}</math>: Changed "Monitoring <math>V_{VOUT3V}</math> rising" <math>\rightarrow</math> "Monitoring <math>V_{CSN}</math> rising"  DD3V block, <math>V_{OVPF\_3V}</math>: Added "Monitoring <math>V_{IN3V}</math> falling"  DD3V block, <math>R_{ONL\_3V}</math>: Corrected a typo ("PLX3V to DRVL3V") <math>\rightarrow</math> ("LX3V to DRVL3V")  DD5V block, <math>V_{OVPF\_5V}</math>: Added "Monitoring <math>V_{VOUT5V}</math> falling"  PG1V pin, <math>I_{LEAK\_PG1V}</math>: Corrected a typo "<math>V_{PG5V} = 5.0</math> V" <math>\rightarrow</math> "<math>V_{PG1V} = 5.0</math> V"  PG1V pin, <math>V_{LOW\_PG1V}</math>: Corrected a typo "<math>I_{PG5V} = 3</math> mA" <math>\rightarrow</math> "<math>I_{PG1V} = 3</math> mA"</p> <p>Added <a href="#">Figure 3-1 I/O Pin Equivalent Circuit Diagram</a>  Added <a href="#">Reference Data</a>  Deleted the part number of the engineering part number from <a href="#">Ordering Information</a></p>
*H	6283945	08/17/2018	No update due to sunset review

Revision	ECN	Submission Date	Description of Change
*1	6957023	09/01/2020	To recommend connecting EN1V and EN3V together. Updated Table 3-1 Pin Descriptions Updated Figure 8-1 Turn On and Turn Off Sequence Updated Table 8-3 Switching signals to be inputted to the SYNC pin Updated Table 8-4 Output State and Protection Function Table Updated Figure 9-1 Application Circuit Example Updated Reference Data

## Sales, Solutions, and Legal Information

### Worldwide Sales and Design Support

Cypress maintains a worldwide network of offices, solution centers, manufacturer's representatives, and distributors. To find the office closest to you, visit us at [Cypress Locations](#).

#### Products

Arm® Cortex® Microcontrollers	<a href="http://cypress.com/arm">cypress.com/arm</a>
Automotive	<a href="http://cypress.com/automotive">cypress.com/automotive</a>
Clocks & Buffers	<a href="http://cypress.com/clocks">cypress.com/clocks</a>
Interface	<a href="http://cypress.com/interface">cypress.com/interface</a>
Internet of Things	<a href="http://cypress.com/iot">cypress.com/iot</a>
Memory	<a href="http://cypress.com/memory">cypress.com/memory</a>
Microcontrollers	<a href="http://cypress.com/mcu">cypress.com/mcu</a>
PSoC	<a href="http://cypress.com/psoc">cypress.com/psoc</a>
Power Management ICs	<a href="http://cypress.com/pmic">cypress.com/pmic</a>
Touch Sensing	<a href="http://cypress.com/touch">cypress.com/touch</a>
USB Controllers	<a href="http://cypress.com/usb">cypress.com/usb</a>
Wireless Connectivity	<a href="http://cypress.com/wireless">cypress.com/wireless</a>

#### PSoC® Solutions

[PSoC 1](#) | [PSoC 3](#) | [PSoC 4](#) | [PSoC 5LP](#) | [PSoC 6 MCU](#)

#### Cypress Developer Community

[Community](#) | [Code Examples](#) | [Projects](#) | [Videos](#) | [Blogs](#) | [Training](#) | [Components](#)

#### Technical Support

[cypress.com/support](http://cypress.com/support)

Arm and Cortex are registered trademarks of Arm Limited (or its subsidiaries) in the US and/or elsewhere.

© Cypress Semiconductor Corporation, 2015-2020. This document is the property of Cypress Semiconductor Corporation and its subsidiaries ("Cypress"). This document, including any software or firmware included or referenced in this document ("Software"), is owned by Cypress under the intellectual property laws and treaties of the United States and other countries worldwide. Cypress reserves all rights under such laws and treaties and does not, except as specifically stated in this paragraph, grant any license under its patents, copyrights, trademarks, or other intellectual property rights. If the Software is not accompanied by a license agreement and you do not otherwise have a written agreement with Cypress governing the use of the Software, then Cypress hereby grants you a personal, non-exclusive, nontransferable license (without the right to sublicense) (1) under its copyright rights in the Software (a) for Software provided in source code form, to modify and reproduce the Software solely for use with Cypress hardware products, only internally within your organization, and (b) to distribute the Software in binary code form externally to end users (either directly or indirectly through resellers and distributors), solely for use on Cypress hardware product units, and (2) under those claims of Cypress's patents that are infringed by the Software (as provided by Cypress, unmodified) to make, use, distribute, and import the Software solely for use with Cypress hardware products. Any other use, reproduction, modification, translation, or compilation of the Software is prohibited.

TO THE EXTENT PERMITTED BY APPLICABLE LAW, CYPRESS MAKES NO WARRANTY OF ANY KIND, EXPRESS OR IMPLIED, WITH REGARD TO THIS DOCUMENT OR ANY SOFTWARE OR ACCOMPANYING HARDWARE, INCLUDING, BUT NOT LIMITED TO, THE IMPLIED WARRANTIES OF MERCHANTABILITY AND FITNESS FOR A PARTICULAR PURPOSE. No computing device can be absolutely secure. Therefore, despite security measures implemented in Cypress hardware or software products, Cypress shall have no liability arising out of any security breach, such as unauthorized access to or use of a Cypress product. CYPRESS DOES NOT REPRESENT, WARRANT, OR GUARANTEE THAT CYPRESS PRODUCTS, OR SYSTEMS CREATED USING CYPRESS PRODUCTS, WILL BE FREE FROM CORRUPTION, ATTACK, VIRUSES, INTERFERENCE, HACKING, DATA LOSS OR THEFT, OR OTHER SECURITY INTRUSION (collectively, "Security Breach"). Cypress disclaims any liability relating to any Security Breach, and you shall and hereby do release Cypress from any claim, damage, or other liability arising from any Security Breach. In addition, the products described in these materials may contain design defects or errors known as errata which may cause the product to deviate from published specifications. To the extent permitted by applicable law, Cypress reserves the right to make changes to this document without further notice. Cypress does not assume any liability arising out of the application or use of any product or circuit described in this document. Any information provided in this document, including any sample design information or programming code, is provided only for reference purposes. It is the responsibility of the user of this document to properly design, program, and test the functionality and safety of any application made of this information and any resulting product. "High-Risk Device" means any device or system whose failure could cause personal injury, death, or property damage. Examples of High-Risk Devices are weapons, nuclear installations, surgical implants, and other medical devices. "Critical Component" means any component of a High-Risk Device whose failure to perform can be reasonably expected to cause, directly or indirectly, the failure of the High-Risk Device, or to affect its safety or effectiveness. Cypress is not liable, in whole or in part, and you shall and hereby do release Cypress from any claim, damage, or other liability arising from any use of a Cypress product as a Critical Component in a High-Risk Device. You shall indemnify and hold Cypress, its directors, officers, employees, agents, affiliates, distributors, and assigns harmless from and against all claims, costs, damages, and expenses, arising out of any claim, including claims for product liability, personal injury or death, or property damage arising from any use of a Cypress product as a Critical Component in a High-Risk Device. Cypress products are not intended or authorized for use as a Critical Component in any High-Risk Device except to the limited extent that (i) Cypress's published data sheet for the product explicitly states Cypress has qualified the product for use in a specific High-Risk Device, or (ii) Cypress has given you advance written authorization to use the product as a Critical Component in the specific High-Risk Device and you have signed a separate indemnification agreement.

Cypress, the Cypress logo, Spansion, the Spansion logo, and combinations thereof, WICED, PSoC, CapSense, EZ-USB, F-RAM, and Traveo are trademarks or registered trademarks of Cypress in the United States and other countries. For a more complete list of Cypress trademarks, visit [cypress.com](http://cypress.com). Other names and brands may be claimed as property of their respective owners.