

N-channel 600 V, 85 mΩ typ., 30 A, MDmesh M6 Power MOSFET in a TO-LL package

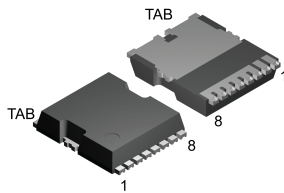

TO-LL type A

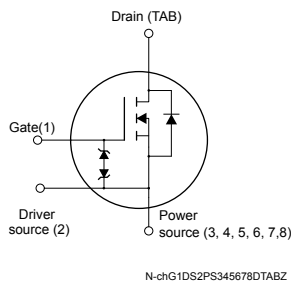

Features

Order code	V_{DS}	$R_{DS(on)}$ max.	I_D
STO36N60M6	600 V	99 mΩ	30 A

- Reduced switching losses
- Lower $R_{DS(on)}$ per area vs previous generation
- Low gate input resistance
- 100% avalanche tested
- Zener-protected
- Excellent switching performance thanks to the extra driving source pin

Applications

- Switching applications

Description

The new MDmesh M6 technology incorporates the most recent advancements to the well-known and consolidated MDmesh family of SJ MOSFETs. STMicroelectronics builds on the previous generation of MDmesh devices through its new M6 technology, which combines excellent $R_{DS(on)}$ per area improvement with one of the most effective switching behaviors available, as well as a user-friendly experience for maximum end-application efficiency.



Product status link

[STO36N60M6](#)

Product summary

Order code	STO36N60M6
Marking	36N60M6
Package	TO-LL type A
Packing	Tape and reel

1 Electrical ratings

Table 1. Absolute maximum ratings

Symbol	Parameter	Value	Unit
V_{GS}	Gate-source voltage	±25	V
I_D	Drain current (continuous) at $T_C = 25\text{ °C}$	30	A
	Drain current (continuous) at $T_C = 100\text{ °C}$	19	
$I_{DM}^{(1)}$	Drain current (pulsed)	102	A
P_{TOT}	Total power dissipation at $T_C = 25\text{ °C}$	230	W
$dv/dt^{(2)}$	Peak diode recovery voltage slope	15	V/ns
$dv/dt^{(3)}$	MOSFET dv/dt ruggedness	100	V/ns
T_{stg}	Storage temperature range	-55 to 150	°C
T_J	Operating junction temperature range		°C

1. Pulse width limited by safe operating area.
2. $I_{SD} \leq 30\text{ A}$, $di/dt \leq 400\text{ A}/\mu\text{s}$, $V_{DS}(\text{peak}) < V_{(BR)DSS}$, $V_{DD} = 400\text{ V}$.
3. $V_{DS} \leq 480\text{ V}$.

Table 2. Thermal data

Symbol	Parameter	Value	Unit
R_{thJC}	Thermal resistance, junction-to-case	0.54	°C/W
R_{thJB}	Thermal resistance, junction-to-board ⁽¹⁾	43	°C/W
	Thermal resistance, junction-to-board ⁽²⁾	22	

1. When mounted on 1 inch² FR-4 pcb, standard footprint 2 Oz copper board.
2. When mounted on 40x40mm FR-4 pcb, 6 cm² 2 Oz copper board.

Table 3. Avalanche characteristics

Symbol	Parameter	Value	Unit
I_{AR}	Avalanche current, repetitive or not repetitive (pulse width limited by T_J max.)	5	A
E_{AS}	Single pulse avalanche energy (starting $T_J = 25\text{ °C}$, $I_D = I_{AR}$, $V_{DD} = 50\text{ V}$)	750	mJ

2 Electrical characteristics

$T_C = 25\text{ °C}$ unless otherwise specified.

Table 4. On/off states

Symbol	Parameter	Test conditions	Min.	Typ.	Max.	Unit
$V_{(BR)DSS}$	Drain-source breakdown voltage	$V_{GS} = 0\text{ V}$, $I_D = 1\text{ mA}$	600			V
I_{DSS}	Zero gate voltage drain current	$V_{GS} = 0\text{ V}$, $V_{DS} = 600\text{ V}$			1	μA
		$V_{GS} = 0\text{ V}$, $V_{DS} = 600\text{ V}$, $T_C = 125\text{ °C}^{(1)}$			100	μA
I_{GSS}	Gate-body leakage current	$V_{DS} = 0\text{ V}$, $V_{GS} = \pm 25\text{ V}$			± 5	μA
$V_{GS(th)}$	Gate threshold voltage	$V_{DS} = V_{GS}$, $I_D = 250\text{ }\mu\text{A}$	3.25	4.00	4.75	V
$R_{DS(on)}$	Static drain-source on-resistance	$V_{GS} = 10\text{ V}$, $I_D = 15\text{ A}$		85	99	m Ω

1. Defined by design, not subject to production test.

Table 5. Dynamic

Symbol	Parameter	Test conditions	Min.	Typ.	Max.	Unit
C_{iss}	Input capacitance	$V_{DS} = 100\text{ V}$, $f = 1\text{ MHz}$, $V_{GS} = 0\text{ V}$	-	1960	-	pF
C_{oss}	Output capacitance		-	93	-	pF
C_{rSS}	Reverse transfer capacitance		-	6	-	pF
$C_{oss\text{ eq.}}^{(1)}$	Equivalent output capacitance	$V_{DS} = 0\text{ to }480\text{ V}$, $V_{GS} = 0\text{ V}$	-	332	-	pF
R_G	Intrinsic gate resistance	$f = 1\text{ MHz}$, $I_D = 0\text{ A}$	-	1.6	-	Ω
Q_g	Total gate charge	$V_{DD} = 480\text{ V}$, $I_D = 30\text{ A}$, $V_{GS} = 0\text{ to }10\text{ V}$ (see Figure 14. Test circuit for gate charge behavior)	-	44.3	-	nC
Q_{gs}	Gate-source charge		-	10.1	-	nC
Q_{gd}	Gate-drain charge		-	25	-	nC

1. $C_{oss\text{ eq.}}$ is defined as a constant equivalent capacitance giving the same charging time as C_{oss} when V_{DS} increases from 0 to 80% V_{DSS} .

Table 6. Switching times

Symbol	Parameter	Test conditions	Min.	Typ.	Max.	Unit
$t_{d(on)}$	Turn-on delay time	$V_{DD} = 300\text{ V}$, $I_D = 15\text{ A}$, $R_G = 4.7\text{ }\Omega$, $V_{GS} = 10\text{ V}$	-	15.2	-	ns
t_r	Rise time		-	5.3	-	ns
$t_{d(off)}$	Turn-off delay time	(see Figure 13. Switching times test circuit for resistive load and Figure 18. Switching time waveform)	-	50.2	-	ns
t_f	Fall time		-	7.3	-	ns

Table 7. Source-drain diode

Symbol	Parameter	Test conditions	Min.	Typ.	Max.	Unit
I_{SD}	Source-drain current		-		30	A
$I_{SDM}^{(1)}$	Source-drain current (pulsed)		-		102	A
$V_{SD}^{(2)}$	Forward on voltage	$V_{GS} = 0\text{ V}, I_{SD} = 30\text{ A}$	-		1.6	V
t_{rr}	Reverse recovery time	$I_{SD} = 30\text{ A}, di/dt = 100\text{ A}/\mu\text{s},$	-	340		ns
Q_{rr}	Reverse recovery charge	$V_{DD} = 60\text{ V}$	-	5.3		μC
I_{RRM}	Reverse recovery current	(see Figure 15. Test circuit for inductive load switching and diode recovery times)	-	31		A
t_{rr}	Reverse recovery time	$I_{SD} = 30\text{ A}, di/dt = 100\text{ A}/\mu\text{s},$	-	430		ns
Q_{rr}	Reverse recovery charge	$V_{DD} = 60\text{ V}, T_J = 150\text{ }^\circ\text{C}$	-	7.7		μC
I_{RRM}	Reverse recovery current	(see Figure 15. Test circuit for inductive load switching and diode recovery times)	-	36		A

1. Pulse width is limited by safe operating area.
2. Pulse test: pulse duration = 300 μs , duty cycle 1.5%.

2.1 Electrical characteristics (curves)

Figure 1. Safe operating area

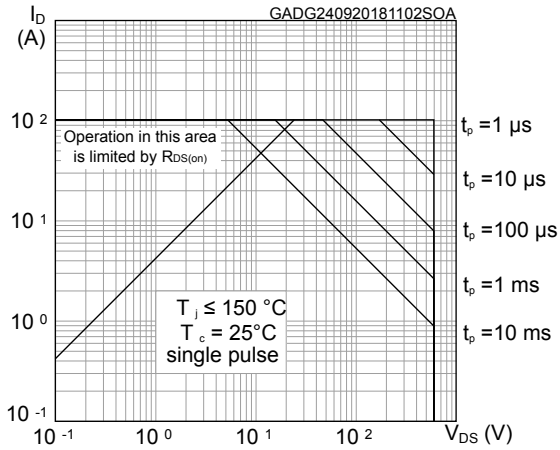

Figure 2. Thermal impedance

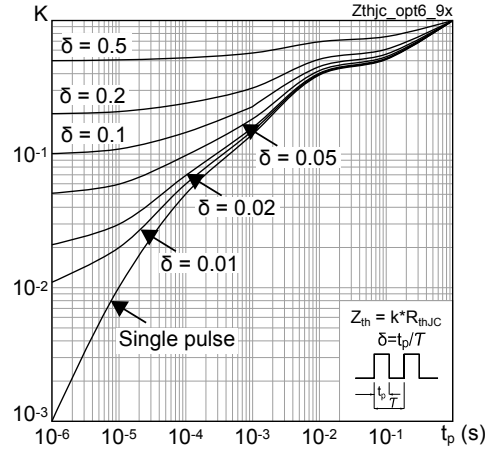

Figure 3. Output characteristics

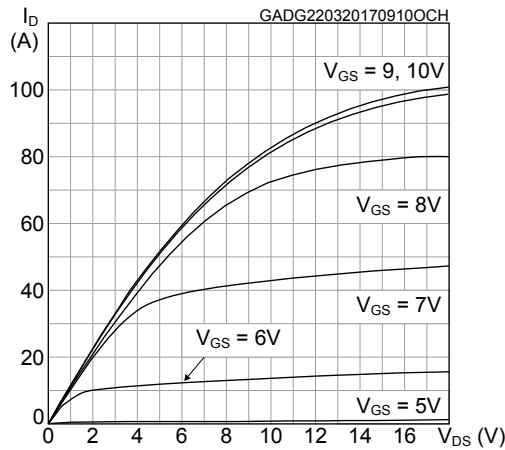

Figure 4. Transfer characteristics

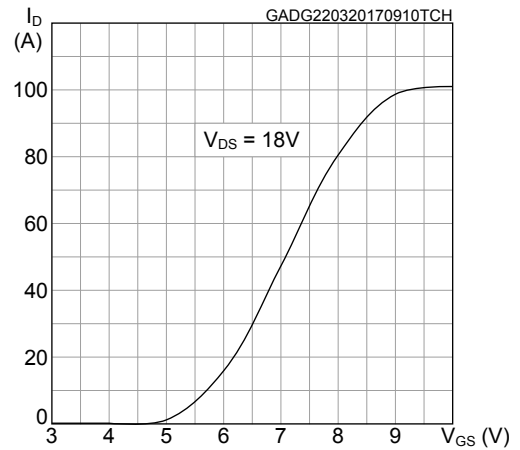

Figure 5. Gate charge vs gate-source voltage

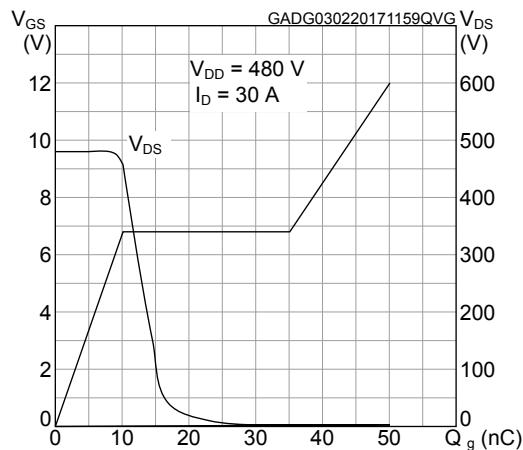

Figure 6. Static drain-source on-resistance

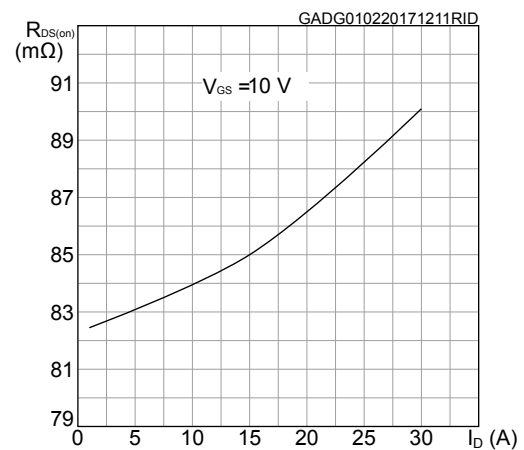

Figure 7. Capacitance variations

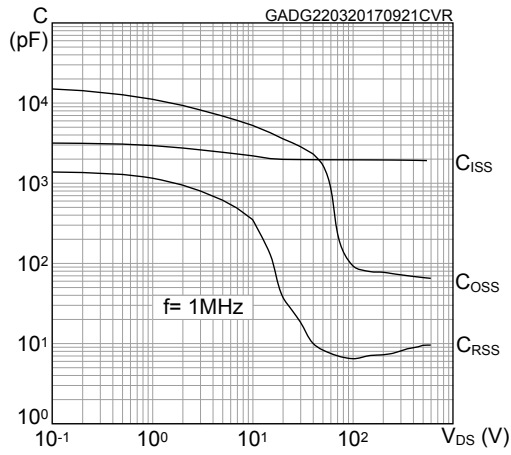

Figure 8. Normalized gate threshold voltage vs temperature

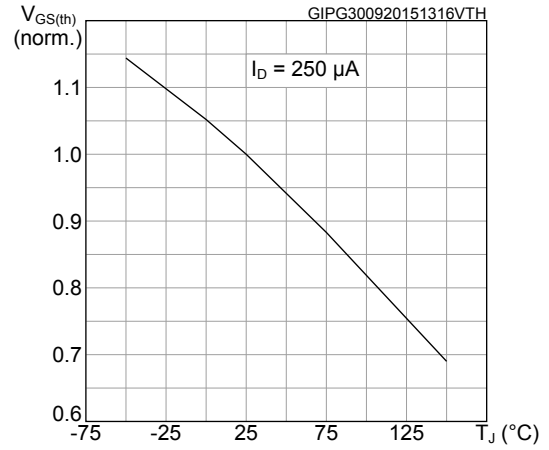

Figure 9. Normalized on-resistance vs temperature

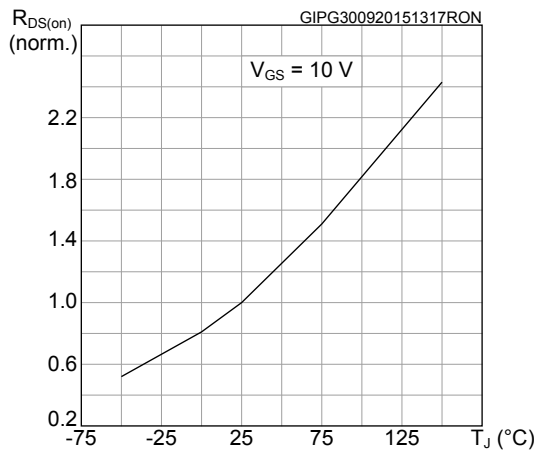

Figure 10. Normalized V_(BR)DSS vs temperature

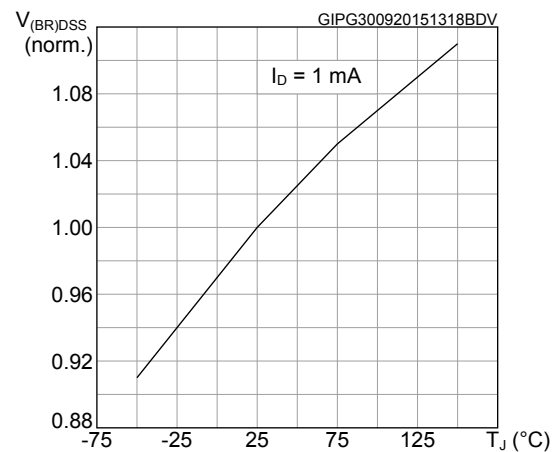

Figure 11. Output capacitance stored energy

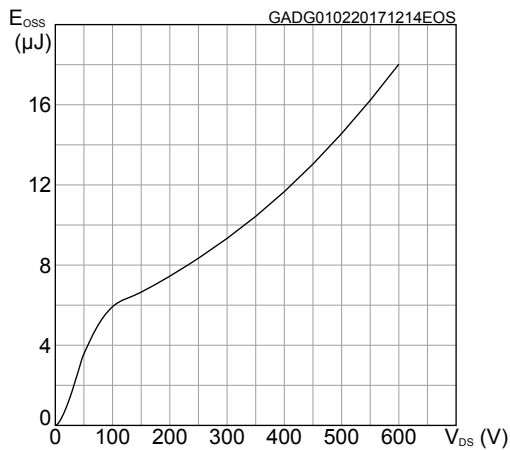
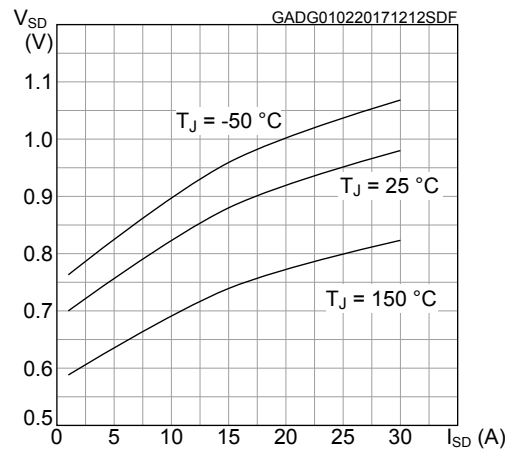
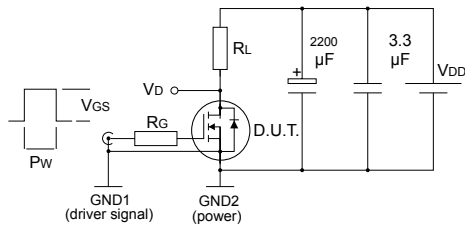

Figure 12. Source-drain diode forward characteristics



3 Test circuits

Figure 13. Switching times test circuit for resistive load

AM15855v1

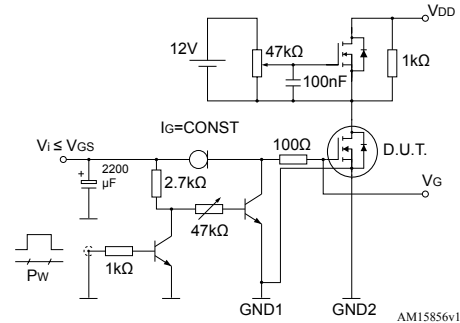
Figure 14. Test circuit for gate charge behavior

AM15856v1

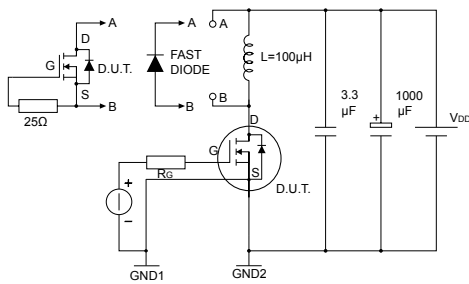
Figure 15. Test circuit for inductive load switching and diode recovery times

AM15857v1

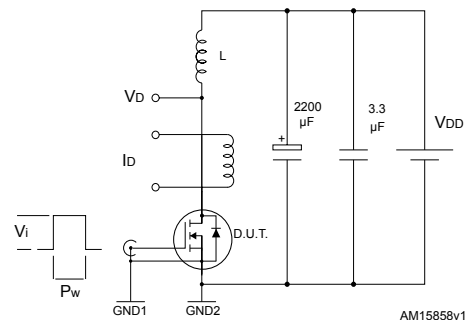
Figure 16. Unclamped inductive load test circuit

AM15858v1

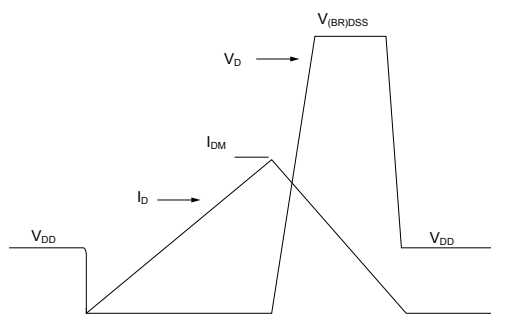
Figure 17. Unclamped inductive waveform

AM01472v1

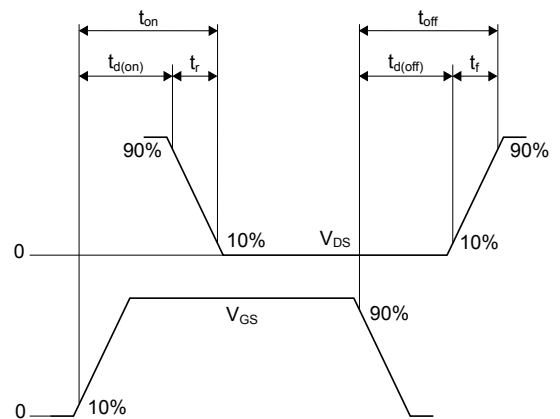
Figure 18. Switching time waveform

AM01473v1

4 Package information

In order to meet environmental requirements, ST offers these devices in different grades of **ECOPACK** packages, depending on their level of environmental compliance. ECOPACK specifications, grade definitions and product status are available at: www.st.com. ECOPACK is an ST trademark.

4.1 TO-LL type A package information

Figure 19. TO-LL type A package outline

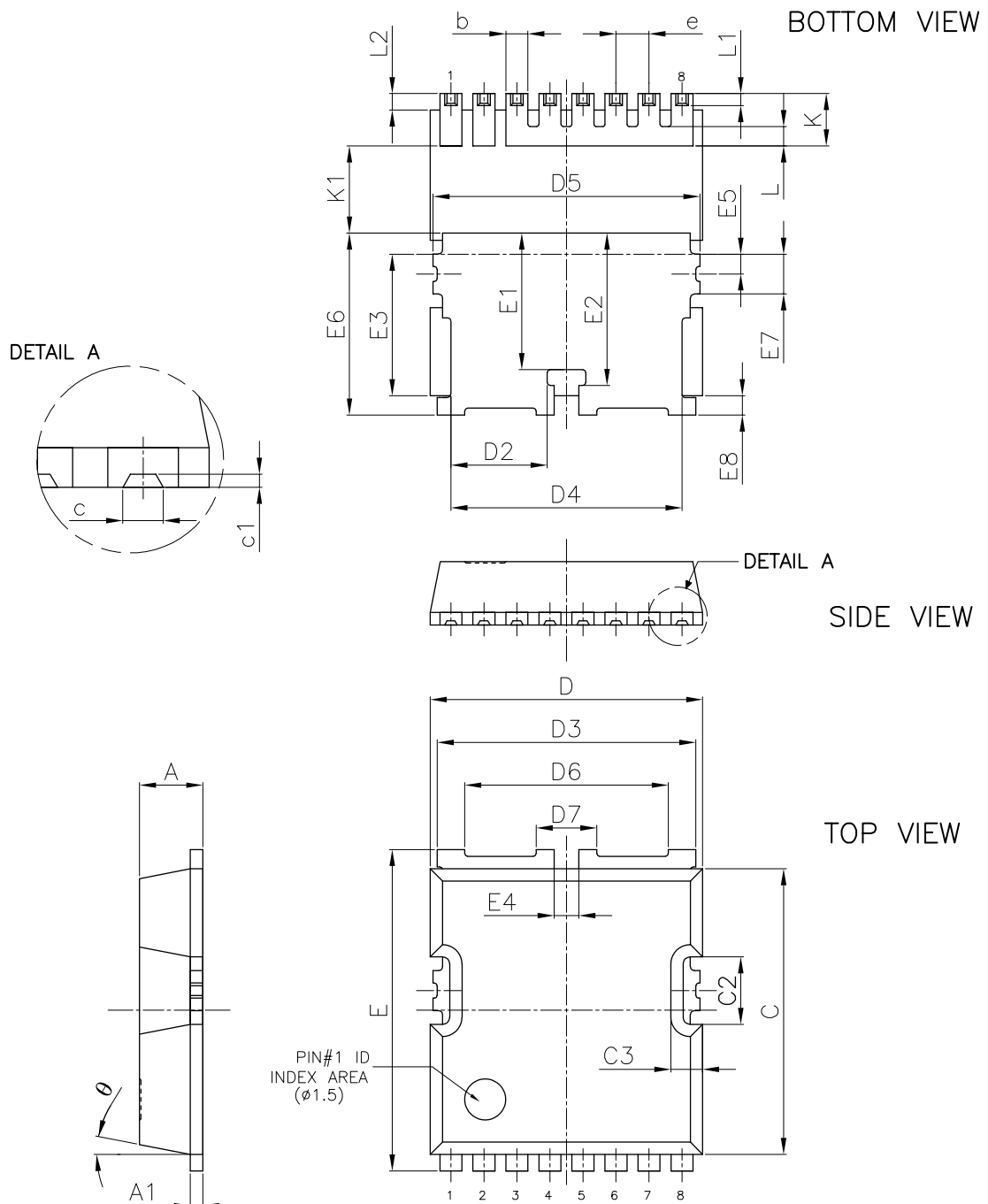

DM00276569_5_type_A

Table 8. TO-LL type A package mechanical data

Dim.	mm		
	Min.	Typ.	Max.
A	2.20	2.30	2.40
A1	0.40	0.48	0.60
b	0.70	0.80	0.90
c		0.46	
c1		0.15	
C	10.28	10.38	10.48
C2	2.35	2.45	2.55
C3		1.16	
D	9.80	9.90	10.00
D2	3.30	3.50	3.70
D3	9.30	9.40	9.50
D4	8.20	8.40	8.60
D5	9.50	9.70	9.90
D6		7.40	
D7		2.20	
e		1.20	
E	11.48	11.68	11.88
E1		4.96	
E2		5.54	
E3		5.14	
E4		0.90	
E5		0.72	
E6	6.41	6.61	6.81
E7		1.44	
E8	0.50	0.70	0.90
K	1.70	1.90	2.10
K1	2.70		
L		0.70	
L1		0.44	
L2	0.40	0.60	0.80
θ		11°	

Figure 20. TO-LL type A recommended footprint (dimensions are in mm)

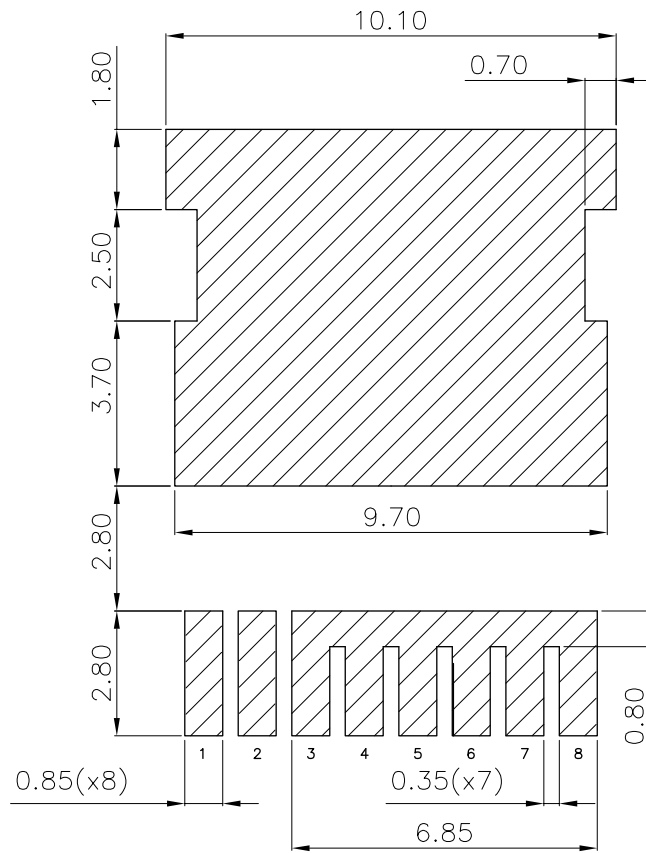

DM00276569_5_type_A_FP

4.2 TO-LL packing information

Figure 21. Carrier tape outline and dimensions

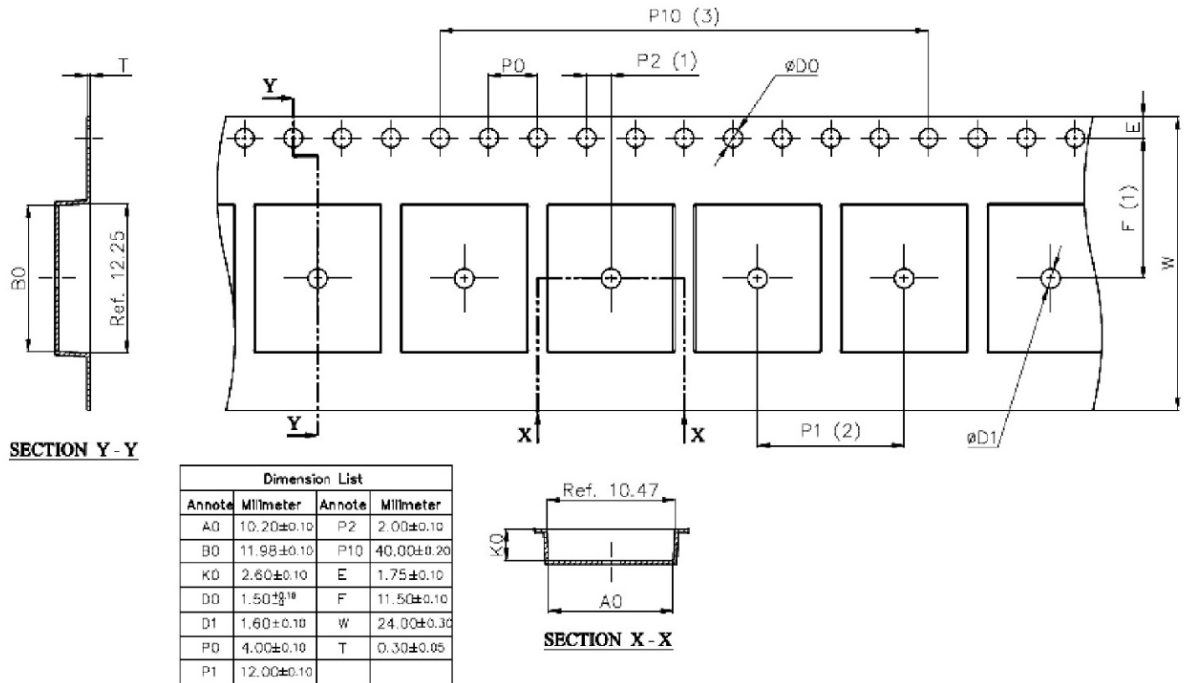

Figure 22. Reel outline and dimensions

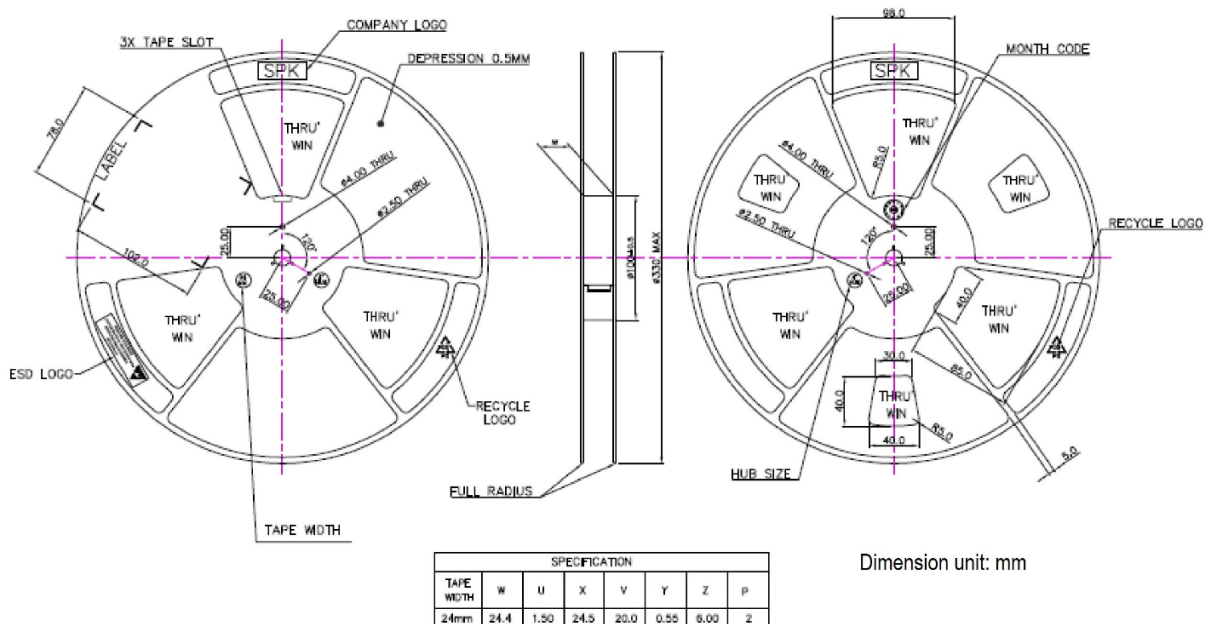
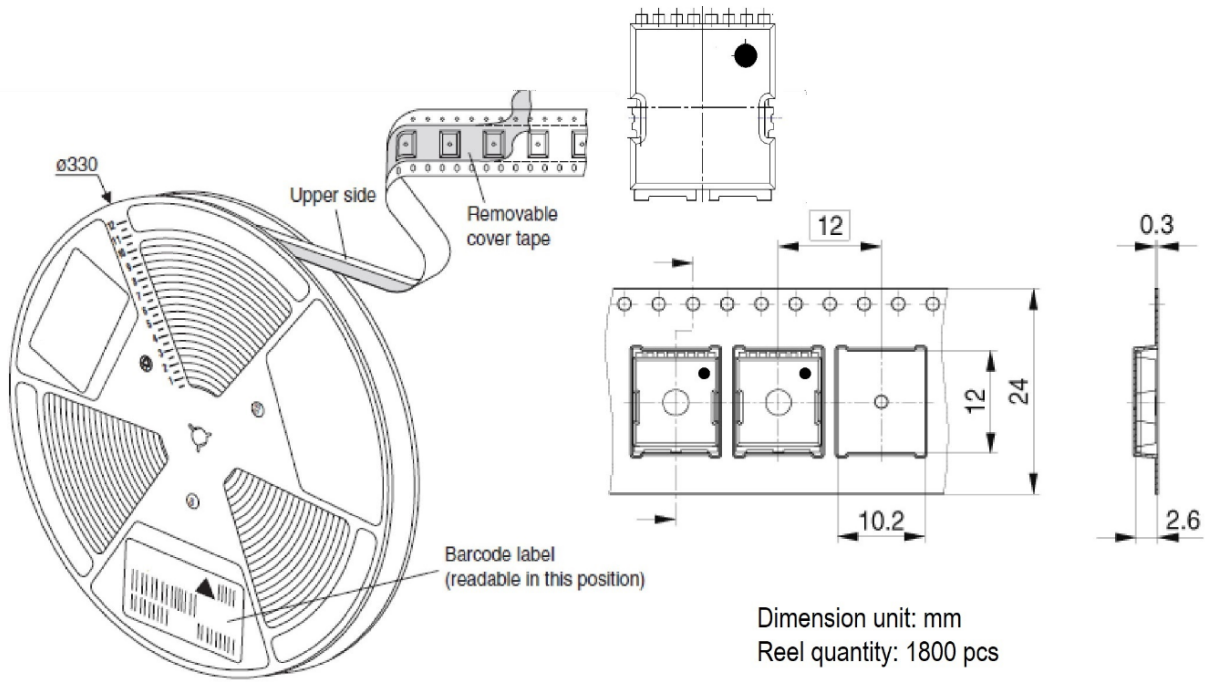

Figure 23. TO-LL orientation in tape pocket



Revision history

Table 9. Document revision history

Date	Version	Changes
21-Apr-2017	1	First release.
08-Oct-2018	2	Updated <i>Section 1 Electrical ratings</i> , <i>Section 2 Electrical characteristics</i> and <i>Section 3 Test circuits</i> . Updated <i>Section 4.1 TO-LL type A package information</i> . Minor text changes
05-May-2021	3	Updated title and <i>Device summary</i> in cover page. Updated <i>Table 2. Thermal data</i> . Updated <i>Section 4 Package information</i> . Minor text changes.
10-May-2021	4	Updated <i>Section 3 Test circuits</i> .

Contents

1	Electrical ratings	2
2	Electrical characteristics	3
2.1	Electrical characteristics (curves)	5
3	Test circuits	7
4	Package information	8
4.1	TO-LL type A package information	8
4.2	TO-LL packing information	11
	Revision history	13

IMPORTANT NOTICE – PLEASE READ CAREFULLY

STMicroelectronics NV and its subsidiaries (“ST”) reserve the right to make changes, corrections, enhancements, modifications, and improvements to ST products and/or to this document at any time without notice. Purchasers should obtain the latest relevant information on ST products before placing orders. ST products are sold pursuant to ST’s terms and conditions of sale in place at the time of order acknowledgement.

Purchasers are solely responsible for the choice, selection, and use of ST products and ST assumes no liability for application assistance or the design of Purchasers’ products.

No license, express or implied, to any intellectual property right is granted by ST herein.

Resale of ST products with provisions different from the information set forth herein shall void any warranty granted by ST for such product.

ST and the ST logo are trademarks of ST. For additional information about ST trademarks, please refer to www.st.com/trademarks. All other product or service names are the property of their respective owners.

Information in this document supersedes and replaces information previously supplied in any prior versions of this document.

© 2021 STMicroelectronics – All rights reserved