

Low Noise Amplifier with Bypass for LTE

■ GENERAL DESCRIPTION

NJG1173UX2 is low noise amplifier with bypass switch for LTE, which covers frequency from 3300MHz to 3800MHz.

NJG1173UX2 is able to select LNA active mode or bypass mode by low control voltage. This LNA achieves low noise figure and high linearity.

Integrated ESD protection device on each port achieves excellent ESD robustness.

A very small and ultra-thin package EPFFP6-X2 is adopted.

■ PACKAGE OUTLINE

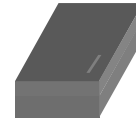

NJG1173UX2

■ APPLICATIONS

LTE receive application

WiMAX 3.5GHz receive application

RF front-end modules, smartphones, data cards and others mobile application

■ FEATURES

- Operating frequencies 3300MHz to 3800MHz
- Low control voltage 1.3V to 5.5V
- Low current consumption 5.0/3.5mA typ. @ $V_{DD}=2.8/1.8V$
- High Gain 13.5dB typ. @ $V_{DD}=2.8V$ $f_{RF}=3500MHz$
- Low Noise figure 1.0dB typ. @ $V_{DD}=2.8V$ $f_{RF}=3500MHz$
- High IIP3 +5.0dBm typ. @ $V_{DD}=2.8V$, $f_{RF}=3500MHz+3510MHz$
- Insertion loss in bypass mode 3.5dB typ. @ $V_{DD}=2.8V$, $f_{RF}=3500MHz$
- Ultra-small package size EPFFP6-X2 (1.1mm x 0.7mm x 0.37mm typ.)
- RoHS compliant and Halogen Free, MSL1

■ PIN CONFIGURATION

(Top view)

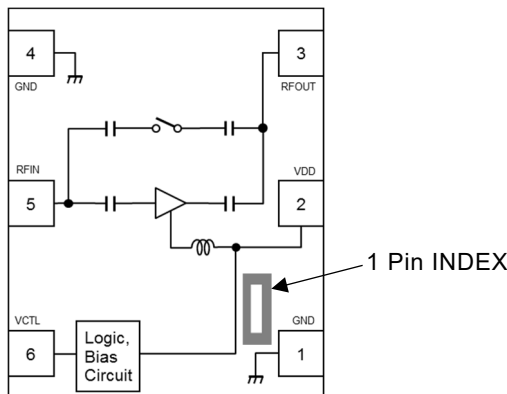

Pin Connection

1. GND
2. VDD
3. RFOUT
4. GND
5. RFIN
6. VCTL

■ TRUTH TABLE

“H”= $V_{CTL}(H)$, “L”= $V_{CTL}(L)$

V_{CTL}	Mode
L	Bypass mode
H	LNA active mode

Note: Specifications and description listed in this datasheet are subject to change without notice

■ ABSOLUTE MAXIMUM RATINGS

General condition: $T_a=+25^{\circ}\text{C}$, $Z_s=Z_l=50\Omega$

PARAMETER	SYMBOL	CONDITIONS	RATINGS	UNITS
Operating voltage	V_{DD}		6.0	V
Control voltage	V_{CTL}		6.0	V
Input power	P_{IN}	$V_{DD}=2.8\text{V}$	+15	dBm
Power dissipation	P_D	4-layer FR4 PCB with through-hole (101.5x114.5mm), $T_j=150^{\circ}\text{C}$	430	mW
Operating temperature	T_{opr}		-40 to +105	$^{\circ}\text{C}$
Storage temperature	T_{stg}		-55 to +150	$^{\circ}\text{C}$

■ ELECTRICAL CHARACTERISTICS 1 (DC)

General condition: $T_a=+25^{\circ}\text{C}$

PARAMETERS	SYMBOL	CONDITIONS	MIN	TYP	MAX	UNITS
Operating voltage	V_{DD}		1.5	-	5.5	V
Control voltage (High)	$V_{CTL(H)}$		1.3	1.8	5.5	V
Control voltage (Low)	$V_{CTL(L)}$		0	0	0.3	V
Operating current 1	I_{DD1}	RF OFF, $V_{DD}=2.8\text{V}$, $V_{CTL}=1.8\text{V}$	-	5.0	8.0	mA
Operating current 2	I_{DD2}	RF OFF, $V_{DD}=1.8\text{V}$, $V_{CTL}=1.8\text{V}$	-	3.5	7.0	mA
Operating current 3	I_{DD3}	RF OFF, $V_{DD}=2.8\text{V}$, $V_{CTL}=0\text{V}$	-	15	60	μA
Operating current 4	I_{DD4}	RF OFF, $V_{DD}=1.8\text{V}$, $V_{CTL}=0\text{V}$	-	10	60	μA
Control current	I_{CTL}	RF OFF, $V_{CTL}=1.8\text{V}$	-	7	20	μA

■ ELECTRICAL CHARACTERISTICS 2 (LNA active mode)

General Condition: $V_{DD}=2.8V$, $V_{CTL}=1.8V$, $f_{RF}=3500MHz$, $T_a=+25^{\circ}C$, $Z_s=Z_l=50\Omega$, with application circuit

PARAMETERS	SYMBOL	CONDITIONS	MIN	TYP	MAX	UNITS
Small signal gain1	Gain1	Exclude PCB & connector losses(0.32dB)	11.0	13.5	16.0	dB
Noise figure1	NF1	Exclude PCB & connector losses(0.14dB)	-	1.0	1.6	dB
Input power at 1dB gain compression point1(1)	P-1dB(IN)1(1)		-13.0	-10.0	-	dBm
Input 3rd order intercept point1(1)	IIP3_1(1)	$f1=f_{RF}$, $f2=f_{RF}+10MHz$, $P_{IN}=-28dBm$	-2.0	+5.0	-	dBm
Gain settling time1(1)	Ts1(1)	Bypass to LNA active mode To be within 1 dB of the final gain	-	1.0	2.5	μs
Gain settling time1(2)	Ts1(2)	LNA active to Bypass mode To be within 1 dB of the final insertion loss	-	0.8	2.5	μs
RF IN Return loss1(1)	RLi1(1)		5.0	9.0	-	dB
RF OUT Return loss1(1)	RLo1(1)		10.0	15.0	-	dB

■ ELECTRICAL CHARACTERISTICS 3 (Bypass mode)

General Condition: $V_{DD}=2.8V$, $V_{CTL}=0V$, $f_{RF}=3500MHz$, $T_a=+25^{\circ}C$, $Z_s=Z_l=50\Omega$, with application circuit

PARAMETERS	SYMBOL	CONDITIONS	MIN	TYP	MAX	UNITS
Insertion Loss1	Loss1	Exclude PCB & connector losses(0.32dB)	-	3.5	5.0	dB
Input power at 1dB Compression point1(2)	P-1dB(IN)1(2)		-1.0	+10.0	-	dBm
Input 3rd order intercept point1(2)	IIP3_1(2)	$f1=f_{RF}$, $f2=f_{RF}+10MHz$, $P_{IN}=-10dBm$	+9.0	+18.0	-	dBm
RF IN Return loss1(2)	RLi1(2)		5.0	7.0	-	dB
RF OUT Return loss1(2)	RLo1(2)		4.0	6.0	-	dB

■ ELECTRICAL CHARACTERISTICS 4 (LNA active mode)

General Condition: $V_{DD}=1.8V$, $V_{CTL}=1.8V$, $f_{RF}=3500MHz$, $T_a=+25^{\circ}C$, $Z_s=Z_l=50\Omega$, with application circuit

PARAMETERS	SYMBOL	CONDITIONS	MIN	TYP	MAX	UNITS
Small signal gain ₂	Gain ₂	Exclude PCB & connector losses(0.32dB)	-	12.0	-	dB
Noise figure ₂	NF ₂	Exclude PCB & connector losses(0.14dB)	-	1.3	-	dB
Input power at 1dB gain compression point ₂ (1)	P-1dB(IN) ₂ (1)		-	-12.0	-	dBm
Input 3rd order intercept point ₂ (1)	IIP3_2(1)	$f_1=f_{RF}$, $f_2=f_{RF}+10MHz$, $P_{IN}=-28dBm$	-	0	-	dBm
Gain settling Time ₂ (1)	Ts ₂ (1)	Bypass to LNA active mode To be within 1 dB of the final gain	-	2.0	-	μs
Gain settling Time ₂ (2)	Ts ₂ (2)	LNA active to Bypass mode To be within 1 dB of the final insertion loss	-	0.8	-	μs
RF IN Return loss ₂ (1)	RLi ₂ (1)		-	8.0	-	dB
RF OUT Return loss ₂ (1)	RLo ₂ (1)		-	15.0	-	dB

■ ELECTRICAL CHARACTERISTICS 5 (Bypass mode)

General Condition: $V_{DD}=1.8V$, $V_{CTL}=0V$, $f_{RF}=3500MHz$, $T_a=+25^{\circ}C$, $Z_s=Z_l=50\Omega$, with application circuit

PARAMETERS	SYMBOL	CONDITIONS	MIN	TYP	MAX	UNITS
Insertion Loss ₂	Loss ₂	Exclude PCB & connector losses(0.32dB)	-	3.5	-	dB
Input power at 1dB compression Point ₂ (2)	P-1dB(IN) ₂ (2)		-	+9.0	-	dBm
Input 3rd order intercept point ₂ (2)	IIP3_2(2)	$f_1=f_{RF}$, $f_2=f_{RF}+10MHz$, $P_{IN}=-10dBm$	-	+17.0	-	dBm
RF IN Return loss ₂ (2)	RLi ₂ (2)		-	7.0	-	dB
RF OUT Return loss ₂ (2)	RLo ₂ (2)		-	6.0	-	dB

■ TERMINAL INFORMATION

No.	SYMBOL	DESCRIPTION
1	GND	Ground terminal. This terminal should be connected to the ground plane as close as possible for excellent RF performance.
2	VDD	Supply voltage terminal. Please connect bypass capacitor C1 with ground as close as possible.
3	RFOUT	RF output terminal. This terminal requires no DC blocking capacitor since this IC has internal output matching circuit including DC blocking capacitor.
4	GND	Ground terminal. This terminal should be connected to the ground plane as close as possible for excellent RF performance.
5	RFIN	RF input terminal. This terminal requires only a matching inductor L1, and does not require DC blocking capacitor.
6	VCTL	Control voltage terminal.

■ ELECTRICAL CHARACTERISTICS (LNA active mode)

Conditions: $V_{DD}=2.8V$, $V_{CTL}=1.8V$, $f_{RF}=3500MHz$, $T_a=+25^{\circ}C$, $Z_s=Z_l=50\Omega$, with application circuit

Gain, NF vs. frequency

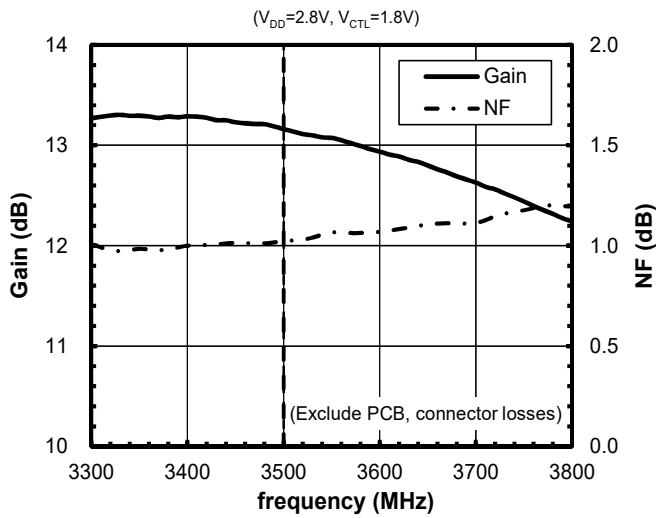

Gain, I_{DD} vs. Pin

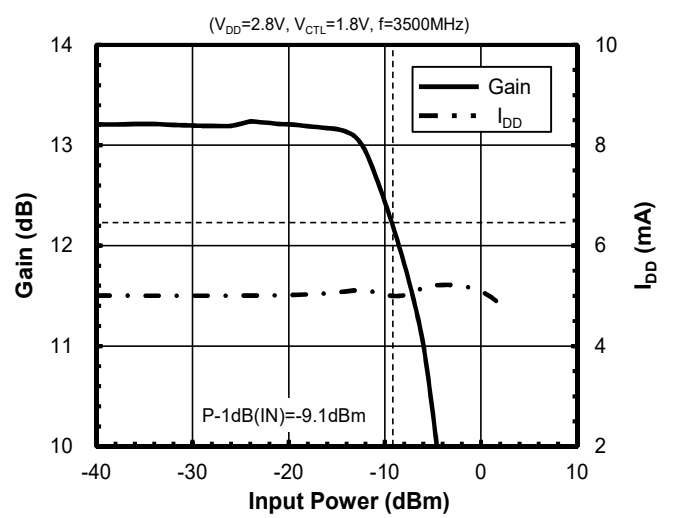

Pout vs. Pin

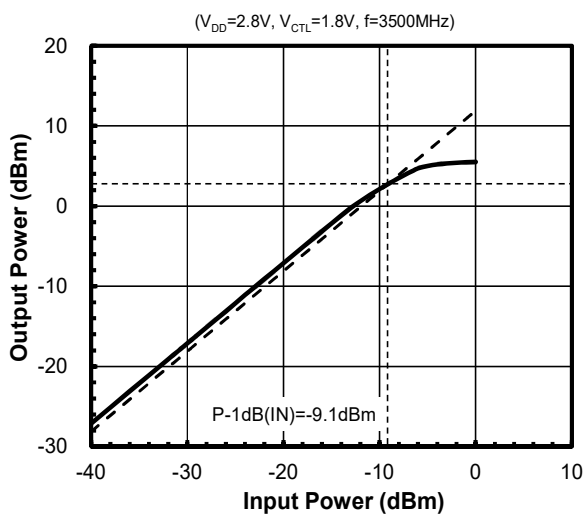

P-1dB(IN) vs. frequency

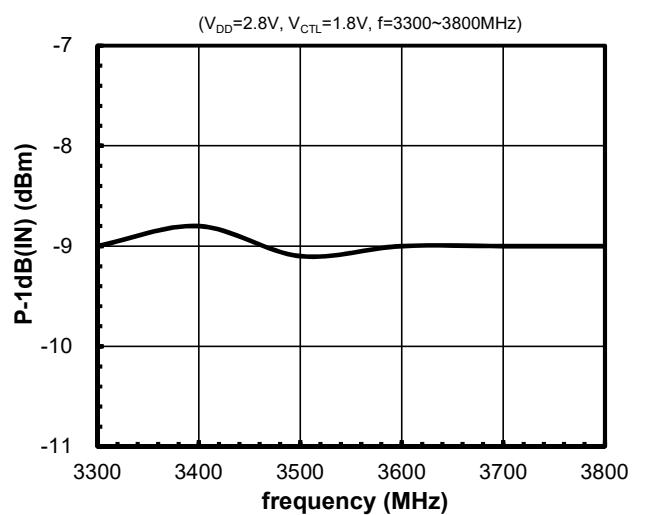

IIP3, OIP3 vs. frequency

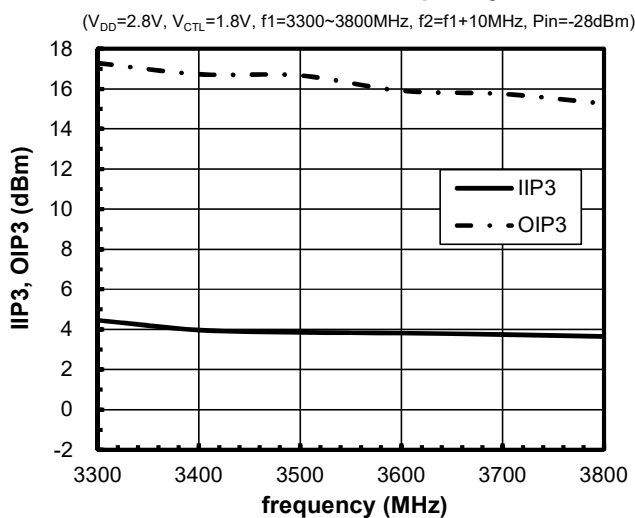

Pout, IM3 vs. Pin

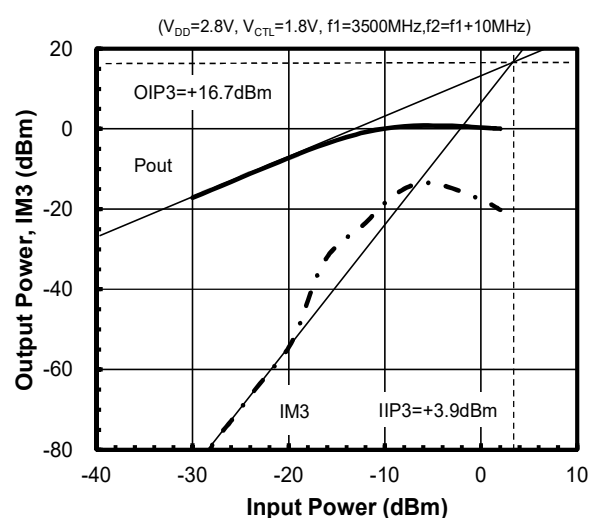

■ ELECTRICAL CHARACTERISTICS (LNA active mode)

Conditions: $V_{DD}=2.8V$, $V_{CTL}=1.8V$, $f_{RF}=50MHz$ to $6000MHz$, $T_a=+25^{\circ}C$, $Z_s=Z_l=50\Omega$, with application circuit

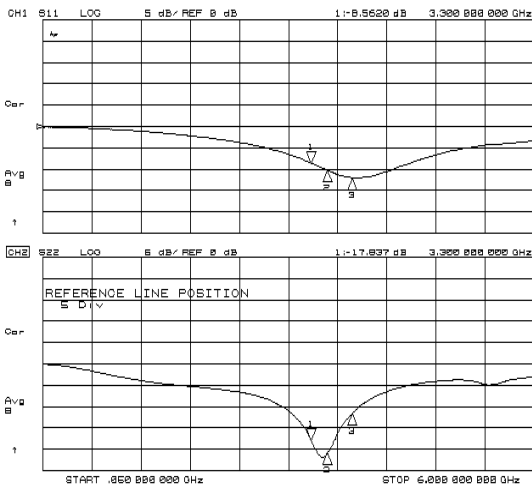

S11, S22

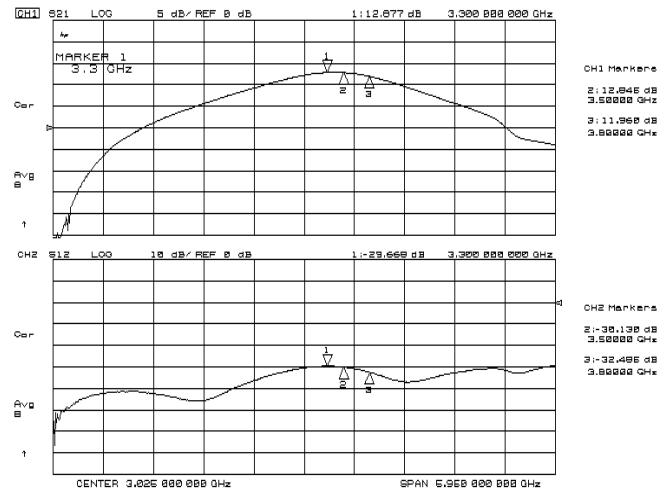

S21, S12

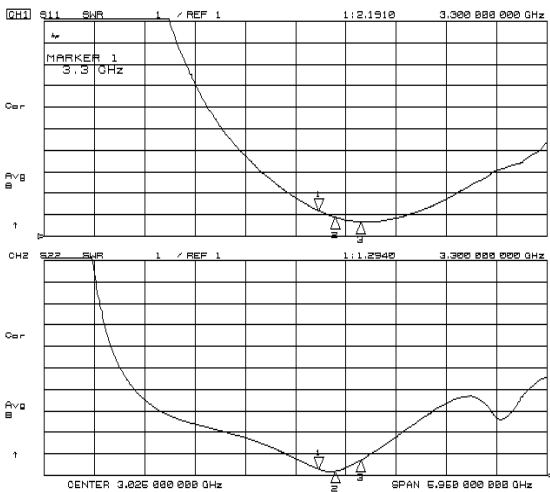

VSWRi, VSWRo

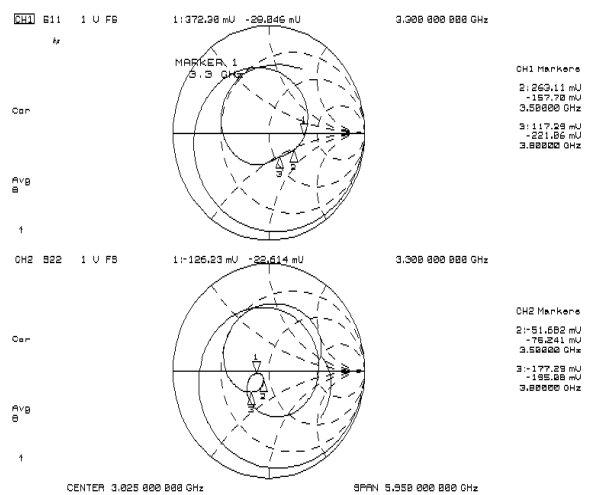

Zin, Zout

■ ELECTRICAL CHARACTERISTICS (Bypass mode)

Conditions: $V_{DD}=2.8V$, $V_{CTL}=0V$, $f_{RF}=3500MHz$, $T_a=+25^\circ C$, $Z_s=Z_l=50\Omega$, with application circuit

Loss vs. frequency

($V_{DD}=2.8V$, $V_{CTL}=0V$)

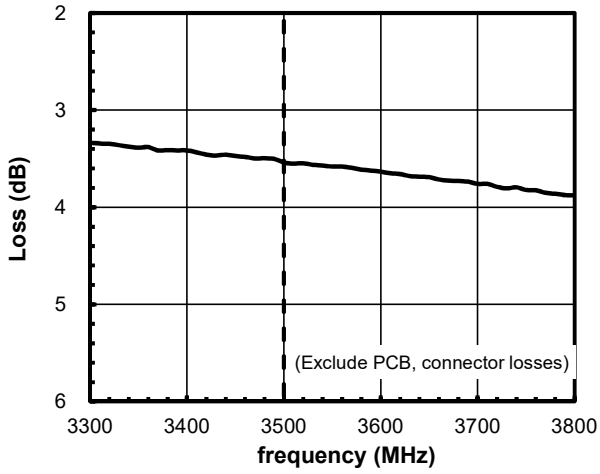

Loss, I_{DD} vs. Pin

($V_{DD}=2.8V$, $V_{CTL}=0V$, $f=3500MHz$)

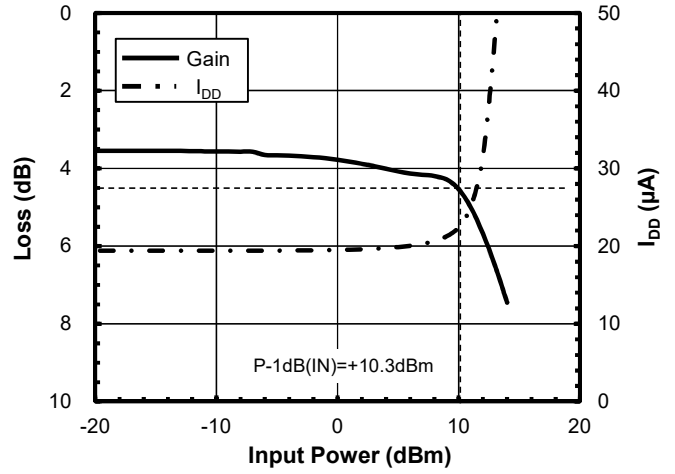

Pout vs. Pin

($V_{DD}=2.8V$, $V_{CTL}=0V$, $f=3500MHz$)

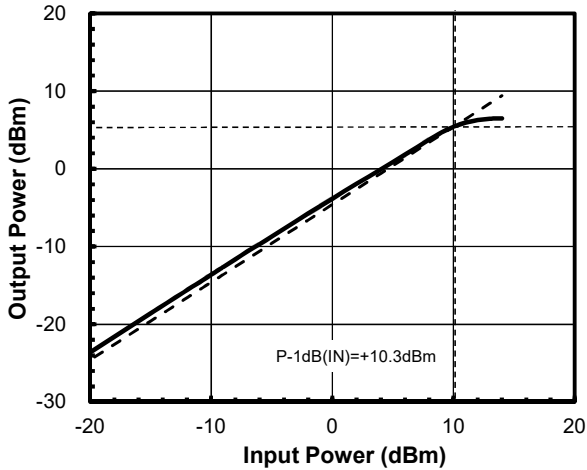

P-1dB(IN) vs. frequency

($V_{DD}=2.8V$, $V_{CTL}=0V$, $f=3300\sim 3800MHz$)

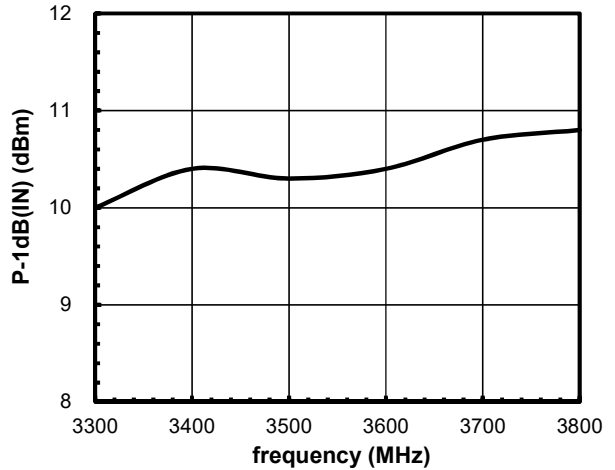

IIP3, OIP3 vs. frequency

($V_{DD}=2.8V$, $V_{CTL}=0V$, $f_1=3300\sim 3800MHz$, $f_2=f_1+10MHz$, $Pin=-10dBm$)

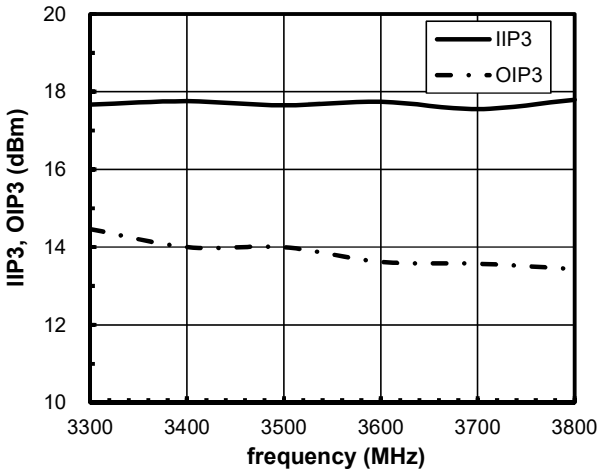

Pout, IM3 vs. Pin

($V_{DD}=2.8V$, $V_{CTL}=0V$, $f_1=3500MHz$, $f_2=f_1+10MHz$)

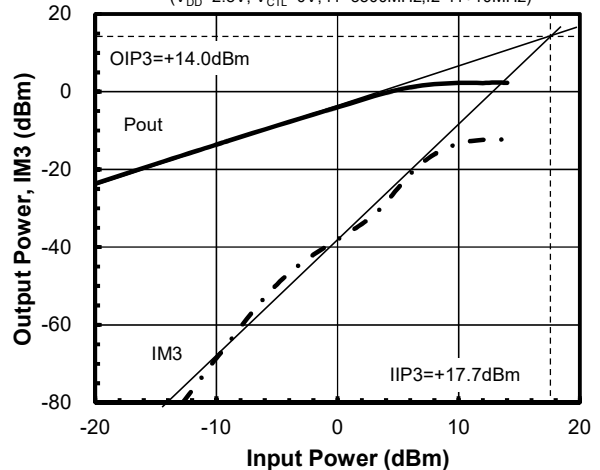

■ ELECTRICAL CHARACTERISTICS (Bypass mode)

Conditions: $V_{DD}=2.8V$, $V_{CTL}=0V$, $f_{RF}=50MHz$ to $6000MHz$, $T_a=+25^\circ C$, $Z_s=Z_l=50\Omega$, with application circuit

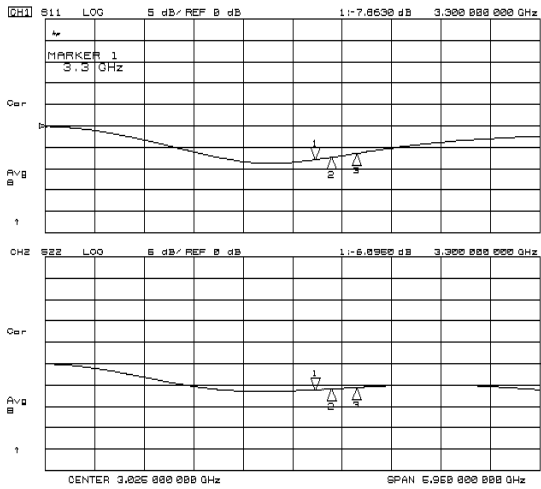

S11, S22

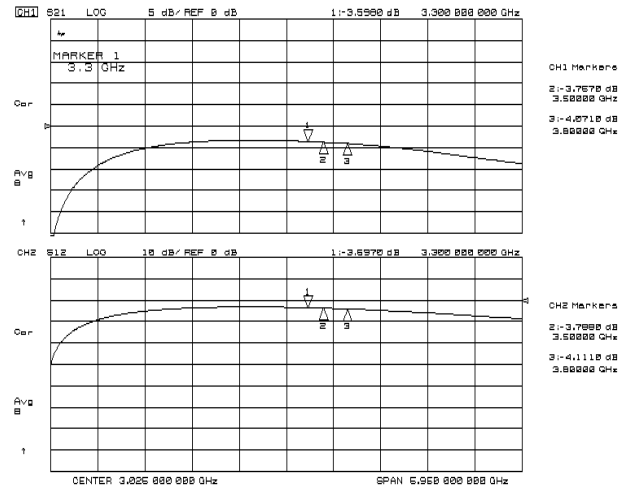

S21, S12

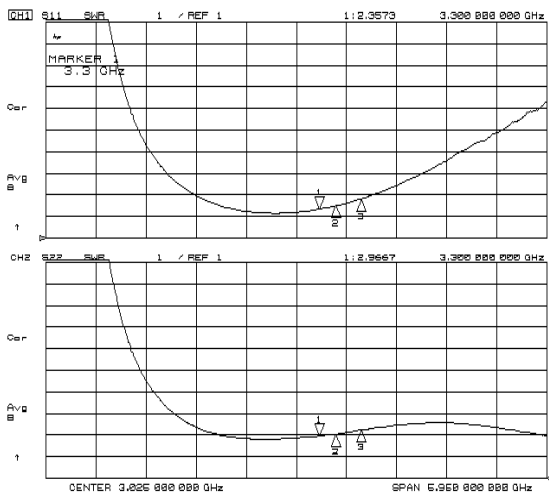

VSWRi, VSWRo

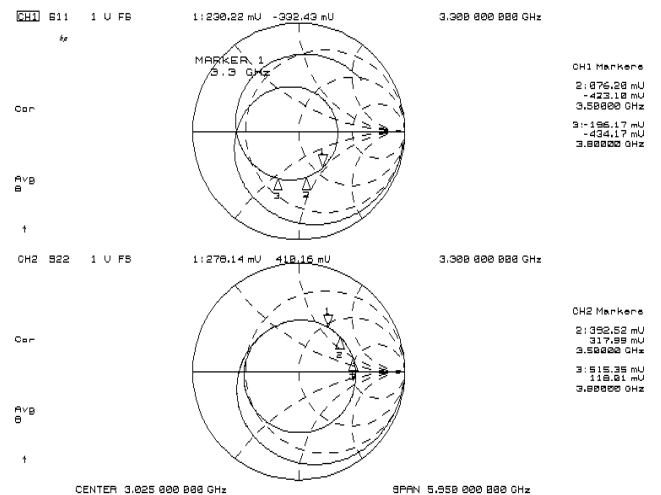

Zin, Zout

APPLICATION CIRCUIT

(TOP VIEW)

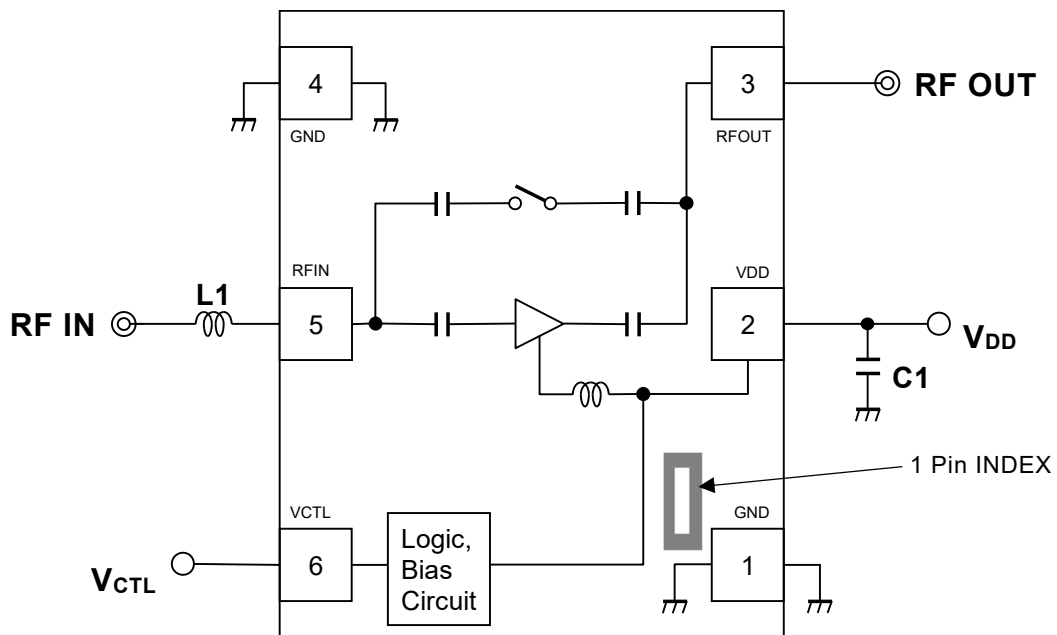

Parts list

Parts ID	Value	Manufacture
L1	2.9nH	LQW15AN_00 Series (MURATA)
C1	1000pF	GRM03 Series (MURATA)

■ MEASUREMENT BLOCK DIAGRAM

Measuring instruments

NF Analyzer : Keysight N8975A
 Noise Source : Keysight 346A

Setting the NF analyzer

Measurement mode form

Device under test : Amplifier
 System downconverter : off

Mode setup form

Sideband : LSB
 Averages : 16
 Average mode : Point
 Bandwidth : 4MHz
 Loss comp : off
 Tcold : setting the temperature of noise source (305.15K)

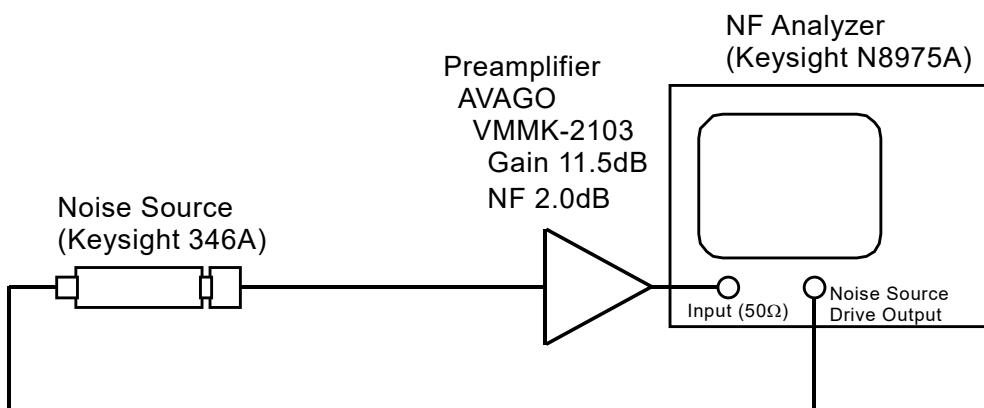

* Pre-amplifier is used to improve NF measurement accuracy.
 * Noise source, pre-amplifier and NF analyzer are connected directly.

Calibration setup

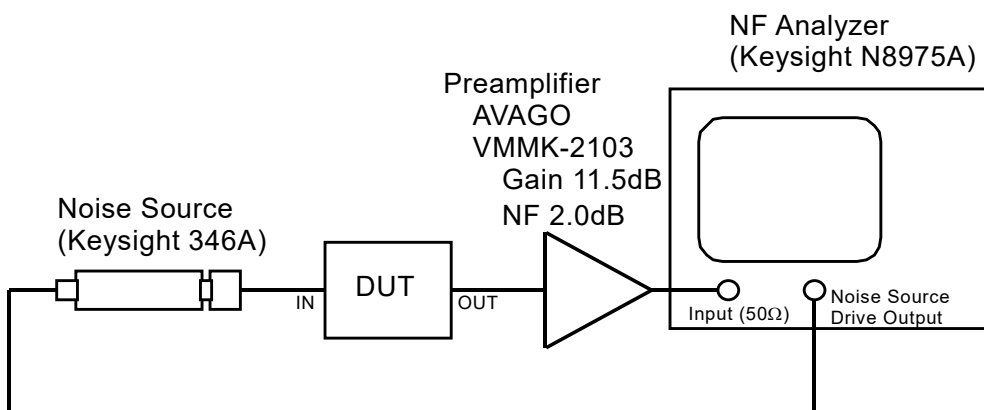

* Noise source, DUT, pre-amplifier and NF analyzer are connected directly.

Measurement Setup

■ EVALUATION BOARD

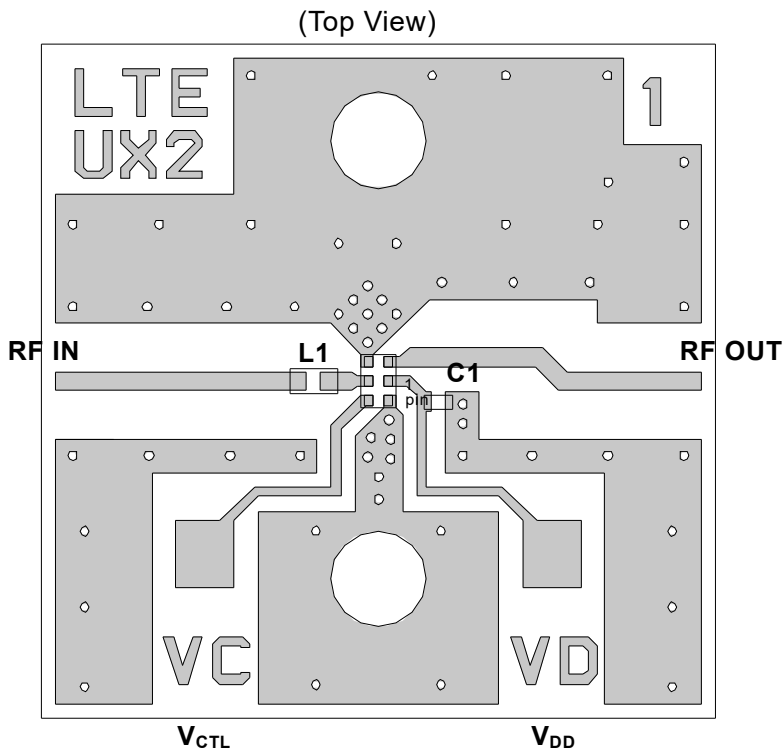

PCB Information

Substrate: FR-4

Thickness: 0.2mm

Microstrip line width: 0.4mm ($Z_0=50\Omega$)

Size: 14.0mm x 14.0mm

< PCB LAYOUT GUIDELINE >

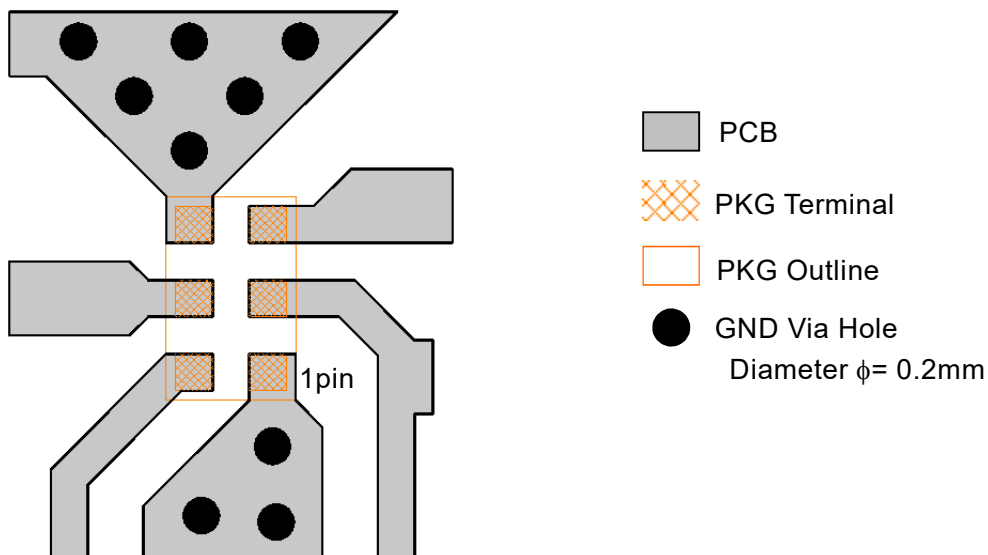



PRECAUTIONS

- All external parts should be placed as close as possible to the IC.
- For good RF performance, all GND terminals must be connected to PCB ground plane of substrate, and via-holes for GND should be placed near the IC.

RECOMMENDED FOOTPRINT PATTERN (EPFFP6-X2 PACKAGE)

Package: 1.1mm x 0.7mm

Pin pitch: 0.4mm

-  : Land
-  : Mask (Open area) *Metal mask thickness: 100μm
-  : Resist (Open area)

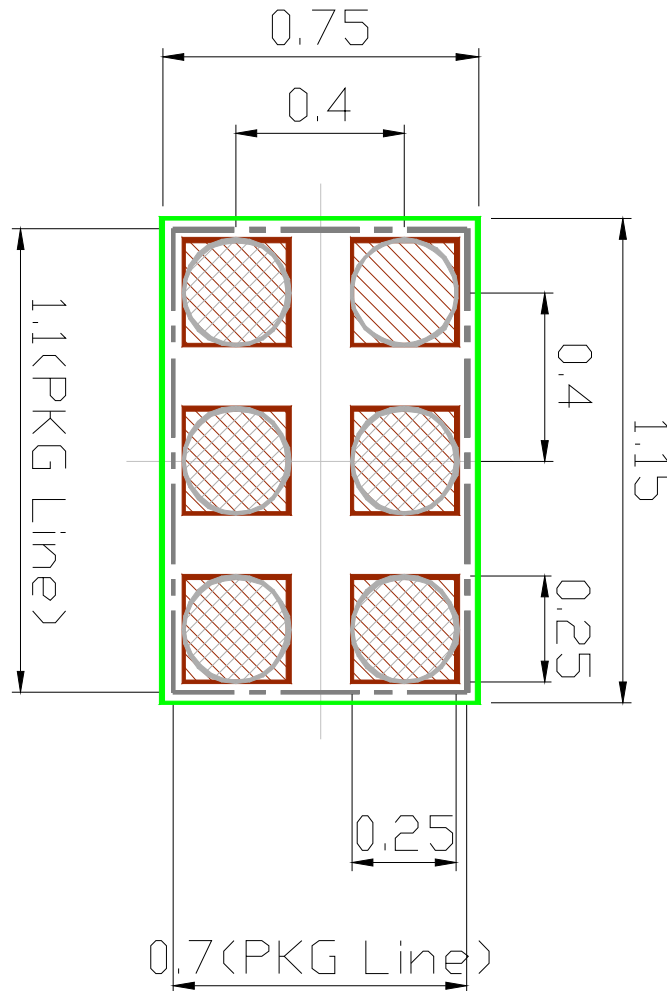

Unit : mm

■ PACKAGE OUTLINE (EPFFP6-X2)

TOP VIEW

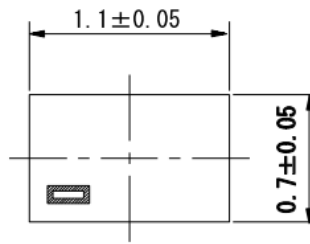

SIDE VIEW

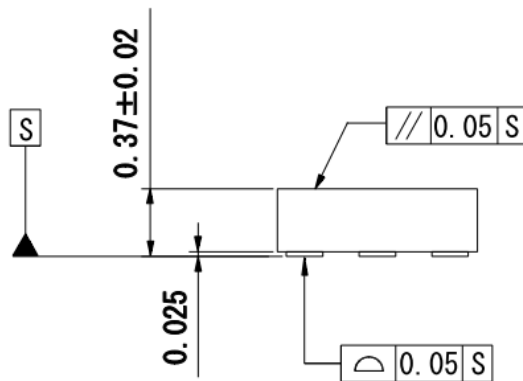

BOTTOM VIEW

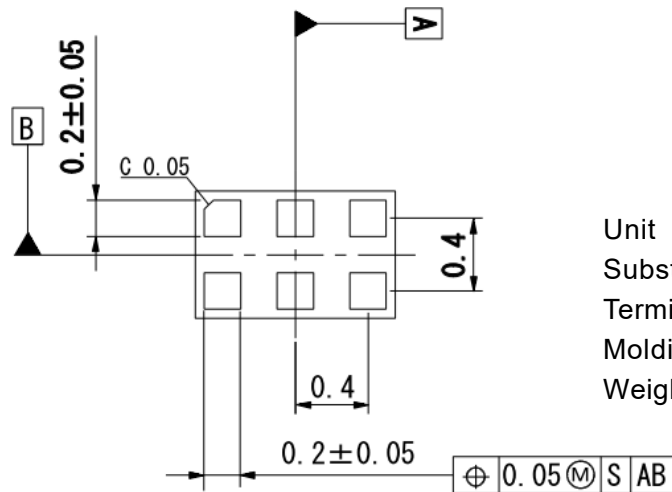

Unit	: mm
Substrate	: FR4
Terminal treat	: Ni/Pd/Au
Molding material	: Epoxy resin
Weight (typ.)	: 0.7mg

Cautions on using this product

This product contains Gallium-Arsenide (GaAs) which is a harmful material.

- Do NOT eat or put into mouth.
- Do NOT dispose in fire or break up this product.
- Do NOT chemically make gas or powder with this product.
- To waste this product, please obey the relating law of your country.

This product may be damaged with electric static discharge (ESD) or spike voltage. Please handle with care to avoid these damages.

[CAUTION]

The specifications on this databook are only given for information, without any guarantee as regards either mistakes or omissions.

The application circuits in this databook are described only to show representative usages of the product and not intended for the guarantee or permission of any right including the industrial rights.

1. The products and the product specifications described in this document are subject to change or discontinuation of production without notice for reasons such as improvement. Therefore, before deciding to use the products, please refer to our sales representatives for the latest information thereon.
2. The materials in this document may not be copied or otherwise reproduced in whole or in part without the prior written consent of us.
3. This product and any technical information relating thereto are subject to complementary export controls (so-called KNOW controls) under the Foreign Exchange and Foreign Trade Law, and related politics ministerial ordinance of the law. (Note that the complementary export controls are inapplicable to any application-specific products, except rockets and pilotless aircraft, that are insusceptible to design or program changes.) Accordingly, when exporting or carrying abroad this product, follow the Foreign Exchange and Foreign Trade Control Law and its related regulations with respect to the complementary export controls.
4. The technical information described in this document shows typical characteristics and example application circuits for the products. The release of such information is not to be construed as a warranty of or a grant of license under our or any third party's intellectual property rights or any other rights.
5. The products listed in this document are intended and designed for use as general electronic components in standard applications (office equipment, telecommunication equipment, measuring instruments, consumer electronic products, amusement equipment etc.). Those customers intending to use a product in an application requiring extreme quality and reliability, for example, in a highly specific application where the failure or misoperation of the product could result in human injury or death should first contact us.
 - Aerospace Equipment
 - Equipment Used in the Deep Sea
 - Power Generator Control Equipment (nuclear, steam, hydraulic, etc.)
 - Life Maintenance Medical Equipment
 - Fire Alarms / Intruder Detectors
 - Vehicle Control Equipment (automotive, airplane, railroad, ship, etc.)
 - Various Safety Devices
 - Traffic control system
 - Combustion equipment

In case your company desires to use this product for any applications other than general electronic equipment mentioned above, make sure to contact our company in advance. Note that the important requirements mentioned in this section are not applicable to cases where operation requirements such as application conditions are confirmed by our company in writing after consultation with your company.

6. We are making our continuous effort to improve the quality and reliability of our products, but semiconductor products are likely to fail with certain probability. In order to prevent any injury to persons or damages to property resulting from such failure, customers should be careful enough to incorporate safety measures in their design, such as redundancy feature, fire containment feature and fail-safe feature. We do not assume any liability or responsibility for any loss or damage arising from misuse or inappropriate use of the products.
7. The products have been designed and tested to function within controlled environmental conditions. Do not use products under conditions that deviate from methods or applications specified in this datasheet. Failure to employ the products in the proper applications can lead to deterioration, destruction or failure of the products. We shall not be responsible for any bodily injury, fires or accident, property damage or any consequential damages resulting from misuse or misapplication of the products.
8. **Quality Warranty**
 - 8-1. **Quality Warranty Period**

In the case of a product purchased through an authorized distributor or directly from us, the warranty period for this product shall be one (1) year after delivery to your company. For defective products that occurred during this period, we will take the quality warranty measures described in section 8-2. However, if there is an agreement on the warranty period in the basic transaction agreement, quality assurance agreement, delivery specifications, etc., it shall be followed.
 - 8-2. **Quality Warranty Remedies**

When it has been proved defective due to manufacturing factors as a result of defect analysis by us, we will either deliver a substitute for the defective product or refund the purchase price of the defective product.

Note that such delivery or refund is sole and exclusive remedies to your company for the defective product.
 - 8-3. **Remedies after Quality Warranty Period**

With respect to any defect of this product found after the quality warranty period, the defect will be analyzed by us. On the basis of the defect analysis results, the scope and amounts of damage shall be determined by mutual agreement of both parties. Then we will deal with upper limit in Section 8-2. This provision is not intended to limit any legal rights of your company.
9. Anti-radiation design is not implemented in the products described in this document.
10. The X-ray exposure can influence functions and characteristics of the products. Confirm the product functions and characteristics in the evaluation stage.
11. WLCSP products should be used in light shielded environments. The light exposure can influence functions and characteristics of the products under operation or storage.
12. Warning for handling Gallium and Arsenic (GaAs) products (Applying to GaAs MMIC, Photo Reflector). These products use Gallium (Ga) and Arsenic (As) which are specified as poisonous chemicals by law. For the prevention of a hazard, do not burn, destroy, or process chemically to make them as gas or power. When the product is disposed of, please follow the related regulation and do not mix this with general industrial waste or household waste.
13. Please contact our sales representatives should you have any questions or comments concerning the products or the technical information.



Nisshinbo Micro Devices Inc.

Official website

<https://www.nisshinbo-microdevices.co.jp/en/>

Purchase information

<https://www.nisshinbo-microdevices.co.jp/en/buy/>