

FMW-2106

Mar. 2008

Schottky Barrier Rectifier

General Description

FMW-2106 is a Schottky Barrier Diode, and has achieved low leakage current and low VF by selecting the best barrier metal.

Applications

- DC-DC converters
- AC adapter
- High frequency rectification circuit

Features

- Super-high speed & low noise switching.
- Low forward voltage drop.

Package

TO220F(3Pin)

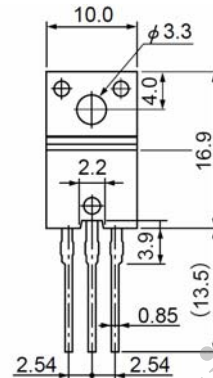

Key Specifications

Symbol	Unit	Rating	Conditions
V_{RM}	V	60	
V_F	V	0.70	$I_F=5.0A$
$I_{F(AV)}$	A	10	

Typical Characteristics

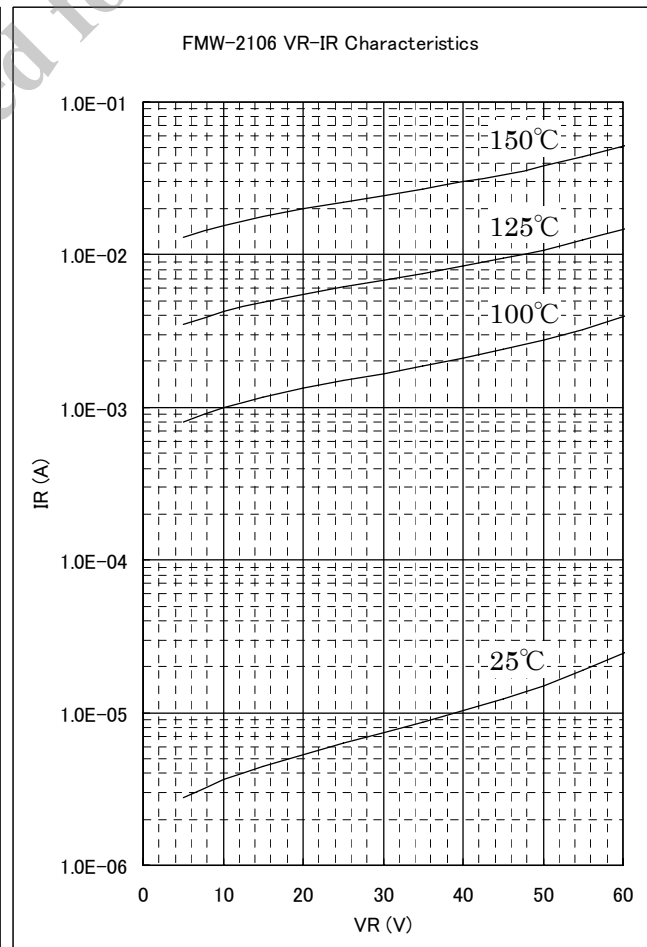
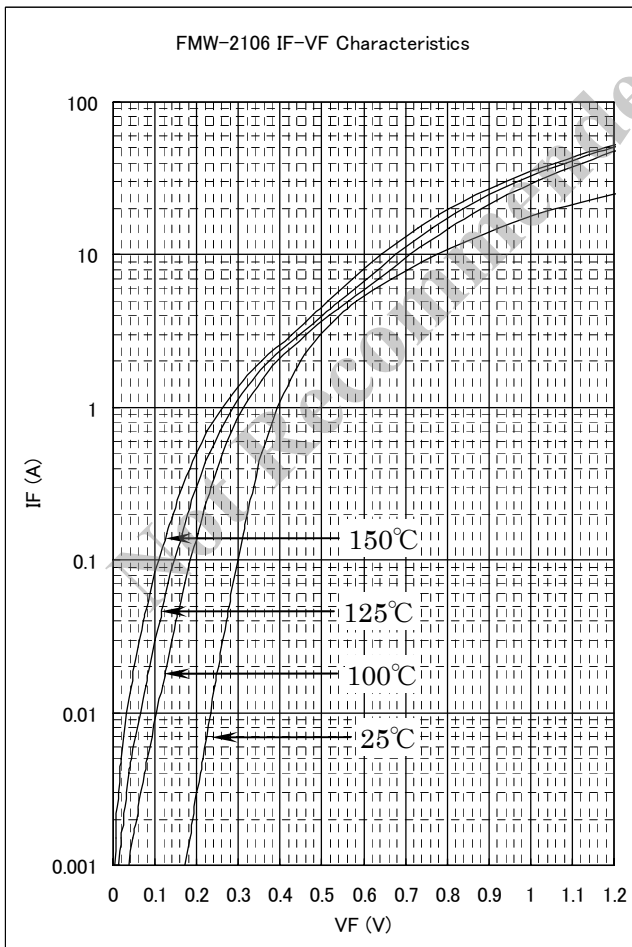

The information included herein is believed to be accurate and reliable. However, SANKEN ELECTRIC CO., LTD assumes no responsibility for its use ; nor for any infringements of patents or other rights of third parties that may result from its use.

FMW-2106

Mar. 2008

Schottky Barrier Rectifier

*** Absolute maximum ratings**

No.	Parameter	Symbol	Unit	Rating	Conditions
1	Transient Peak Reverse Voltage	V_{RSM}	V	60	
2	Peak Reverse Voltage	V_{RM}	V	60	
3	Average Forward Current	$I_{F(AV)}$	A	10	
4	Peak Surge Forward Current	I_{FSM}	A	100	Half sinewave, one shot
5	I^2t Limiting Value	I^2t	A^2s	50	$1msec < t < 10msec$
6	Junction Temperature	T_j	$^{\circ}C$	-40 to +150	
7	Storage Temperature	T_{stg}	$^{\circ}C$	-40 to +150	

No.1,2,4&5 show ratings per one chip.

*** Electrical characteristics ($T_a=25^{\circ}C$, unless otherwise specified)**

No.	Parameter	Symbol	Unit	Rating	Conditions
1	Forward Voltage Drop	V_F	V	0.70 max.	$I_F=5.0A$
2	Reverse Leakage Current	I_R	mA	3.0 max.	$V_R=V_{RM}$
3	Reverse Leakage Current Under High Temperature	$H \cdot I_R$	mA	125 max.	$V_R=V_{RM}, T_j=150^{\circ}C$
4	Thermal Resistance	$R_{th(j-c)}$	$^{\circ}C/W$	4.0 max.	Between Junction and case

No.1,2,&3 show characteristics per one chip.

The information included herein is believed to be accurate and reliable. However, SANKEN ELECTRIC CO., LTD assumes no responsibility for its use ; nor for any infringements of patents or other rights of third parties that may result from its use.

FMW-2106

Schottky Barrier Rectifier

Mar. 2008

★ **Characteristics**

Forward Power Dissipation

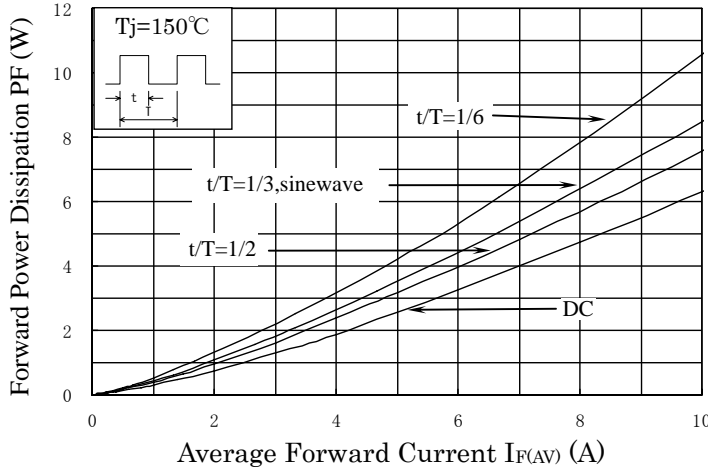

Reverse Power Dissipation

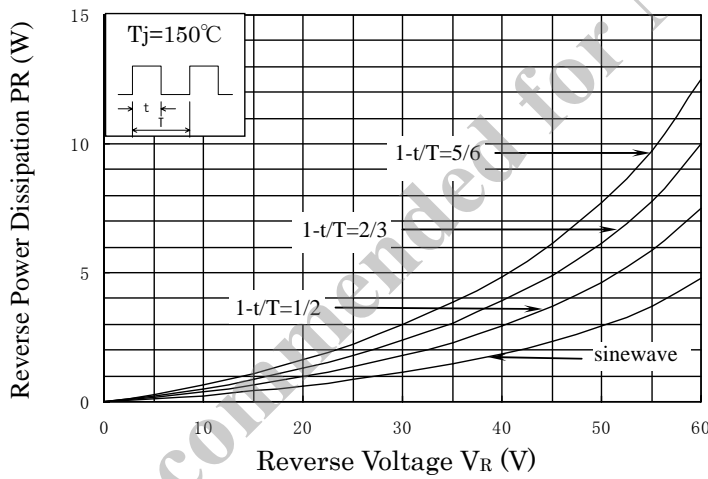

Current Derating $V_R=60\text{V}$

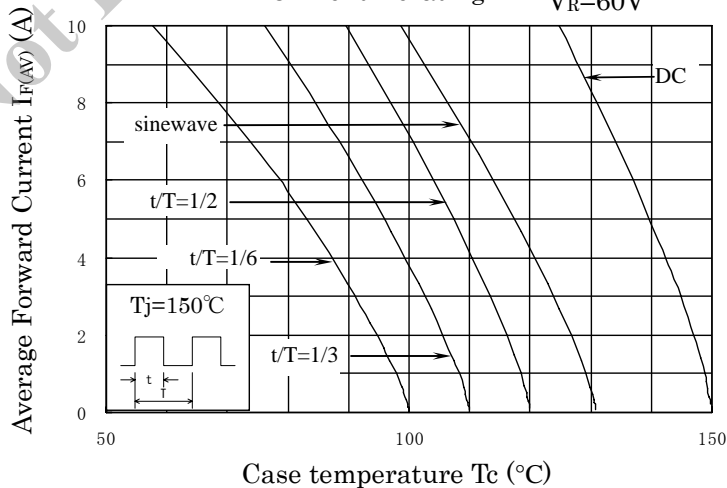

FMW-2106

Mar. 2008

Schottky Barrier Rectifier

★ Outline drawings, mm

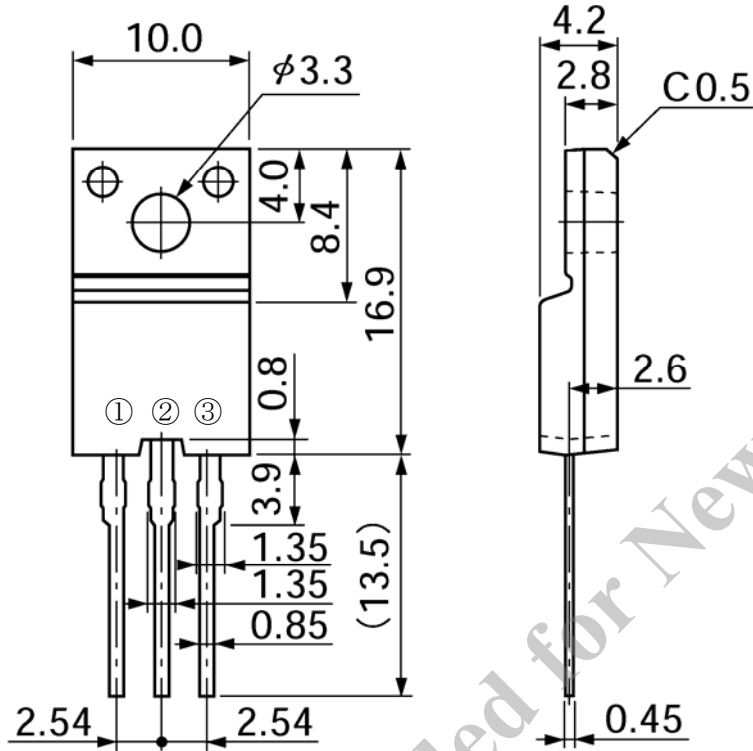

tolerance:±0.2

★ Connection Diagram

