

# Linear LED Drivers with Single-Wire Digital Interface

## FAN5622, FAN5624, FAN5626

### Description

The FAN5622, FAN5624, and FAN5626 are two-, four-, and six-channel current-sink linear LED drivers used to backlight the main LCD displays or keypads in mobile electronics, such as cellular phone handsets.

A very low dropout of 50 mV allows driving LEDs without any inductors or switch capacitors. The brightness levels of the LED outputs are programmed through single-wire digital control interface. The user can program 32 linear dimming steps and turn on and off the LEDs through this interface by applying digital pulses.

The FAN562x family of linear LED drivers provides high efficiency due to the low drop-out voltage of the LED driver. Good matching between different channels of LED output is provided across the entire 32 dimming steps. These LED drivers also integrate short circuit, under-voltage, and thermal protection to ensure for a more robust solution.

The FAN5622, FAN5624, and FAN5626 are available in very small form-factor packages: 6-pin Super SOT23, 10-lead UMLP, and 10-lead MicroPak™ MLP, respectively.

### Features

- Family of Three Linear Current-Sink LED Drivers that Support 2, 4, or 6 LED Outputs
- Current Sink Driver for Each LED Output:
  - ◆ 30 mA Maximum Output Current
  - ◆ 50 mV Drop-out at 15 mA  $I_{OUT}$
  - ◆ Better than 3% Matching between Channels
  - ◆ External  $R_{SET}$
- Single-Wire Digital Control Interface for Easy Programming
  - ◆ 32 Linear Steps of Dimming Control
- Less than 1  $\mu$ A Shutdown Current
- Short-Circuit, Under-Voltage, and Thermal Protection
- Wide Input Voltage Range: 2.7 to 5.5 V
- Small Form-Factor Packages:
- These are Pb-Free Devices
  - ◆ FAN5622: 6-Pin Super SOT23
  - ◆ FAN5624: 10-Lead 1.4x1.8x0.55 mm UMLP
  - ◆ FAN5626: 10-Lead 1.6x2.1x0.55 mm MicroPak MLP

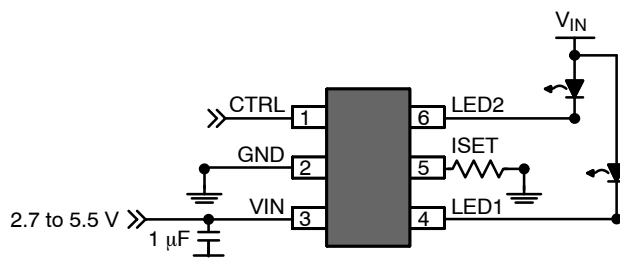

Figure 1. Typical Application of FAN5622



ON Semiconductor®

[www.onsemi.com](http://www.onsemi.com)

		MARKING DIAGRAM
	TSOT23 6-Lead CASE 419BL	
	UQFN10 1.4x1.8, 0.4P CASE 523BC	
	UQFN10 (MICROPAK), 1.6X2.1, 0.5P CASE 523AZ	

622, 24, 26 = Specific Device Code  
 &Y = Binary Calendar Year Coding Scheme  
 &O = Plant Code Identifier  
 &C = Single Digit Die Run Code  
 &V = Eight-Week Binary Datacoding Scheme  
 &K = 2-Digits Lot Run Traceability Code  
 &2 = 2-Digit Date Code  
 &Z = Assembly Plant Code

### ORDERING INFORMATION

See detailed ordering and shipping information on page 9 of this data sheet.

### Applications

- Mobile Handsets
- Mobile Internet Devices
- PMP and MP3 Players
- LCD Modules

# FAN5622, FAN5624, FAN5626

## APPLICATIONS DIAGRAMS

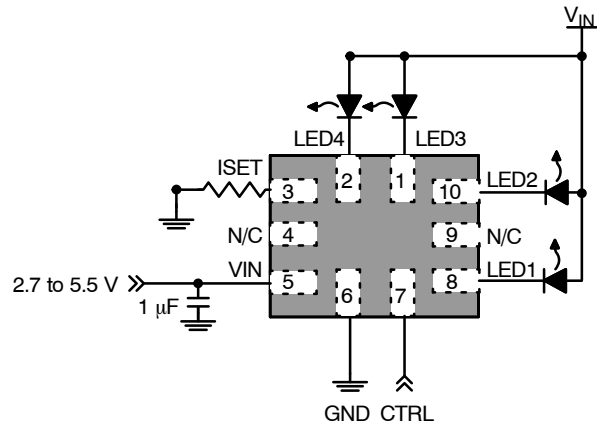

Figure 2. FAN5624 Typical Application for 4 LEDs

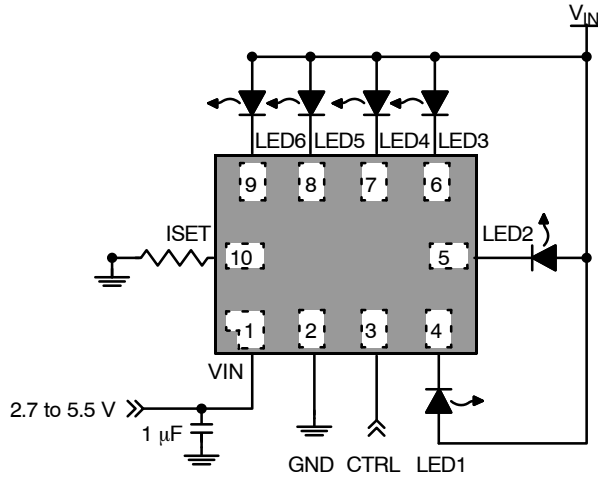

Figure 3. FAN5626 Typical Application for 6 LEDs

## BLOCK DIAGRAM

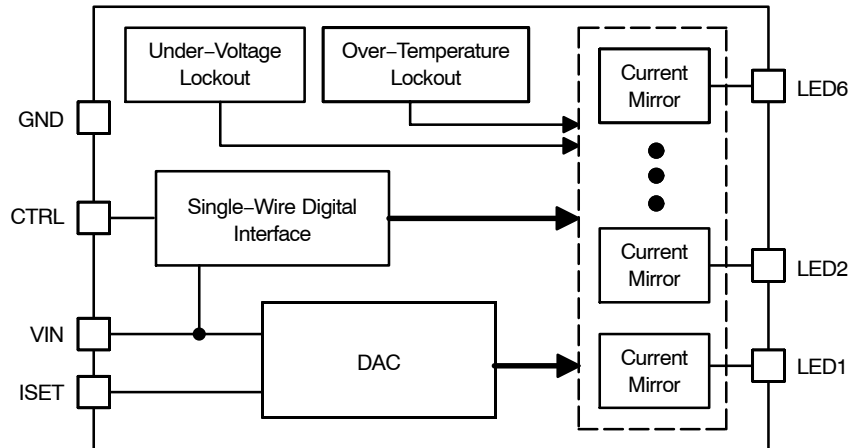

Figure 4. Block Diagram

# FAN5622, FAN5624, FAN5626

## PIN CONFIGURATION

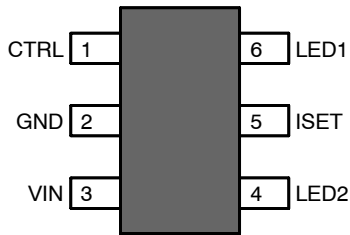

Figure 5. FAN5622: 6-Pin SSOT23, Top View

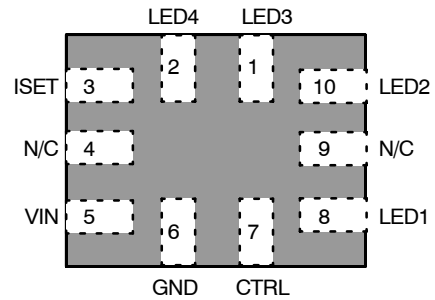

Figure 6. FAN5624: 10-Lead UMLP, Top View

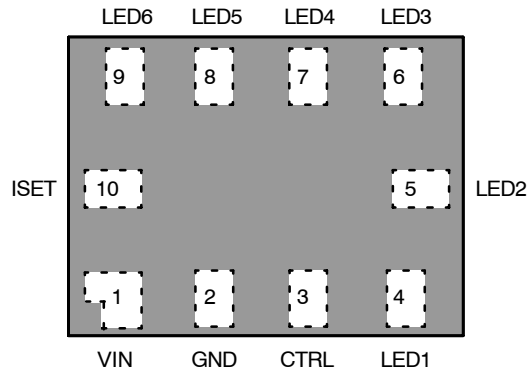

Figure 7. FAN5626: 10-Lead MicroPak MLP, Top View

### PIN DEFINITIONS

Pin No.			Name	Description
FAN5622 SSOT23-6	FAN5624 UMLP10	FAN5626 MicroPak MLP10		
3	5	1	VIN	<i>Input Voltage.</i> Connect to 2.7 – 5.5 V <sub>DC</sub> input power source.
2	6	2	GND	<i>Ground</i>
5	3	10	ISET	<i>LED Current Setting.</i> Full-scale LED current is set by tying this pin through a resistor (R <sub>SET</sub> ) to GND.
1	7	3	CTRL	<i>Control pin.</i> Program dimming levels by driving pin with digital pulses. This pin cannot be left floating.
6	8	4	LED1	<i>LED Cathode #1.</i> LED current sink output.
4	10	5	LED2	<i>LED Cathode #2.</i> LED current sink output.
	1	6	LED3	<i>LED Cathode #3.</i> LED current sink output.
	2	7	LED4	<i>LED Cathode #4.</i> LED current sink output.
		8	LED5	<i>LED Cathode #5.</i> LED current sink output.
		9	LED6	<i>LED Cathode #6.</i> LED current sink output.
	4, 9		N/C	<i>No Connect</i>

# FAN5622, FAN5624, FAN5626

## ABSOLUTE MAXIMUM RATINGS

Symbol	Parameter	Min	Max	Unit
V <sub>CC</sub>	VIN Pin	-0.3	6.0	V
	Other Pins (Note 1)	-0.3	V <sub>IN</sub> + 0.3	V
ESD	Electrostatic Discharge Protection Level	Human Body Model per JESD22-A114	3.0	kV
		Charged Device Model per JESD22-C101	1.5	kV
T <sub>J</sub>	Junction Temperature	-40	+150	°C
T <sub>STG</sub>	Storage Temperature	-65	+150	°C
T <sub>L</sub>	Lead Soldering Temperature, 10 Seconds	-	+260	°C

Stresses exceeding those listed in the Maximum Ratings table may damage the device. If any of these limits are exceeded, device functionality should not be assumed, damage may occur and reliability may be affected.

1. Lesser of 6.0 V or V<sub>IN</sub> + 0.3 V.

## RECOMMENDED OPERATING CONDITIONS

Symbol	Parameter	Min	Max	Unit
V <sub>IN</sub>	Power Supply Voltage Range	2.7	5.5	V
T <sub>A</sub>	Operating Ambient Temperature Range	-40	+85	°C
T <sub>J</sub>	Operating Junction Temperature Range	-40	+125	°C
I <sub>LED(FS)</sub>	Full-Scale LED Current	5	30	mA

Functional operation above the stresses listed in the Recommended Operating Ranges is not implied. Extended exposure to stresses beyond the Recommended Operating Ranges limits may affect device reliability.

**THERMAL PROPERTIES** (Junction-to-ambient thermal resistance is a function of application and board layout. This data is measured with boards in accordance to JEDEC standard JESD51. Special attention must be paid not to exceed junction temperature T<sub>J(max)</sub> at a given ambient temperature T<sub>A</sub>.)

Symbol	Parameter	Typical	Unit
θ <sub>JA</sub>	Junction-to-Ambient Thermal Resistance, SSOT23-6 Package	235	°C/W
	Junction-to-Ambient Thermal Resistance, UMLP10 Package (Note 2)	287	°C/W
	Junction-to-Ambient Thermal Resistance, MicroPak MLP10 package (Note 3)	220	°C/W

2. Recommended not to exceed 132 mW of maximum power dissipation.

3. Recommended not to exceed 198 mW of maximum power dissipation.

## FAN5622, FAN5624, FAN5626

**ELECTRICAL SPECIFICATIONS** ( $V_{IN} = 2.7\text{ V to }5.5\text{ V}$ ,  $R_{SET} = 19.10\text{ k}\Omega$ ,  $T_A = -40^\circ\text{C to }+85^\circ\text{C}$ ,  $V_f = 2.5\text{ V to }[3.5\text{ V or }V_{IN} - 0.1\text{ V}]$ , whichever is smaller. Typical values are at  $T_A = 25^\circ\text{C}$ ,  $V_{IN} = 3.6\text{ V}$ , and  $V_f = 3.2\text{ V}$ .)

Symbol	Parameter	Condition	Min	Typ	Max	Unit
<b>POWER SUPPLIES</b>						
$I_{SD}$	Shutdown Supply Current	$V_{IN} = 3.6\text{ V}$ , CTRL = 0	–	0.3	1.0	$\mu\text{A}$
$I_{IN}$	Operating Supply Current	FAN5622: $V_{IN} = 3.6\text{ V}$ , $I_{LED} = 0\text{ mA}$	–	0.4	0.8	mA
		FAN5624: $V_{IN} = 3.6\text{ V}$ , $I_{LED} = 0\text{ mA}$	–	0.6	1.0	mA
		FAN5626: $V_{IN} = 3.6\text{ V}$ , $I_{LED} = 0\text{ mA}$	–	0.8	1.2	mA
$I_{IH}$	Control Pin Input Current	CTRL = 1.8 V	–	1	250	nA
$V_{UVLO}$	Under-Voltage Lockout Threshold	$V_{IN}$ Rising	–	2.50	2.70	V
		$V_{IN}$ Falling	2.10	2.30	2.50	V

### REGULATION

$I_{FS\_LEDX(MAX)}$	Full-Scale LED Output Current	$I_{LEDx} = 30\text{ mA}$ ; x = 1 to 6	5	–	30	mA
$I_{LED}$	Absolute Current Accuracy	$V_{IN} = 2.85\text{ V} - 4.5\text{ V}$ ; $V_{CATH} = 0.15$ to (1.2 V or $V_{IN} = 2.55\text{ V}$ , Whichever is Smaller); Full-Scale Current 5 – 30 mA, $T_A = 25^\circ\text{C}$	–10	–	+10	%
$I_{LED\ MATCH}$	LED Current Matching (Note 4)	$I_{LEDx} = 15\text{ mA}$ ; $V_{LEDx} = 0.4\text{ V}$ , $T_A = 25^\circ\text{C}$	–3	–	+3	%
$V_{ISET}$	$I_{SET}$ Drive Voltage	$9.53\text{ k}\Omega \leq R_{SET} \leq 56.2\text{ k}\Omega$	–	1.20	–	V
$I_{RATIO}$	Current Mirror Ratio from ISET Pin	$9.53\text{ k}\Omega \leq R_{SET} \leq 56.2\text{ k}\Omega$	–	240	–	
$\Delta I_{OUT\_LOAD}$	$I_{OUT}$ Load Regulation	$V_{IN} = 3.6\text{ V}$ , $I_{LEDx} = 15\text{ mA}$ , LED $V_f = 2.7$ to $3.5\text{ V}$	–3	–	+3	%
$\Delta I_{OUT\_LINE}$	$I_{OUT}$ Line Regulation	$V_{IN} = 2.7$ to $4.8\text{ V}$ , $I_{LEDx} = 15\text{ mA}$ , $V_{CATH} = 0.5\text{ V}$	–4	–	+4	%
$V_{DROPOUT}$	Dropout Voltage	$V_{IN} = 3.6\text{ V}$ ; $I_{LED} = 15\text{ mA}$ , –10% $I_{LED}$ Drop	–	50	–	mV
		$V_{IN} = 3.6\text{ V}$ ; $I_{LED} = 30\text{ mA}$ , –10% $I_{LED}$ Drop	–	60	–	
TSD	Thermal Shutdown	Rising Temperature at Junction	–	150	–	$^\circ\text{C}$
		Hysteresis	–	20	–	

### LOGIC INPUT (CTRL)

$V_{IH}$	HIGH-Level Input Voltage		1.2	–	–	V
$V_{IL}$	LOW-Level Input Voltage		–	–	0.4	V
$T_{LO}$	CTRL LOW Time for Dimming	$V_{IN} = 3.6\text{ V}$ ; See Figure 17	0.5	–	300	$\mu\text{s}$
$T_{HI}$	Time Delay between Steps	$V_{IN} = 3.6\text{ V}$ ; See Figure 17	0.5	–	–	$\mu\text{s}$
$T_{ON}$	CTRL HIGH to Turn-On Delay	$V_{IN} = 3.6\text{ V}$ ; See Figure 17	–	250	–	$\mu\text{s}$
$T_{SD}$	CTRL LOW, Shutdown Pulse Width	$V_{IN} = 3.6\text{ V}$ ; from Falling Edge of CTRL	1	–	–	ms

Product parametric performance is indicated in the Electrical Characteristics for the listed test conditions, unless otherwise noted. Product performance may not be indicated by the Electrical Characteristics if operated under different conditions.

4. For the two, four, and six LED current sinks of FAN5622, FAN5624, and FAN5626 respectively; the following are determined: the maximum sink current of the two, four, and six LED outputs (MAX); the minimum sink current of the two, four, and six outputs (MIN); and the average sink current (AVG). For all of the LED outputs, two matching numbers are calculated:  $(MAX - AVG) / AVG$  and  $(AVG - MIN) / AVG$ . The largest number of the two (worst case) is considered the matching figure for the part. The matching figure for a given part is considered to be the highest matching figure of all LED outputs. The typical specification provided is the most likely norm of the matching figure for all parts.

TYPICAL PERFORMANCE CHARACTERISTICS

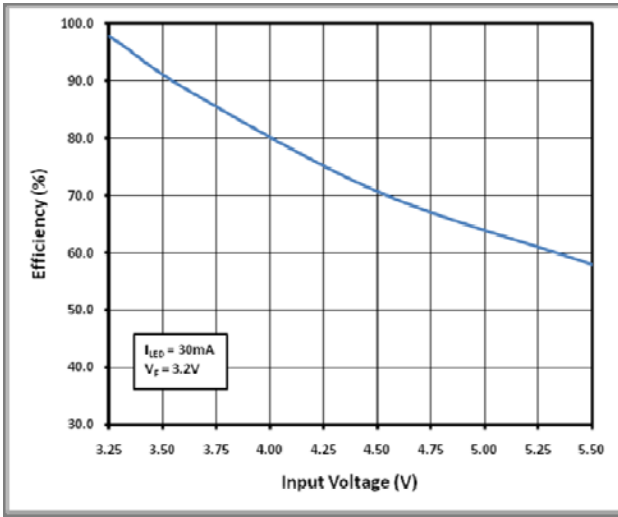

Figure 8. Efficiency vs. Input Voltage where LED  $V_F = 3.2V$

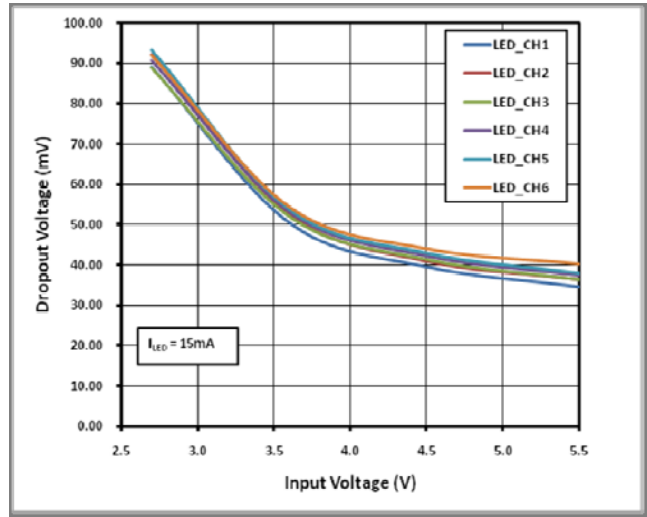

Figure 9. Dropout Voltage vs. Input Voltage

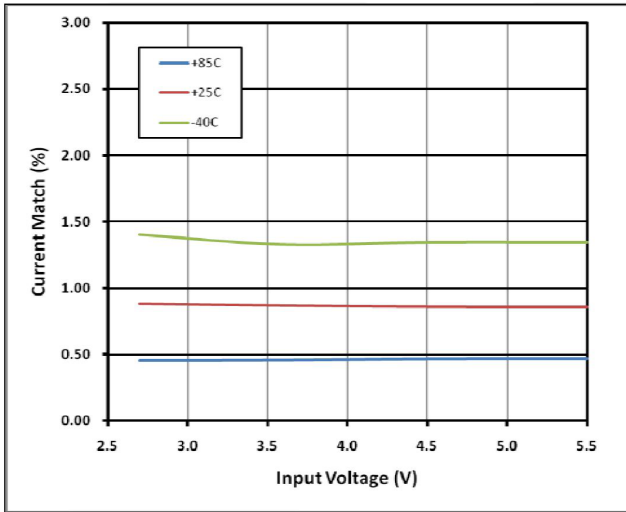

Figure 10. Current Match of Channels vs. Input Voltage

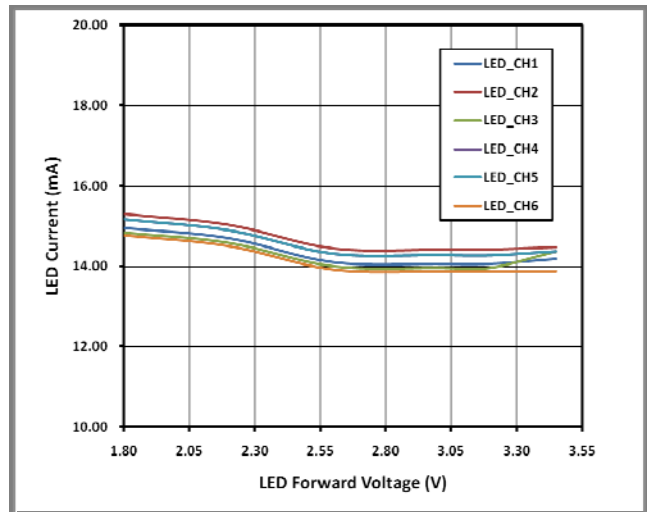

Figure 11. Load Regulation at 15 mA/Output

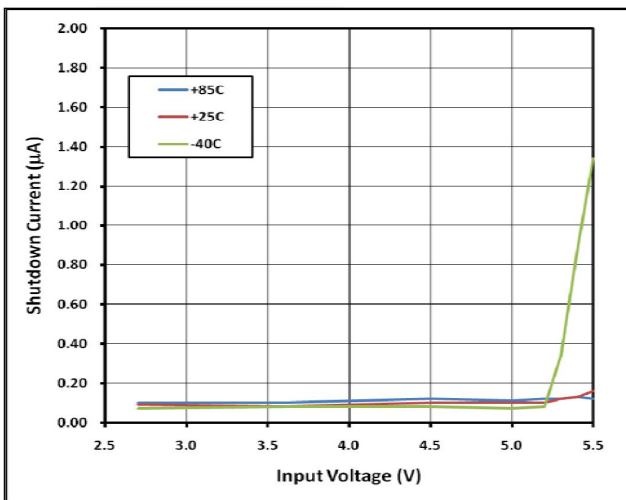

Figure 12. Shutdown Current vs. Input Voltage

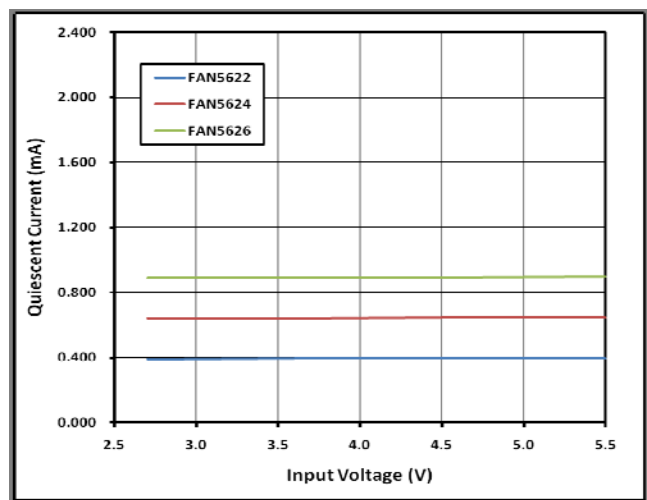

Figure 13. Quiescent Current vs. Input Voltage

# FAN5622, FAN5624, FAN5626

## TYPICAL PERFORMANCE CHARACTERISTICS (Continued)

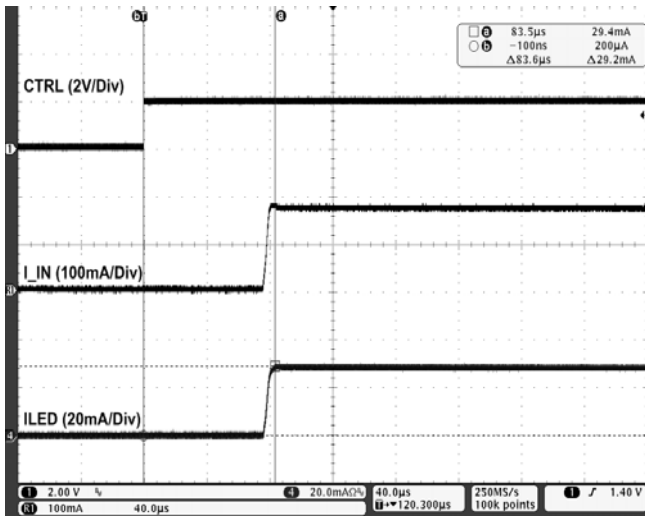

Figure 14. Startup Waveform for FAN5626

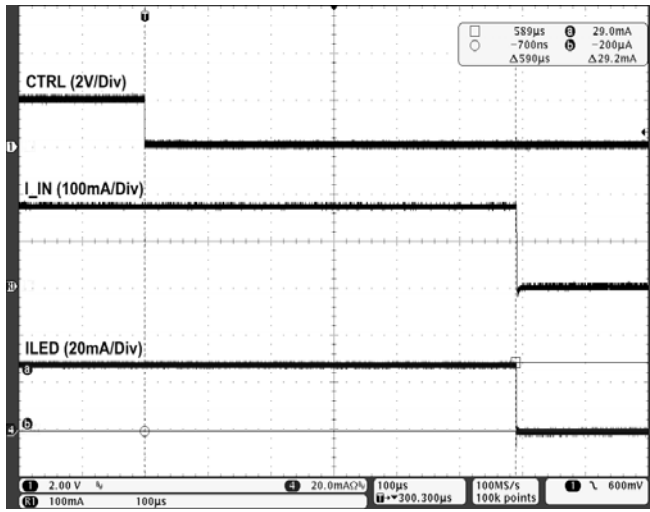

Figure 15. Shutdown Waveform for FAN5626

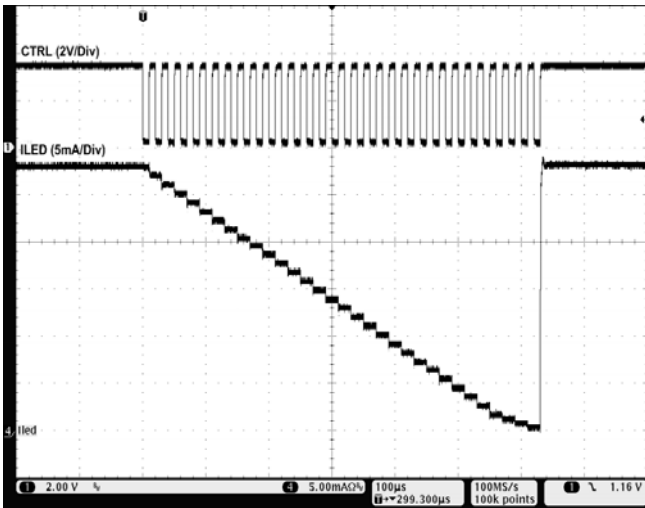

Figure 16. Dimming Operation

CIRCUIT DESCRIPTION

The FAN5622, FAN5624, and FAN5626 are a family of current-sink linear LED driver ICs able to drive two, four, and six LEDs respectively. These three devices are powered directly from 2.7 V to 5.5 V supply and all the channels are controlled via the integrated current sinks from the external power source. Designed with a very low drop-out voltage, the FAN562x products can operate close to the input supply voltage without the need for additional inductive boost or capacitive switching circuitry.

All three devices require only two additional discrete passive components: a single 1  $\mu$ F input ceramic capacitor and a resistor ( $R_{SET}$ ) to set the maximum current for the LEDs. Each current-sink output provides constant current and can drive the LEDs up to 30 mA. ON Semiconductor’s TinyWire single-wire digital interface enables these LED drivers to program the brightness level of the LEDs in 32 linear steps.

**Setting Maximum Current**

The maximum LED current of the FAN5622, FAN5624, and FAN5626 is programmed by an external resistor called RSET. The maximum full-scale LED current for all three LED drivers is 30 mA and it can go as low as 5 mA. The FAN562x products also operate below 5 mA full-scale LED current by using a larger RSET value. However, the LED channel accuracy and matching specifications are guaranteed. Table 1 shows the RSET resistor values for several full-scale current levels.

**Table 1. MAXIMUM LED CURRENT SETTINGS BY RESISTOR**

$I_{LED}$ (mA)	$R_{SET}$ (k $\Omega$ )
5	56.20
10	28.70
15	19.10
20	14.30
25	11.50
30	9.53

**Digital Interface & Dimming Control**

The FAN5622, FAN5624, and FAN5626 implement a simple single-wire digital interface to program the LED brightness to one of thirty two (32) levels spaced in linear steps. To maintain the brightness of the LEDs at a specific dimming level, the digital pulse signal to the CTRL pin should be held HIGH for that last pulse. It is held HIGH for as long as desired to keep the LEDs illuminated at that specific brightness level.

Table 2 outlines the dimming levels while Figure 17 shows how to change the dimming levels.

**Table 2. BRIGHTNESS CONTROL LEVELS ( $R_{SET} = 19.10$  k $\Omega$ )**

Dimming Level	Current Level	$I_{LED}$ (mA)
1	1.67%	0.25
2	3.33%	0.50
3	5.00%	0.75
4	6.67%	1.00
5	10.00%	1.50
6	13.33%	2.00
7	16.67%	2.50
8	20.00%	3.00
9	23.33%	3.50
10	26.67%	4.00
11	30.00%	4.50
12	33.33%	5.00
13	36.67%	5.50
14	40.00%	6.00
15	43.33%	6.50
16	46.67%	7.00
17	50.00%	7.50
18	53.33%	8.00
19	56.67%	8.50
20	60.00%	9.00
21	63.33%	9.50
22	66.67%	10.00
23	70.00%	10.50
24	73.33%	11.00
25	76.67%	11.50
26	80.00%	12.00
27	83.33%	12.50
28	86.67%	13.00
29	90.00%	13.50
30	93.33%	14.00
31	96.67%	14.50
32	100.00%	15.00



# FAN5622, FAN5624, FAN5626

## Digital Dimming Control

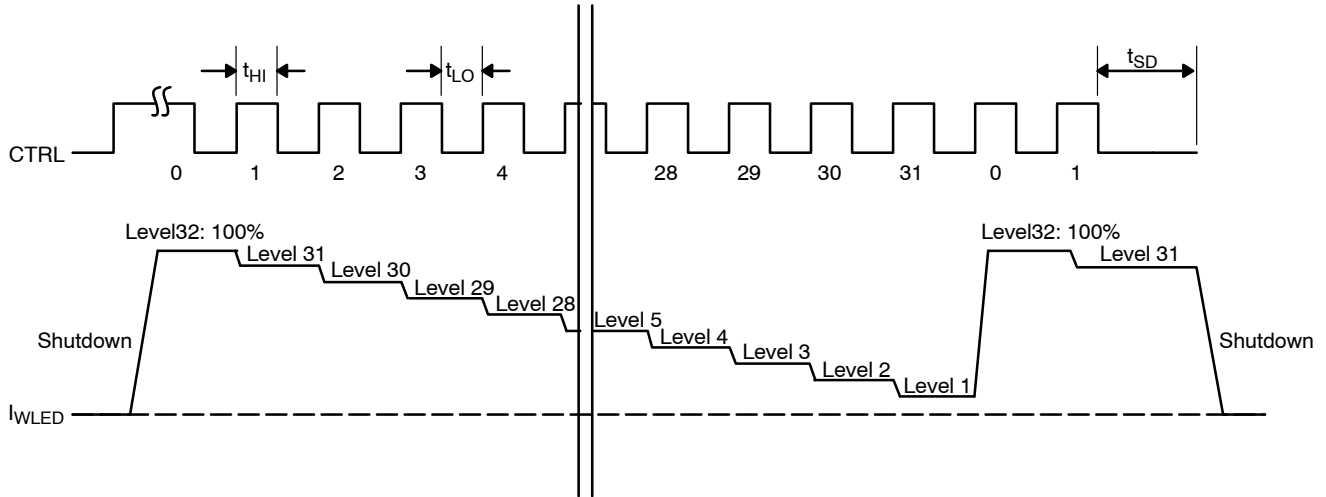

Figure 17. Digital Pulse Dimming Control Diagram

### ORDERING INFORMATION

Part Number	# of Channels	Temperature Range	Package	Shipping†
FAN5622SX	2	-40 to 85°C	6-Lead, SUPERSOT™ 6, JEDEC MO-193, 1.6 mm Wide (Pb-Free)	3000 / Tape & Reel
FAN5624UMPX	4	-40 to 85°C	10-Lead, Ultrathin Molded Leadless Package (UMLP) (Pb-Free)	5000 / Tape & Reel
FAN5626LX	6	-40 to 85°C	10-Lead, MicroPak, JEDEC MO255, 1.6 X 2.1 mm (Pb-Free)	5000 / Tape & Reel

†For information on tape and reel specifications, including part orientation and tape sizes, please refer to our Tape and Reel Packaging Specifications Brochure, BRD8011/D.

MicroPak and SUPERSOT are trademarks of Semiconductor Components Industries, LLC (SCILLC) or its subsidiaries in the United States and/or other countries.

# MECHANICAL CASE OUTLINE

## PACKAGE DIMENSIONS

ON Semiconductor®



1  
SCALE 2:1

### TSOT23 6-Lead CASE 419BL ISSUE A

DATE 31 AUG 2020

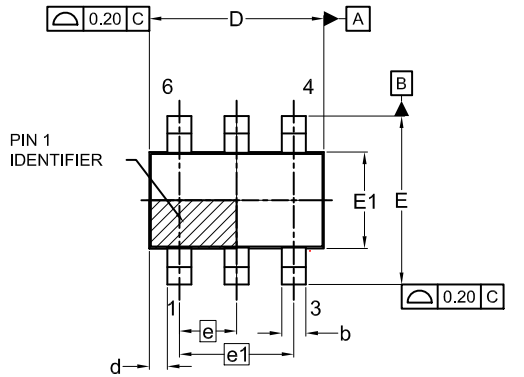

TOP VIEW



FRONT VIEW



DETAIL A

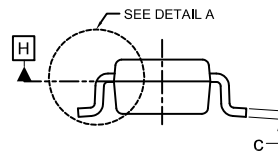

SIDE VIEW

SYMM  
⌀

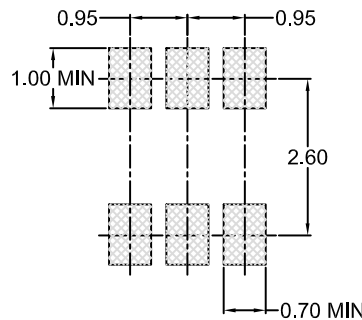

LAND PATTERN  
RECOMMENDATION

\*FOR ADDITIONAL INFORMATION ON OUR  
Pb-FREE STRATEGY AND SOLDERING DETAILS,  
PLEASE DOWNLOAD THE ON SEMICONDUCTOR  
SOLDERING AND MOUNTING TECHNIQUES  
REFERENCE MANUAL, SOLDERRM/D.

NOTES:

1. DIMENSIONING AND TOLERANCING PER ASME Y14.5M, 2009.
2. CONTROLLING DIMENSION: MILLIMETERS
3. DIMENSIONS D AND E1 DO NOT INCLUDE MOLD FLASH, PROTRUSIONS, OR GATE BURRS. MOLD FLASH, PROTRUSIONS OR GATE BURRS SHALL NOT EXCEED 0.25MM PER END. DIMENSIONS D AND E1 ARE DETERMINED AT DATUM H.
4. SEATING PLANE IS DEFINED BY THE TERMINALS. "A1" IS DEFINED AS THE DISTANCE FROM THE SEATING PLANE TO THE LOWEST POINT ON THE PACKAGE BODY.

DIM	MILLIMETERS		
	MIN.	NOM.	MAX.
A	0.90	1.00	1.10
A1	0.00	0.05	0.10
A2	0.70	0.85	1.00
A3	0.25 BSC		
b	0.25	0.38	0.50
c	0.10	0.18	0.26
D	2.80	2.95	3.10
d	0.30 REF		
E	2.50	2.75	3.00
E1	1.30	1.50	1.70
e	0.95 BSC		
e1	1.90 BSC		
L1	0.60 REF		
L2	0.20	0.40	0.60
⌀	0°	--	10°

#### GENERIC MARKING DIAGRAM\*



XXX = Specific Device Code  
M = Date Code  
▪ = Pb-Free Package

(Note: Microdot may be in either location)

\*This information is generic. Please refer to device data sheet for actual part marking. Pb-Free indicator, "G" or microdot "▪", may or may not be present. Some products may not follow the Generic Marking.

DOCUMENT NUMBER:	98AON83292G	Electronic versions are uncontrolled except when accessed directly from the Document Repository. Printed versions are uncontrolled except when stamped "CONTROLLED COPY" in red.
DESCRIPTION:	TSOT23 6-Lead	PAGE 1 OF 1

ON Semiconductor and ON are trademarks of Semiconductor Components Industries, LLC dba ON Semiconductor or its subsidiaries in the United States and/or other countries. ON Semiconductor reserves the right to make changes without further notice to any products herein. ON Semiconductor makes no warranty, representation or guarantee regarding the suitability of its products for any particular purpose, nor does ON Semiconductor assume any liability arising out of the application or use of any product or circuit, and specifically disclaims any and all liability, including without limitation special, consequential or incidental damages. ON Semiconductor does not convey any license under its patent rights nor the rights of others.

# MECHANICAL CASE OUTLINE

## PACKAGE DIMENSIONS

ON Semiconductor®

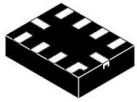

### UQFN10 (MICROPAK™), 1.6X2.1, 0.5P CASE 523AZ ISSUE A

DATE 11 DEC 2019

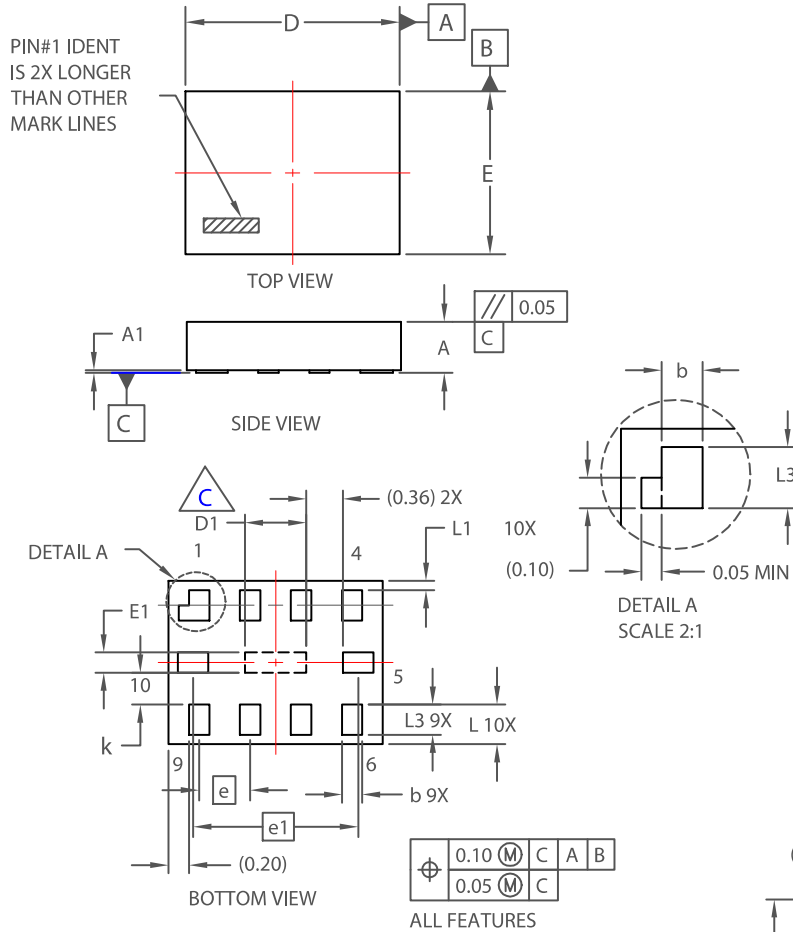

NOTES:

- A. PACKAGE CONFORMS TO JEDEC REGISTRATION MO-255, VARIATION UABD.
- B. DIMENSIONS ARE IN MILLIMETERS.
- C. PRESENCE OF CENTER PAD IS PACKAGE SUPPLIER DEPENDENT. IF PRESENT IT IS NOT INTENDED TO BE SOLDERED AND HAS A BLACK OXIDE FINISH.
- D. DIMENSIONS WITHIN ( ) ARE UNCONTROLLED.

DIM	MIN.	NOM.	MAX.
A	0.50	0.55	0.65
A1	0.00	0.025	0.05
b	0.15	0.20	0.25
D	2.00	2.10	2.20
D1	0.55	0.60	0.65
E	1.50	1.60	1.70
E1	0.15	0.20	0.25
e	0.50 BSC		
e1	1.62 BSC		
k	0.20	--	--
L	0.25	0.30	0.42
L1	0.00	0.09	0.15
L3	0.25	0.30	0.35

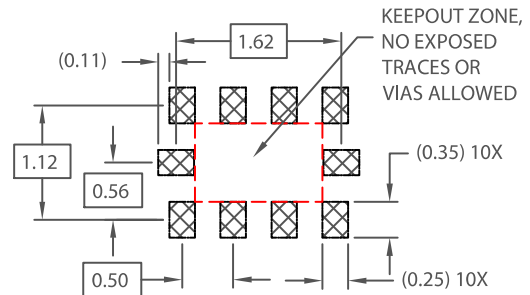

RECOMMENDED MOUNTING FOOTPRINT\*

\*FOR ADDITIONAL INFORMATION ON OUR Pb-FREE STRATEGY AND SOLDERING DETAILS, PLEASE DOWNLOAD THE ON SEMICONDUCTOR SOLDERING AND MOUNTING TECHNIQUES REFERENCE MANUAL, SOLDERRM/D.

<b>DOCUMENT NUMBER:</b>	<b>98AON13592G</b>	Electronic versions are uncontrolled except when accessed directly from the Document Repository. Printed versions are uncontrolled except when stamped "CONTROLLED COPY" in red.
<b>DESCRIPTION:</b>	<b>UQFN10 (MICROPAK™), 1.6X2.1, 0.5P</b>	<b>PAGE 1 OF 1</b>

ON Semiconductor and ON are trademarks of Semiconductor Components Industries, LLC dba ON Semiconductor or its subsidiaries in the United States and/or other countries. ON Semiconductor reserves the right to make changes without further notice to any products herein. ON Semiconductor makes no warranty, representation or guarantee regarding the suitability of its products for any particular purpose, nor does ON Semiconductor assume any liability arising out of the application or use of any product or circuit, and specifically disclaims any and all liability, including without limitation special, consequential or incidental damages. ON Semiconductor does not convey any license under its patent rights nor the rights of others.

# MECHANICAL CASE OUTLINE PACKAGE DIMENSIONS

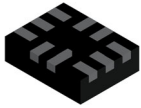

**UQFN10 1.4x1.8, 0.4P**  
CASE 523BC  
ISSUE B

DATE 13 MAY 2022

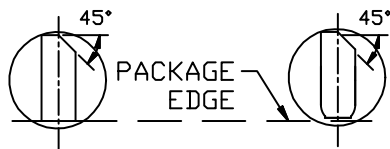
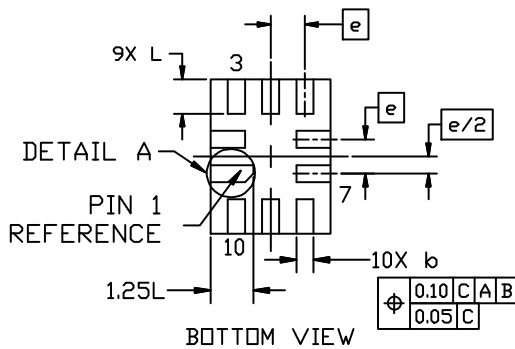
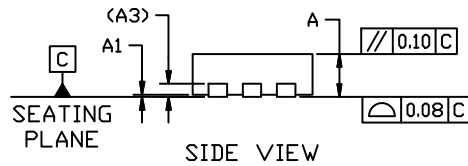
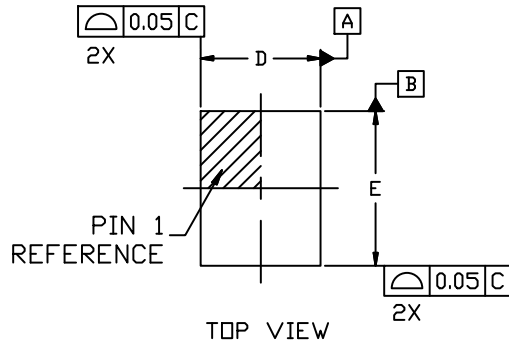

OPTIONAL CONSTRUCTIONS

NOTES:

1. DIMENSIONING AND TOLERANCING PER ASME Y14.5, 2018
2. ALL DIMENSIONS ARE IN MILLIMETERS
3. DIMENSION *b* APPLIES TO PLATED TERMINALS AND IS MEASURED BETWEEN 0.15mm AND 0.30mm FROM THE TERMINAL TIP.
4. COPLANARITY APPLIES TO THE EXPOSED PAD AS WELL AS THE TERMINALS

DIM	MILLIMETERS		
	MIN.	NOM.	MAX.
A	0.45	0.50	0.55
A1	0.00	0.025	0.05
A3	0.152 REF		
<i>b</i>	0.15	0.20	0.25
D	1.35	1.40	1.45
E	1.75	1.80	1.85
<i>e</i>	0.40 BSC		
L	0.35	0.40	0.45

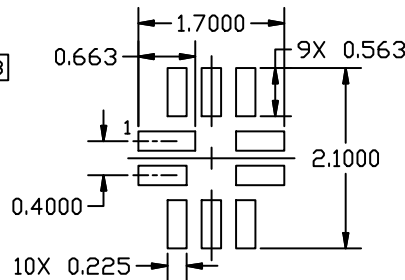

RECOMMENDED LAND PATTERN

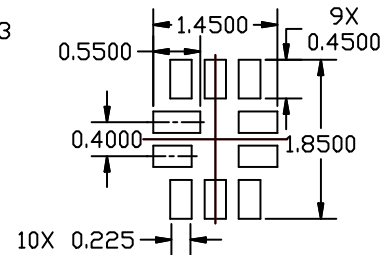

OPTIONAL MINIMAL TOE LAND PATTERN

RECOMMENDED MOUNTING FOOTPRINT

For additional information on our Pb-Free strategy and soldering details, please download the onsemi Soldering and Mounting Techniques Reference Manual, SOLDERRM/D.

<b>DOCUMENT NUMBER:</b>	<b>98AON13705G</b>	Electronic versions are uncontrolled except when accessed directly from the Document Repository. Printed versions are uncontrolled except when stamped "CONTROLLED COPY" in red.
<b>DESCRIPTION:</b>	<b>UQFN10 1.4x1.8, 0.4P</b>	<b>PAGE 1 OF 1</b>

onsemi and ONSEMI are trademarks of Semiconductor Components Industries, LLC dba onsemi or its subsidiaries in the United States and/or other countries. onsemi reserves the right to make changes without further notice to any products herein. onsemi makes no warranty, representation or guarantee regarding the suitability of its products for any particular purpose, nor does onsemi assume any liability arising out of the application or use of any product or circuit, and specifically disclaims any and all liability, including without limitation special, consequential or incidental damages. onsemi does not convey any license under its patent rights nor the rights of others.

**onsemi**, **Onsemi**, and other names, marks, and brands are registered and/or common law trademarks of Semiconductor Components Industries, LLC dba "**onsemi**" or its affiliates and/or subsidiaries in the United States and/or other countries. **onsemi** owns the rights to a number of patents, trademarks, copyrights, trade secrets, and other intellectual property. A listing of **onsemi**'s product/patent coverage may be accessed at [www.onsemi.com/site/pdf/Patent-Marking.pdf](http://www.onsemi.com/site/pdf/Patent-Marking.pdf). **onsemi** reserves the right to make changes at any time to any products or information herein, without notice. The information herein is provided "as-is" and **onsemi** makes no warranty, representation or guarantee regarding the accuracy of the information, product features, availability, functionality, or suitability of its products for any particular purpose, nor does **onsemi** assume any liability arising out of the application or use of any product or circuit, and specifically disclaims any and all liability, including without limitation special, consequential or incidental damages. Buyer is responsible for its products and applications using **onsemi** products, including compliance with all laws, regulations and safety requirements or standards, regardless of any support or applications information provided by **onsemi**. "Typical" parameters which may be provided in **onsemi** data sheets and/or specifications can and do vary in different applications and actual performance may vary over time. All operating parameters, including "Typicals" must be validated for each customer application by customer's technical experts. **onsemi** does not convey any license under any of its intellectual property rights nor the rights of others. **onsemi** products are not designed, intended, or authorized for use as a critical component in life support systems or any FDA Class 3 medical devices or medical devices with a same or similar classification in a foreign jurisdiction or any devices intended for implantation in the human body. Should Buyer purchase or use **onsemi** products for any such unintended or unauthorized application, Buyer shall indemnify and hold **onsemi** and its officers, employees, subsidiaries, affiliates, and distributors harmless against all claims, costs, damages, and expenses, and reasonable attorney fees arising out of, directly or indirectly, any claim of personal injury or death associated with such unintended or unauthorized use, even if such claim alleges that **onsemi** was negligent regarding the design or manufacture of the part. **onsemi** is an Equal Opportunity/Affirmative Action Employer. This literature is subject to all applicable copyright laws and is not for resale in any manner.

## PUBLICATION ORDERING INFORMATION

### LITERATURE FULFILLMENT:

Email Requests to: [orderlit@onsemi.com](mailto:orderlit@onsemi.com)

**onsemi Website:** [www.onsemi.com](http://www.onsemi.com)

### TECHNICAL SUPPORT

**North American Technical Support:**

Voice Mail: 1 800-282-9855 Toll Free USA/Canada

Phone: 011 421 33 790 2910

**Europe, Middle East and Africa Technical Support:**

Phone: 00421 33 790 2910

For additional information, please contact your local Sales Representative